

## Instructions

# Optyma™ Light Commercial

CE and Non-CE: 220-240V, 50Hz

UL and none UL: 208-220V, 60Hz, 115V 60Hz

English / English	p.2
Dansk / Danish	p.5
Deutsch / German	p.8
Français / French	p.11
Español / Spanish	p.14
Svenska / Swedish	p.17
Nederlands / Dutch	p.20
Suomi / Finnish	p.23
العربية / Arabic	p.26

<b>Annex - A</b> Technical data / Tekniske data / Technische Daten / Données techniques / Datos técnicos / Tekniska data / Technische gegevens / Tekniset tiedot / البيانات الفنية	p.29
<b>Annex - B</b> KP switch settings / KP-pressostatindstillinger / KP Schaltereinstellungen / réglages des contacteurs KP / Ajustes de los interruptores KP / KP-brytarinställningar / KP-schakelaar instellingen / KP-kytkinasetukset / إعدادات مفتاح KP	p.74
<b>Annex - C</b> Wiring drawing / Ledningstegning / Schaltplan / schéma de câblage / Diagrama eléctrico / Kabeldragning / Bedradingstekening / KytKentäkaavio / الملحق "ج". مخطط توصيلات الأسلاك	p.101



## Instructions

# Optyma™ Light Commercial



<b>Installation and servicing of the condensing units by qualified personnel only. Follow these instructions and sound refrigeration engineering practice relating to installation, commissioning, maintenance and service.</b>
<b>The condensing unit must only be used for its designed purpose(s) and within its scope of application and according to instruction.</b>
<b>Under all circumstances, the EN378 (or other applicable local safety regulation) requirements must be fulfilled.</b>
<b>The condensing unit must be handled with caution in the vertical position (maximum offset from the vertical : 15°)</b>
<b>Condensing units can be used with refrigerant letter N = R290, necessary care to be taken during installation and servicing.</b>
<b>In case of R290 refrigerants, all components on the refrigeration circuit must be R290 certified. Example: Evaporator.</b>

### Relevant Standards and Directive (CE and non CE)

**EN 378 -2:** Refrigerating Systems And Heat Pumps-Safety And Environmental Requirements.  
**EN 60335-1:** Household And Similar Electrical Appliances – Safety –Part 1: General Requirements  
**Low Voltage Directive n° 2014 / 35 / UE**  
**Machinery Directive n° 2006 / 42 / CE**  
**EC Pressure directive (PED) no. 2014/68/EU**  
**RoHS Directive 2011-65-EU**  
**WEEE Directive 2012-19-EU**  
 (Other local applicable standards)

### 1 – Introduction

**These instructions pertain to Optyma™ Light Commercial range and R290 OP-LCHC, LCQC,MCGC,MCHC,MCHB,LCNC,MCNC,OP-SC,SC,PL,BD,TL,FR,NL,FF,NF,DL used for refrigeration systems**

### 2 – Handling and Storage

- It is recommended not to open the packaging before the unit is at the final place for installation.
- Store and transport the unit in an upright position.
- Store the unit between -35°C and 50°C.
- Don't expose the packaging to rain or corrosive atmosphere.
- Unit store and transport must be in comply with indication on their carton box.

### 3 – Installation

	Do not braze as long as the condensing unit is under pressure.
	It's not allowed to operate the unit in flammable atmosphere.
	Use a drier with molecular sieves suitable for R290 (for versions N0, A09, A11).
	Use only dry and clean components and avoid moisture entering the system.
	Do not lift or move the condensing unit by using copper tubes. Use Rail or base provided

The suction piping connected to the compressor must be flexible in 3 dimensions to dampen vibrations. Furthermore, piping has to be done in such a way that oil return for the compressor is ensured and the risk of liquid slug over in compressor is eliminated.

Installer must carry out risk assessment for flammable refrigerant (R290) applications by referring EN 378 and equivalent European standards.

Installation, maintenance and commissioning must be carried out by qualified specialists only! All connections, example solderings and flare joints, are to be made professionally. Protect the surroundings against admittance of unauthorised persons. Pay attention to sufficient ventilation.

Remove transport safety devices, if any. Mount the condensing unit horizontally. Use the correct tube diameters.

Prevent any vibrations. Avoid smoking and open fire.

Refrigerant is to be removed and disposed of professionally.

#### Assembly of the condensing units

Prepare the tube connections from the evaporator.

It is recommended to use a drier with 3Å molecular sieves, e.g. Danfoss type DML.

Use only dry components and avoid moisture entering the system.

The system components must not contain any chlorine, mineral oil, or other oily substances. Maximum test pressure must not exceed 32 bar.

### 4 – Refrigerant charging

#### Refrigerant charging (N0, N1, N2, T0, T1, T2, A00, A01 and A04)

Annex C Fig.2 The process descriptions below are based on the equipment shown.

1. Suction stop valve
2. Discharge stop valve
3. Connection to suction side
4. Shut-off valve to vacuum pump
5. Shut-off valve to charging cylinder
6. Connection to discharge side

Ensure there is sufficient distance between the condenser coil and surrounding to ensure good air circulation.

Condensing unit must be installed away from moving components, potential source of ignition and high temperature.

The unit ambient temperature shall not exceed 50°C during off cycle.

Ensure that the power supply corresponds to the unit characteristics (See nameplate in unit).

Use clean and dehydrated refrigeration-grade copper tubes and silver alloy brazing material.

7. Shut-off valve to discharge side

8. Shut-off valve to suction side

9. Connection to vacuum pump

10. Connection to charging cylinder

When a vacuum of 0.5 mbar or lower has been reached, shut off the connection to the vacuum pump by closing all manifold valves.

Repeat the evacuating process once or twice if necessary and then close all manifold valves.

Close the service connector of the suction stop valve (1) by turning the spindle „anticlockwise“ to the rear stop.

Refrigerant charging must take place from equipment not contaminated with refrigerants containing chlorine.

For units with stop valves the rule is that refrigerant should always be charged in liquid form through the discharge stop valve of the unit in order to avoid liquid hammer when the unit is started. If this rule cannot be observed the compressor is not to be started until the pressure and the temperature of the refrigerating system have been equalized.

Open valves (5) and (7) of the valve manifold while keeping the other valves closed.

When all liquid has been transferred to the discharge side of the unit close the service connector of the discharge valve (2) by turning the spindle anticlockwise to the rear stop.

Remove all hose connections.

Fit the union nuts with blind caps on pressure gauge connectors (1) and (2).

Fit and tighten up caps on the valve spindles.

### 5 – Evacuation

#### Evacuation (N2, T2, A01 and A04)

Annex C Fig. 2. The process descriptions below are based on the equipment shown.

1. Suction stop valve
2. Discharge stop valve
3. Connection to suction side
4. Shut-off valve to vacuum pump
5. Shut-off valve to charging cylinder
6. Connection to discharge side
7. Shut-off valve to discharge side
8. Shut-off valve to suction side

## Instructions

9. Connection to vacuum pump  
10. Connection to charging cylinder  
Connect the discharge line to the suction stop valve (1) of the unit.

Connect the suction line, via the filter drier, to the discharge stop valve (2).  
Make the connection (3) between the manifold and the service connector of the suction stop valve (1).  
Make the connection (6) between the manifold and the service connector of the discharge stop valve (2).  
Make the connection (9) between the vacuum pump and the manifold (4).  
Make the connection (10) between the charging cylinder and the manifold (5).  
Remove the protective caps from the spindles of both stop valves (1) and (2).  
Open valves (4), (7) and (8). Open stop valves (1) and (2) to mid position. Start the vacuum pump. Vacuum pumps, which are normally used for refrigerants containing chlorine, cannot be used with R134a, R404A/R507 and R452A. Only a vacuum pump with special Polyolester oil may be used for systems with refrigerant containing FCKW, HFCKW and HFKW. (Contact the pump supplier.)

### Evacuation (T0, A00)

Evacuation takes place through the compressor then process connector after complete connection in the refrigerating circuit. Plan sufficient time for the evacuation as it takes place from the low pressure side only, unless additional measures were taken to speed up the evacuation.  
Vacuum pumps normally used for refrigerants containing chlorine must not be used with R134a and R404A/R507. Only a vacuum pump with special Polyolester oil may be used for systems with refrigerant containing FCKW, HFCKW and HFKW. (Contact the pump supplier.)

### 6 – Electrical connections

- Prepare the electrical connections while evacuation is taking place. Do not start the compressor until the vacuum has been broken. Remove the cover over the terminal board. Connect the leads.
- It is impossible to start the unit without a thermostat (1H see Annex C, fig. 2) being connected or a lead between 1 or 2, respectively, and L has been established (Annex C Fig. 3-16).

**Annex C Fig. 3.** Wiring diagram for the compressor platform: P, T, N, F, S.

**Annex C Fig. 4.** Wiring diagram for the compressor platform: SC with CSR (starting and operating capacitor).

**Annex C Fig. 5.** Wiring diagram for the compressor platform: TL, FR and SC condensing units with pressure control.

**Annex C Fig. 6.** Wiring diagram for the compressor platform: SC condensing units with combined high and low pressure control and CSR (starting and operating capacitor).

**Annex C Fig. 7.** Wiring diagram for the compressor platform: MP & ML condensing units.

**Annex C Fig. 8.** Wiring diagram for Twin compressor, see SC.

**Annex C Fig. 9.** Wiring diagram for Twin compressor, with 50% of fan speed.

**Annex C Fig. 10-16.** Wiring diagram for R290 models.

- 1A. Main winding
- 1B. Start winding
- 1C. Start relay
- 1D. Winding protector
- 1E. Start capacitor
- 1F. Bleeder resistance
- 1G. Run capacitor
- 1H. Thermostat
- 1J. Fan
- 1K. Pressure control

### Fit the terminal board cover.

Keep away flammables from the electrical equipment.

### 7 – Declaration of conformity

- All our condensing units are complied with low voltage directive 2014/35/EU and must be incorporated during installation.
- **Low Voltage Directive 2014/35/EU** EN 60335-1:2012 + A11:2014- Household and similar electrical appliances-Safety-Part 1: General requirements-for all above mentioned condensing units with compressor platforms FR, GS, L, P, NF, NL, PL, SC and TL.
- **Eco-design DIRECTIVE 2009/125/EC**, establishing a framework for the setting of Eco-design requirements for energy-related products.
- **REGULATION (EU) 2015/1095**, implementing Eco-design Directive 2009/125/EC with regard to Eco-design requirements for professional refrigerated storage cabinets, blast cabinets, condensing units and process Chiller.
- Condensing unit measurements are made according to standard "EN 13771-2:2007" – Compressor and condensing units for refrigeration-performance testing and test methods- part 2: Condensing units
- The following approvals must be obtained through authorised institutes like Nemko, Demko, BEAB, LCJE, etc. Among others EN 60335-2-24, IEC 335-2-89, IEC 79-15.

### 8 – Safety

#### Important service and safety tips

The drier must always be replaced when a system has been opened.  
Blow through the system with dry nitrogen before soldering.  
When a defective system is emptied the refrigerant must be collected without mixing with other refrigerants, and the refrigerant must not leak into the environment. (See also "Installation").  
The condenser and the complete condensing unit must be cleaned regularly.  
Specified maintenance and cleaning intervals must be observed.  
Working on components that are under pressure is dangerous.  
Beware of hot and extremely cold components.  
Beware of moving components (e.g. fan).  
Pay attention to sufficient ventilation.  
Check the perfect operation of the fan.  
The application limits stated by the manufacturer must be observed.  
If pressure controls are specified, they must be installed professionally.  
The operating condition must be monitored in order to ensure perfect operation.

Check whether the shut-off valves (suction and discharge side) are completely opened. Ensure that EN 378 is observed.

If forced ventilation is necessary, this is to be clearly shown (i.e. by a label).

Do not install in aggressive, moist or dusty environment.

Do not install or start in rooms containing flammable gases or in installations operating with such.

### Pressure Equipment Directive 2014/68/EU EN 378-2:2016

Condensing units are no „units“ in accordance with the PED.

The unit/installation into which the condensing unit is mounted/integrated, must be in accordance with the PED.

### 9 – Maximum refrigerant charges

It is recommended that only the right quantity of refrigerants necessary for correct function of the refrigeration system be added.

For refrigeration systems with capillary tube the charge must be adapted to suit each system type.

The operating charge must never exceed the capacity of condenser and receiver.

Always avoid excess refrigerant charge!

### Crankcase heater

If the maximum amounts of refrigerant cannot be observed in T0, T2, A01, A02, A04 or T0 condensing units respectively, a crankcase heater or a pump-down transmission must be used. The crankcase heater must be fitted directly over the weld.

The crankcase heater will heat the compressor oil during standstill periods. When the refrigeration system has been at a stand-still for longer periods the crankcase heater must be cut in 2-3 hours before starting. The following crankcase heaters are recommended

- TL and FR: 35 W (code no. 192H2095)
- SC: 55W (code no. 192H2096)

### 10 - Cold start

After installing the unit the compressor must be allowed to assume a temperature higher than 10°C before it is started for the first time. This will prevent possible start problems caused by too high oil viscosity.

At lower temperatures some tripping of the winding protector may be expected until the viscosity of the oil becomes reduced.

See also crankcase heater.

Never start during vacuum!

### 11 - Winding protector

The compressors have a built-in winding protector. If the protector cuts out while the compressor is cold it may take approx. 5 minutes for the protector to reset.

If the winding protector cuts out while the compressor is hot (compressor housing above 80°C) up to 45 minutes may pass before the protector resets.

### Checking the winding protector

In the event of a compressor failure a check must be made by resistance measurement direct on the current lead-in to find out whether the fault is due to motor damage or simply a winding protector trip.

Annex C Fig. 3. Location of the winding protector in the electrical circuit.

## Instructions

1A. Main winding  
 1B. Start winding  
 1D. Winding protector  
 If resistance measuring shows that there is a

connection through the motor windings from points K and S of the current lead-in, but a broken circuit between points K and F or between S and F, this indicates that the winding

protector has cut out. Therefore, wait for the protector to reset.

### 12 - ACB Pressostat setting (mini HP/LP)

Application	Refrigerant	High Pressure Setting (bar)		Low pressure Setting (bar)	
		ON	OFF	ON	OFF
LBP	R290	16	20	0.3	-0.4
MBP	R290	10	25	1.7	0.7
LBP	R404A	20	25	-	-
MBP	R134a	13	18	1.5	0.1

### 13 - Dual Pressure Switch Setting

Refrigerants	High pressure settings (bar (g))		Low pressure settings (bar (g))	
	ON	OFF	ON	OFF
R404A/R507/R452A	23	27	2	1
R134a/R513A	13	17	2	1

# Optyma™ Light Commercial



<b>Condensing units må kun monteres og serviceres af uddannet personale. Følg denne vejledning og almindelig køleteknisk praksis i forbindelse med montering, idriftsættelse, vedligeholdelse og servicering.</b>
<b>Condensing unit'en må kun anvendes til det/de formål, den er beregnet til, og inden for dens anvendelsesområde og i henhold til anvisningerne.</b>
<b>Under alle omstændigheder skal EN378 (eller andre gældende lokale sikkerhedsbestemmelser) overholdes.</b>
<b>Condensing unit'en skal håndteres oprejst med forsigtighed (maks. offset fra vertikal: 15°).</b>
<b>Condensing units kan anvendes med kølemiddelbogsstavet N = R290. Der skal udvises den nødvendige forsigtighed ved installation og servicering.</b>
<b>For R290-kølemidler skal alle komponenter i kølekredsløbet være R290-certificerede. Eksempel: Fordamper.</b>

**Relevante standarder og direktiver (CE og ikke-CE)**
**EN 378 -2:** Kølesystemer og varmepumper – Sikkerheds- og miljøkrav.

**EN 60335-1:** Elektriske apparater til husholdningsbrug o.l. – Sikkerhed – Del 1: Generelle krav.

**Lavspændingsdirektivet nr. 2014/35/EU**
**Maskindirektivet nr. 2006/42/EF**
**Trykudstyrsdirektivet (PED) nr. 2014/68/EU**
**RoHS-direktivet 2011/65/EU**
**WEEE-direktivet 2012/19/EU**

(Andre lokale gældende standarder).

**1 – Introduktion**

**Disse instruktioner vedrører Optyma™ Light Commercial-serien og R290 OP-LCHC, LCQC, MCGC, MCHC, MCHB, LCNC, MCNC, OP-SC, SC, PL, BD, TL, FR, NL, FF, NF, DL, der anvendes til køleanlæg**

**2 – Håndtering og opbevaring**

- Det anbefales ikke at åbne emballagen, før enheden er fremme ved dens endelige installationssted.
- Enheden skal opbevares og transporteres i opret stilling.
- Enheden skal opbevares ved temperaturer mellem -35 °C og 50 °C.
- Emballagen må ikke udsættes for regn eller korrosive atmosfærer.
- Opbevaring og transport af enheden skal være i overensstemmelse med angivelserne på papkassen.

**3 – Montering**

	Undlad lodning, så længe condensing unit'en er under tryk.
	Det er ikke tilladt at bruge enheden i brændbar atmosfære.
	Brug et tørrerfilter med molekylsigter, der passer til R290 (for versionerne N0, A09, A11).
	Brug kun tørre og rene komponenter, og undgå, at der kommer fugt i systemet.
	Condensing unit'en må ikke løftes eller flyttes ved hjælp af kobberør. Brug den medfølgende skinne eller sokkel.

Sørg for, at der er tilstrækkelig afstand mellem kondensatorspolen og omgivelserne for at sikre god ventilation.

Condensing unit'en skal installeres på afstand fra bevægelige komponenter, potentielle antændelseskilder og høje temperaturer. Enhedens omgivelsestemperatur må ikke overstige 50 °C, når den er slukket.

Kontrollér, at strømforsyningen svarer til enhedens specifikationer (se typeskiltet på enheden).  
Anvend rene og tørre kølemiddelegnede kobberør og slagloddemateriale med sølvlegering.  
Sugerørføringen, som er forbundet med kompressoren, skal være fleksibel i tre dimensioner for at kunne dæmpe vibrationerne. Derudover skal rørføringen sikre olietilbageføringen til kompressoren og eliminere væskeslag i kompressoren. Installatøren skal udføre risikovurdering for brændbare kølemiddelapplikationer (R290) i henhold til EN 378 og tilsvarende europæiske standarder.

Montering, vedligeholdelse og idriftsættelse må kun udføres af uddannede specialister! Alle tilslutninger, f.eks. lodninger og flare-samlinger, skal udføres professionelt. Sørg for, at uautoriserede personer ikke kan få adgang til området. Vær opmærksom på, at der skal være tilstrækkelig ventilation. Fjern transportsikkerhedsenheder, hvis de er anvendt.  
Monter condensing unit'en vandret. Brug de korrekte rørdiametre. Sørg for at forhindre eventuelle vibrationer. Undgå rygning og åben ild. Kølemidlet skal aftappes og bortskaffes på professionel vis.

**Montering af condensing units**

Klargør rørtilslutningerne fra fordamperen. Det anbefales at bruge en tørrer med 3Å-molekylsigter, f.eks. type DML fra Danfoss. Brug kun tørre komponenter, og undgå, at der kommer fugt i systemet. Systemkomponenterne må ikke indeholde klor, mineralolie eller andre olieholdige stoffer. Maksimal prøvetryk må ikke overstige 32 bar.

**4 – Påfyldning af kølemiddel**
**Påfyldning af kølemiddel (N0, N1, N2, T0, T1, T2, A00, A01 og A04)**

Bilag C, fig. 2. Nedenstående procesbeskrivelser er baseret på det viste udstyr.

1. Sugestopventil
  2. Trykstopventil
  3. Tilslutning til sugeside
  4. Afspærringsventil til vakuumpumpe
  5. Afspærringsventil til påfyldningscylinder
  6. Tilslutning til trykside
  7. Afspærringsventil til trykside
  8. Afspærringsventil til sugeside
  9. Tilslutning til vakuumpumpe
  10. Tilslutning til påfyldningscylinder
- Når et vakuum på 0,5 mbar eller derunder er nået, afbrydes tilslutningen til vakuumpumpen ved at lukke alle manifoldventiler. Gentag tømningssproessen en eller to gange, hvis det er nødvendigt, og luk derefter alle manifoldventiler. Luk servicetilslutningen til sugestopventilen (1) ved at dreje spindlen mod uret til bagerste stopmærke. Kølemidelpåfyldning skal foretages fra udstyr, der ikke er forurenede med klorholdige kølemidler. For enheder med stopventiler er reglen, at kølemidlet altid skal påfyldes i væskeform gennem trykstopventilen på enheden for at undgå væskeslag, når enheden startes. Hvis denne regel ikke kan overholdes, startes kompressoren ikke, før tryk og temperaturen i kølesystemet er trykudlignet. Åbn ventilerne (5) og (7) på ventilmanifolden, samtidig med at de andre ventiler holdes lukkede. Når al væske er overført til enhedens trykside, lukkes servicetilslutningen til afgangventilen (2) ved at dreje spindlen mod uret til bagerste stopmærke. Fjern alle slangetilslutninger. Sæt blindhætter på omløbermøtrikkerne på manometertilslutningerne (1) og (2). Monter og spænd hætter på ventilspindlerne.

**5 – Tømning**
**Tømning (N2, T2, A01 og A04)**

Bilag C, fig. 2. Nedenstående procesbeskrivelser er baseret på det viste udstyr.

1. Sugestopventil
2. Trykstopventil
3. Tilslutning til sugeside
4. Afspærringsventil til vakuumpumpe

## Anleitungen

5. Afspærringsventil til påfyldningscylinder
  6. Tilslutning til trykside
  7. Afspærringsventil til trykside
  8. Afspærringsventil til sugeside
  9. Tilslutning til vakuumpumpe
  10. Tilslutning til påfyldningscylinder
- Tilslut trykledningen på sugestopventilen (1) på enheden.

Tilslut sugeledningen, via filtertørreren, på trykstopventilen (2). Foretag tilslutningen (3) mellem manifolden og servicetilslutningen på sugestopventilen (1). Foretag tilslutningen (6) mellem manifolden og servicetilslutningen på trykstopventilen (2). Foretag tilslutningen (9) mellem vakuumpumpen og manifolden (4). Foretag tilslutningen (10) mellem påfyldningscylinderen og manifolden (5). Fjern beskyttelseshætterne fra spindlerne på begge stopventiler (1) og (2). Åbn ventilerne (4), (7) og (8). Åbn stopventilerne (1) og (2) til midterposition. Start vakuumpumpen. Vakuumpumper, der normalt bruges til kølemidler, der indeholder klor, må ikke anvendes sammen med R134a, R404A/R507 og R452A.

Der må kun bruges en vakuumpumpe med speciel polyolesterolie til systemer med kølemiddel, der indeholder FCKW, HFCKW og HFKW.

(Kontakt pumpeleverandøren).

### Tømning (T0, A00)

Tømning foretages gennem kompressoren og derefter processtudsens efter komplet tilslutning i kølekredsløbet.

Planlæg tilstrækkelig tid til tømningen, da den kun foretages fra lavtryksiden, medmindre der er taget yderligere foranstaltninger til at fremskynde tømningen.

Vakuumpumper, der normalt bruges til klorholdige kølemidler må ikke anvendes sammen med R134a og R404A/R507. Der må kun bruges en vakuumpumpe med speciel polyolesterolie til systemer med kølemiddel, der indeholder FCKW, HFCKW og HFKW. (Kontakt pumpeleverandøren).

### 6 – Elektriske tilslutninger

- Klargør de elektriske tilslutninger, mens tømningen foretages. Start ikke kompressoren, før vakuummet er brudt. Fjern dækslet over klemrækken. Tilslut ledningerne.
- Det er umuligt at starte enheden, uden at der er tilsluttet en termostat (1H, se Bilag C, fig. 2) eller en ledning mellem henholdsvis 1 eller 2, og L er blevet etableret (Bilag C, fig. 3-16).

**Bilag C, fig. 3.** Ledningsdiagram for kompressorplatformen: P, T, N, F, S.

**Bilag C, fig. 4.** Ledningsdiagram for kompressorplatformen: SC med CSR (start- og driftskondensator)

**Bilag C, fig. 5.** Ledningsdiagram for kompressorplatformen: TL, FR og SC condensing units med pressostat.

**Bilag C, fig. 6.** Ledningsdiagram for kompressorplatformen: SC condensing units med kombineret høj- og lavtrykspressostat og CSR (start- og driftskondensator).

**Bilag C, fig. 7.** Ledningsdiagram for kompressorplatformen: MP og ML condensing units.

**Bilag C, fig. 8.** Ledningsdiagram for Twin-kompressor, se SC.

**Bilag C, fig. 9.** Ledningsdiagram for Twin-kompressor med 50 % af ventilatorhastigheden.

**Bilag C, fig. 10-16.** Ledningsdiagram for R290-modeller.

- 1A. Hovedvikling
- 1B. Startvikling
- 1C. Startrelæ
- 1D. Viklingsbeskytter
- 1E. Startkondensator
- 1F. Afladningsmodstand
- 1G. Driftskondensator
- 1H. Termostat
- 1J. Ventilator
- 1K. Pressostat

### Monter dækslet over klemrækken

Hold brændbart materiale på afstand af det elektriske udstyr.

### 7 – Overensstemmelseserklæring

- Alle vores condensing units er i overensstemmelse med Lavspændingsdirektivet 2014/35/EU og skal integreres under monteringen. **Lavspændingsdirektivet 2014/35/EU EN 60335-1:2012 + A11:2014** Elektriske apparater til husholdningsbrug o.l. – Sikkerhed – Del 1: Generelle krav for alle ovenfor nævnte condensing units med kompressorplatformene FR, GS, L, P, NF, NL, PL, SC og TL.
- **Ecodesign-DIREKTIV 2009/125/EF** om rammerne for fastlæggelse af krav til miljøvenligt design af energirelaterede produkter.
- **FORORDNING (EU) 2015/1095**, om gennemførelse af Ecodesign-DIREKTIV 2009/125/EF for så vidt angår krav til miljøvenligt design for professionelle lagerkøleskabe/ lagerfryseskabe, blæsekølere/frysere, kondenseringsaggregater og væskekølere til proceskøling.
- Condensing unit-målinger er udført i henhold til standarden "EN 13771-2:2007" – Kompressorer og kondenserende enheder til køling - Ydeevneprøvning og prøvningsmetoder - Del 2: Condensing units
- Følgende godkendelser skal indhentes hos autoriserede institutter såsom Nemko, Demko, BEAB, LCJE osv. Blandt andet EN 60 335-2-24, IEC 335-2-89, IEC 79-15.

### 8 – Sikkerhed

#### Vigtige tips om service og sikkerhed

Tørreren skal altid udskiftes, når et system har været åbnet.

Blæs systemet igennem med tør nitrogen inden lodning.

Når et defekt system tømmes, skal kølemidlet opsamles uden at blande det med andre kølemidler, og kølemidlet må ikke lække ud i miljøet.

(Se også "Installation").

Kondensatoren og hele condensing unit'en skal rengøres regelmæssigt.

De angivne intervaller for vedligeholdelse og rengøring skal overholdes.

Det er farligt at arbejde på komponenter, der er under tryk.

Vær opmærksom på varme og kolde

komponenter. Vær opmærksom på bevægelige

komponenter (f.eks. ventilator).

Vær opmærksom på, at der skal være tilstrækkelig ventilation.

Kontrollér, at ventilatoren fungerer perfekt.

De anvendelsesgrænser, producenten har angivet, skal overholdes.

Hvis der er specificeret pressostater, skal de monteres på professionel vis. Driftsbetingelserne skal overvåges for at sikre perfekt drift.

Kontrollér, om afspærringsventilerne (suge- og trykside) er helt åbne.

Sørg for, at EN 378 overholdes.

Hvis tvungen ventilation er nødvendig, skal det vises tydeligt (dvs. med en mærkat).

Må ikke monteres i aggressive, fugtige eller støvede miljøer.

Må ikke monteres eller startes i rum, der indeholder brændbare gasser eller

i anlæg, der anvender brændbare gasser.

### Trykregulativet 2014/68/EU EN 378-2:2016

I henhold til PED er condensing units ikke "enheder".

Den enhed/det anlæg, som condensing unit'en monteres/integreres i, skal være i overensstemmelse med PED.

### 9 – Maksimale kølemiddelfyldninger

Det anbefales, at der kun påfyldes den mængde kølemiddel, der er nødvendig for, at kølesystemet fungerer korrekt.

På kølesystemer med kapillarrør skal fyldningen tilpasses, så den passer til hver enkelt systemtype.

Driftsfyldningen må aldrig overstige kondensatorens og receiverens kapacitet.

Undgå altid tilførsel af for meget kølemiddel!

#### Krumtaphusvarmer

Hvis de maksimale kølemiddelmængder ikke kan overholdes i condensing units T0, T2, A01, A02, A04 eller T0, skal der anvendes en krumtaphusvarmer eller pump-down.

Krumtaphusvarmeren skal monteres direkte over svejsningen.

Krumtaphusvarmeren opvarmer kompressorolien under perioder med stilstand.

Når kølesystemet har været i stilstand i længere perioder, skal krumtaphusvarmeren kobles til 2-3 timer før opstart. Følgende krumtaphusvarmere anbefales:

- TL og FR: 35 W (best.nr. 192H2095)
- SC: 55W (best.nr. 192H2096)

### 10 – Koldstart

Efter montering af enheden skal kompressoren opnå en temperatur på over 10 °C, før den startes første gang. Det vil forhindre eventuelle startproblemer på grund af for høj olieviskositet.

Ved lavere temperaturer kan man forvente nogen tripping af viklingsbeskyttelsen, indtil olieviskositeten falder.

Se også krumtaphusvarmer.

Må aldrig startes under vakuum!

### 11 – Viklingsbeskytter

Kompressorerne har en indbygget viklingsbeskytter. Hvis beskytteren kobler ud, mens kompressoren er kold, kan det tage ca. 5 minutter for beskytteren at nulstille.

Hvis viklingsbeskytteren kobler ud, mens kompressoren er varm (kompressorhus over 80 °C), kan det tage op til 45 minutter for beskytteren at nulstille.

## Anleitungen

### Kontrol af viklingsbeskytteren

I tilfælde af kompressorfejl skal der udføres en kontrol ved hjælp af en modstandsmåling direkte på strømindføringen for at finde ud af, om fejlen skyldes motorhavari eller simpelthen trip på viklingsbeskytteren.

Bilag C, fig. 3. Placering af viklingsbeskytteren i det elektriske kredsløb.

- 1A. Hovedvikling
- 1B. Startvikling
- 1D. Viklingsbeskytter

Hvis modstandsmålingen viser, at der er en tilslutning gennem motorviklingerne fra punkt K og S i strømindføringen, men et afbrudt kredsløb mellem punkt K og F, eller mellem S og F, angiver det, at viklingsbeskytteren er udkoblet. Vent derfor på, at beskytteren nulstiller.

### 12 – ACB Pressostat-indstilling (mini HP/LP)

Applikation	Kølemiddel	Højtrykindstilling (bar)		Lavtrykindstilling (bar)	
		ON	OFF	ON	OFF
LBP	R290	16	20	0,3	-0,4
MBP	R290	10	25	1,7	0,7
LBP	R404A	20	25	-	-
MBP	R134a	13	18	1,5	0,1

### 13 – Indstilling af dobbelt pressostat

Kølemidler	Højtrykindstillinger (bar (g))		Lavtrykindstillinger (bar (g))	
	ON	OFF	ON	OFF
R404A/R507/R452A	23	27	2	1
R134a/R513A	13	17	2	1

# Optyma™ Light Commercial



<b>Montage und Wartung der Verflüssigungssätze darf nur durch qualifiziertes Fachpersonal erfolgen. Befolgen Sie diese Anleitung sowie die allgemein gültigen Regeln der Technik für Einbau, Inbetriebnahme, Wartung und Instandhaltung von Kältetechnischen Anlagen.</b>
<b>Der Verflüssigungssatz darf nur für den vorgesehenen Zweck und im entsprechenden Anwendungsbereich gemäß der Anleitung eingesetzt werden.</b>
<b>Die Bestimmungen gemäß EN378 (und alle anderen in Ihrem Land geltenden Sicherheitsvorschriften) müssen unbedingt eingehalten werden.</b>
<b>Der Verflüssigungssatz muss in vertikaler Position montiert werden (maximale Abweichung von der Senkrechten: 15 °).</b>
<b>Verflüssigungssätze können mit dem Kältemittel N (= R290) verwendet werden. Bei Installation und Wartung ist besondere Vorsicht geboten.</b>
<b>Bei R290-Kältemitteln müssen alle Komponenten des Kältekreislaufs für R290 zugelassen sein. Beispiel: Verdampfer .</b>

**Relevante Normen und Richtlinien (CE und andere)**
**EN 378-2:** Kälteanlagen und Wärmepumpen – Sicherheitstechnische und umweltrelevante Anforderungen.

**EN 60335-1:** Sicherheit elektrischer Geräte für den Hausgebrauch und ähnliche Zwecke – Teil 1: Allgemeine Anforderungen.

**Niederspannungsrichtlinie 2014/35/EU**
**Maschinenrichtlinie 2006/42/EG**
**EG-Druckgeräterichtlinie (DGRL) 2014/68/EU**
**RoHS-Richtlinie 2011/65/EU**
**WEEE-Richtlinie 2012/19/EU**

(Örtlich geltende Normen.)

**1 – Einführung**

**Diese Anleitung bezieht sich auf Verflüssigungssätze der Produktreihe Optyma™ Light Commercial, R290 – OP-LCHC, LCQC, MCGC, MCHC, MCHB, LCNC, MCNC, OP-SC, SC, PL, BD, TL, FR, NL, FF, NF, DL – für Kälteanlagen**

**2 – Handhabung und Lagerung**

- Es wird empfohlen, die Verpackung erst am endgültigen Montageort zu öffnen.
- Der Verflüssigungssatz darf nur aufrecht stehend transportiert und gelagert werden.
- Zulässige Lagertemperatur: -35 °C bis 50 °C.
- Die Verpackung darf weder Regen, noch ätzenden Atmosphären ausgesetzt werden.
- Bei Lagerung und Transport des Verflüssigungssatzes sind die Vorgaben auf dem Verpackungskarton zu erfüllen.

**3 – Installation**

	Nicht löten, solange der Verflüssigungssatz unter Druck steht.
	Der Verflüssigungssatz darf nicht in entflammbarer Atmosphäre betrieben werden.
	Verwenden Sie einen Trockner mit Molekularsieb, der für R290 geeignet ist (für Versionen N0, A09, A11).
	Verwenden Sie nur trockene und saubere Komponenten und vermeiden Sie, dass Feuchtigkeit in das System gelangt.
Heben oder bewegen Sie den Verflüssigungssatz nicht an den Kupferrohren. Verwenden Sie die Schienen bzw. die Bodenplatte.	

Sorgen Sie für einen ausreichenden Abstand zwischen dem Verflüssiger und der Umgebung, um eine gute Luftzirkulation zu gewährleisten. Der Verflüssigungssatz muss in ausreichender Entfernung von beweglichen Komponenten, potenziellen Zündquellen und hohen

Temperaturen installiert werden. Im ausgeschalteten Zustand darf die Umgebungstemperatur des Verflüssigungssatzes 50 °C nicht überschreiten.

• Vergewissern Sie sich, dass die Versorgungsspannung den Anforderungen des Verflüssigungssatzes entspricht (siehe Typenschild am Gerät).

Verwenden Sie saubere und trockene für Kältemittel geeignete Kupferrohre und eine Silberlegierung als Lötmaterial. Die an den Verdichter angeschlossene Saugleitung muss in alle 3 Dimensionen flexibel sein, um Vibrationen zu dämpfen. Darüber hinaus muss die Verrohrung so erfolgen, dass der Ölrücklauf zum Verdichter sichergestellt ist und dass das Risiko von Flüssigkeitsschlägen im Verdichter ausgeschlossen ist. Der Monteur muss eine Risikobewertung für Anwendungen mit brennbaren Kältemitteln (R290) unter Bezugnahme auf EN 378 und gleichwertige europäische Normen durchführen. Installation, Wartung und Inbetriebnahme müssen von geschultem Personal durchgeführt werden!

Alle Verbindungen, z. B. Lötstellen, müssen professionell ausgeführt werden.

Schützen Sie die Umgebung gegen das Betreten durch unbefugte Personen. Achten Sie auf ausreichende Belüftung.

Entfernen Sie gegebenenfalls Transportsicherheitsvorrichtungen.

Montieren Sie den Verflüssigungssatz waagrecht. Benutzen Sie die richtigen Rohrdurchmesser.

Vermeiden Sie jegliche Schwingungen. Vermeiden Sie Rauchen und offenes Feuer. Das Kältemittel muss entfernt und professionell entsorgt werden.

**Zusammenbau der Verflüssigungssätze**

Bereiten Sie die Rohrverbindungen des Verdampfers vor.

Es wird empfohlen, einen Trockner mit 3Å Molekularsieben zu verwenden, z. B. Danfoss Typ DML.

Verwenden Sie nur trockene Komponenten

und vermeiden Sie, dass Feuchtigkeit in das System gelangt.

Die Systemkomponenten dürfen weder Chlor, Mineralöl oder andere ölige Stoffe enthalten. Der maximale Prüfdruck darf 32 Bar nicht überschreiten.

**4 – Kältemittelbefüllung**
**Kältemittelbefüllung (N0, N1, N2, T0, T1, T2, A00, A01 und A04)**

Anhang C Abb. 2 Die nachfolgenden Prozessbeschreibungen beruhen auf den dargestellten Geräten.

1. Saugabsperrventil
2. Druckabsperrventil
3. Anschluss an Saugseite
4. Absperrventil zur Vakuumpumpe
5. Absperrventil zum Füllzylinder
6. Anschluss zur Druckseite
7. Absperrventil zur Flüssigkeitsseite
8. Absperrventil zur Saugseite
9. Anschluss zur Vakuumpumpe
10. Anschluss zum Füllzylinder

Wenn ein Vakuum von 0,5 mbar oder niedriger erreicht wurde, sperren Sie den Anschluss zur Vakuumpumpe durch Schließen aller Ventile ab. Wiederholen Sie gegebenenfalls den Evakuierungsvorgang ein- oder zweimal, und schließen Sie dann alle Sammelventile. Schließen Sie den Wartungsanschluss des Saugabsperrventils (1) durch Drehen der Spindel „linksdrehend“ zum nächsten Anschlag. Die Kältemittelbefüllung muss von Geräten aus erfolgen, die nicht mit chlorhaltigen Kältemitteln kontaminiert sind.

Für Einheiten mit Absperrventilen gilt die Regel, dass Kältemittel immer in flüssiger Form durch das Druckabsperrventil der Einheit befüllt werden muss, um beim Starten der Einheit einen Flüssigkeitsschlag zu vermeiden. Wenn diese Regel nicht eingehalten werden kann, wird der Verdichter erst gestartet, wenn Druck und Temperatur des Kühlsystems ausgeglichen wurden.

Öffnen Sie die Ventile (5) und (7) des Ventilblocks und lassen Sie die anderen Ventile geschlossen.



## Instruktionen

Wenn die gesamte Flüssigkeit zur Druckseite der Einheit übertragen wurde, schließen Sie den Wartungsanschluss des Ablassventils (2) durch Drehen der Spindel gegen den Uhrzeigersinn bis zum Anschlag. Entfernen Sie alle Schlauchanschlüsse. Bringen Sie die Überwurfmutter mit Blindkappen an den Manometeranschlüssen (1) und (2) an. Bringen Sie Kappen auf den Ventilspindeln an und ziehen Sie sie fest.

### 5 – Evakuierung

#### Evakuierung (N2, T2, A01 und A04)

Anhang C Abb. 2. Die Prozessbeschreibungen unten beruhen auf den gezeigten Geräten.

1. Saugabsperrventil
  2. Druckabsperrventil
  3. Anschluss an Saugseite
  4. Absperrventil zur Vakuumpumpe
  5. Absperrventil zum Füllzylinder
  6. Anschluss zur Druckseite
  7. Absperrventil zur Flüssigkeitsseite
  8. Absperrventil zur Saugseite
  9. Anschluss zur Vakuumpumpe
  10. Anschluss zum Füllzylinder
- Schließen Sie die Druckschlauch an das Saugabsperrventil (1) der Einheit ein.

Schließen Sie die Saugschlauch über den Filtertrockner an das Flüssigabsperrventil (2) an. Stellen Sie die Verbindung (3) zwischen der Monteurhilfe und dem Wartungsanschluss des Saugabsperrventils (1) her. Stellen Sie die Verbindung (6) zwischen der Monteurhilfe und dem Wartungsanschluss des Flüssigabsperrventils (2) her. Stellen Sie die Verbindung (9) zwischen der Vakuumpumpe und dem Sammelventil (4) her. Stellen Sie die Verbindung (10) zwischen dem Befüllungszyylinder und dem Sammelventil (5) her. Entfernen Sie die Schutzkappen von der Spindel beider Absperrventile (1) und (2). Öffnen Sie die Ventile (4), (7) und (8). Öffnen Sie die Absperrventile (1) und (2) bis zur mittleren Position. Starten Sie die Vakuumpumpe. Vakuumpumpen, die normalerweise für kältemittelhaltiges Chlor verwendet werden, können nicht mit R134a, R404A/R507 und R452A verwendet werden. Nur Vakuumpumpen mit speziellem Polyolesteröl dürfen für Systeme mit Kältemitteln verwendet werden, die FCKW, HFCKW und HFKW enthalten. (Wenden Sie sich an den Pumpenlieferanten.)

#### Evakuierung (T0, A00)

Die Evakuierung erfolgt durch den Verdichter und dann durch den Prozessstutzen nach vollständigem Anschluss im Kältekreislauf. Planen Sie genügend Zeit für die Evakuierung ein, da diese nur von der Niederdruckseite aus erfolgt, sofern nicht zusätzliche Maßnahmen zur Beschleunigung der Evakuierung ergriffen wurden. Vakuumpumpen, die normalerweise im Zusammenhang mit chlorhaltigen Kältemitteln eingesetzt werden, dürfen nicht mit R134a und R404A/R507 verwendet werden. Nur Vakuumpumpen mit speziellem Polyolesteröl dürfen für Systeme mit Kältemitteln verwendet werden, die FCKW, HFCKW und HFKW enthalten. (Wenden Sie sich an den Pumpenlieferanten.)

### 6 – Elektrische Anschlüsse

- Bereiten Sie den elektrischer Anschluss vor, während die Evakuierung stattfindet. Starten Sie den Verdichter erst, wenn das Vakuum gebrochen wurde. Entfernen Sie die Abdeckung über der Klemmenplatte. Schließen Sie die Kabel an.
- Es ist unmöglich, das Gerät zu starten, ohne dass ein Thermostat (1H, siehe Anhang C, Abb. 2) bzw. ein Kabel zwischen 1 oder 2 angeschlossen ist, und L hergestell ist (Anhang C, Abb. 3–16).

**Anhang C Abb. 3.** Schaltplan für die Verdichterplattform: P, T, N, F, S.

**Anhang C Abb. 4.** Schaltplan für die Verdichterplattform: SC mit CSR (Kondensator starten und bedienen).

**Anhang C Abb. 5.** Schaltplan für die Verdichterplattform: TL-, FR- und SC-Verflüssigungssätze mit Druckregelung.

**Anhang C Abb. 6.** Schaltplan für die Verdichterplattform: SC-Verflüssigungssätze mit kombinierter Hoch- und Niederdruckregelung und CSR (Kondensator starten und bedienen).

**Anhang C Abb. 7.** Schaltplan für die Verdichterplattform: MP- & ML-Verflüssigungssätze.

**Anhang C Abb. 8.** Schaltplan für Twin-Verdichter, siehe SC.

**Anhang C Abb. 9.** Schaltplan für Twin-Verdichter mit 50 % der Lüfterdrehzahl.

**Anhang C Abb. 10–16.** Schaltplan für R290-Modelle.

- 1A. Hauptwicklung
- 1B. Hilfswicklung
- 1C. Relais
- 1D. Wicklungsschutz
- 1E. Anlaufkondensator
- 1F. Ableitwiderstand
- 1G. Betriebskondensator
- 1H. Thermostat
- 1J. Lüfter
- 1K. Druckschalter

#### Bringen Sie die Abdeckung der Anschlussbox an

Halten Sie entflammbare Stoffe von elektrischen Geräten fern.

### 7 – Konformitätserklärung

- Alle unsere Verdichtungssätze erfüllen die Vorgaben der Niederspannungsrichtlinie 2014/35/EU und sind während der Installation zu integrieren.
- **Niederspannungsrichtlinie 2014/35/EU** EN60335-1:2012 + A11:2014 – Sicherheit elektrischer Geräte für den Haushalt und ähnliche Zwecke – Teil 1: Allgemeine Anforderungen für alle oben genannten Verflüssigungssätze mit Verdichterplattformen FR, GS, L, P, NF, NL, PL, SC und TL.
- **Ökodesign-Richtlinie 2009/125/EG** „zur Schaffung eines Rahmens für die Festlegung von Anforderungen an energieverbrauchsrelevante Produkte.“
- **VERORDNUNG (EU) 2015/1095**, zur Durchführung der Ökodesign-Richtlinie 2009/125/EG im Hinblick auf die Festlegung von Anforderungen an die umweltgerechte Gestaltung von gewerblichen Kühlagerschränken, Schnellkühlern/-froster, Verflüssigungssätzen und Prozesskühlern.
- Verflüssigungssatzmessungen erfolgen gemäß der Norm „EN 13771-2:2007“

- Verdichter und Verflüssigungssätze für die Kälteanwendung – Leistungsprüfung und Prüfverfahren – Teil 2: Verflüssigungssätze
- Folgende Genehmigungen müssen von autorisierten Instituten wie Nemko, Demko, BEAB LCIE usw. eingeholt werden. Unter anderem EN 60 335-2-24, IEC 335-2-89, IEC 79-15.

### 8. Sicherheit

#### Wichtige Wartungs- und Sicherheitshinweise

Der Trockner muss stets ersetzt werden, wenn ein System geöffnet wurde. Benutzen Sie vor dem Löten trockenen Stickstoff, um das System zu trocknen. Wenn ein defektes System entleert wird, muss das Kältemittel aufgefangen werden, ohne sich mit andern Kältemitteln zu vermischen, und das Kältemittel darf nicht in die Umgebung gelangen. (Siehe auch „Installation“). Der Verflüssiger und der komplette Verflüssigungssatz muss regelmäßig gereinigt werden. Die angegebenen Wartungs- und Reinigungsintervalle sind einzuhalten. Arbeiten an Komponenten, die unter Druck stehen, sind gefährlich. Vorsicht vor heißen und extrem kalten Komponenten. Achten Sie auf bewegliche Komponenten (z. B. Lüfter). Achten Sie auf ausreichende Belüftung. Überprüfen Sie, ob der Lüfter ordnungsgemäß funktioniert. Die vom Hersteller angegebenen Anwendungsgrenzen sind zu beachten. Wenn Druckregler angegeben sind, müssen sie fachgerecht eingebaut werden. Der Betriebszustand muss überwacht werden, um den ordnungsgemäßen Betrieb sicherzustellen. Prüfen Sie, ob die Absperrventile (Saug- und Druckseite) vollständig geöffnet sind. Stellen Sie sicher, dass EN 378 eingehalten wird. Wenn eine Zwangsbelüftung erforderlich ist, muss dies deutlich angezeigt sein (z. B. mit einem Aufkleber). Nicht in aggressiver, feuchter oder staubiger Umgebung installieren. Nicht in Räumen, die entflammbare Gase enthalten, oder in Anlagen, die mit solchen betrieben werden, installieren oder starten. **Druckgeräterichtlinie 2014/68/EU EN 378-2:2016** Die Verflüssigungssätze sind keine „Geräte“ entsprechend der Druckgeräterichtlinie. Die Einheit/Anlage, in die der Verflüssigungssatz eingebaut/integriert wird, muss der Druckgeräterichtlinie entsprechen.

### 9 – Maximale Kältemittelfüllungen

Es wird empfohlen, dass nur die richtige Kältemittelmenge, die für einen ordnungsgemäßen Betrieb des Kühlsystems benötigt wird, eingefüllt wird. Für Kältesysteme mit Kapillarrohr muss die Befüllung je nach Systemtyp angepasst werden. Die Betriebsbefüllung darf nie die Kapazität von Verflüssiger und Empfänger überschreiten. Vermeiden Sie stets Kältemittelüberfüllung! **Kurbelwannenheizung** Wenn die maximale Kältemittelmenge in den Verdichtersätzen T0, T2, A01, A02, A04 bzw.

## Instruktionen

T0 nicht eingehalten werden kann, muss eine Kurbelwannenheizung oder pump down verwendet werden. Die Kurbelwannenheizung muss direkt über der Schweißnaht angebracht werden. Die Kurbelwannenheizung beheizt den Verdichter während Stillständen. Wenn das Kältesystem längere Zeit nicht in Betrieb war, muss die Kurbelwannenheizung 2-3 Stunden vor dem Wiederanlaufen eingeschaltet werden. Folgende Kurbelwannenheizungen werden empfohlen

TL und FR: 35 W (Bestell-Nr. 118U0050)  
 SC: 55 W (Bestell-Nr. 118U0051)

### 10 – Kaltstart

Nach dem Einbau der Einheit muss der Verdichter eine Temperatur über 10 °C erreichen können, bevor er erstmals in Betrieb genommen wird.

So lassen sich eventuelle Startprobleme aufgrund zu hoher Ölviskosität vermeiden. Bei niedrigeren Temperaturen ist mit Ausschalten des Wicklungsschutzes zu rechnen, bis die Viskosität des Öls reduziert wird. Siehe auch „Kurbelwannenheizung“. Nie unter Vakuum starten!

### 11 – Wicklungsschutz

Die Verdichter verfügen über einen eingebauten Wicklungsschutz. Wenn der Wicklungsschutz abschaltet, während der Verdichter kalt ist, kann es ungefähr 5 Minuten dauern, bevor der Schutz zurückgesetzt wird. Wenn der Wicklungsschutz abschaltet, während der Verdichter heiß ist (Verdichtergehäuse über 80°C), kann es bis zu 45 Minuten dauern, bis der Schutz zurückgesetzt wird.

### Prüfung des Wicklungsschutzes

Bei einem Verdichterausfall muss mittels Widerstandsmessung direkt auf dem Stromeingang geprüft werden, ob der Fehler auf einen Motorschaden oder nur auf einen Wicklungsschutz zurückzuführen ist. Anhang C Abb. 3. Anordnung des Wicklungsschutzes im Stromkreis.

1A. Hauptwicklung

1B. Startwicklung

1D. Wicklungsschutz

Wenn die Widerstandsmessung ergibt, dass eine Verbindung durch die Motorwicklungen von den Punkten K und S des Stromeingangs besteht, aber ein unterbrochener Kreis zwischen den Punkten K und F oder zwischen S und F vorliegt, deutet dies auf ein Abschalten des Wicklungsschutzes hin. Warten Sie deshalb, bis sich der Wicklungsschutz zurückgesetzt hat.

### 12 – ACB-Pressostateinstellung (Mini HP/LP)

Anwendung	Kältemittel	Hochdruckeinstellung (bar)		Niederdruckeinstellung (bar)	
		EIN	AUS	EIN	AUS
LBP (Tiefkühlung)	R290	16	20	0,3	-0,4
MBP (Normalkühlung)	R290	10	25	1,7	0,7
LBP (Tiefkühlung)	R404A	20	25	-	-
MBP (Normalkühlung)	R134a	13	18	1,5	0,1

### 13 – Einstellung des Doppeldruckschalters

Kältemittel	Hochdruckeinstellungen (bar)		Niederdruckeinstellungen (bar)	
	EIN	AUS	EIN	AUS
R404A/R507/R452A	23	27	2	1
R134a/R513A	13	17	2	1

# Optyma™ petit tertiaire



<b>L'installation et l'entretien des groupes de condensation doivent être effectués uniquement par du personnel qualifié. Le montage, la mise en service, l'entretien et la maintenance doivent être effectués conformément aux présentes instructions ainsi qu'aux règles de l'art en matière de réfrigération.</b>
<b>Le groupe de condensation doit être utilisé uniquement dans le ou les buts pour lesquels il a été conçu et en respectant sa plage d'utilisation.</b>
<b>Dans tous les cas, il est impératif de respecter les spécifications de la norme EN 378 (ou de toute autre réglementation locale en vigueur en matière de sécurité).</b>
<b>Le groupe de condensation doit être manipulé avec précaution et en position verticale (inclinaison maximale : 15°).</b>
<b>Les groupes de condensation peuvent être utilisés avec des fluides frigorigènes dont la lettre N = R290. Il convient d'être prudent lors de l'installation et de l'entretien.</b>
<b>Dans le cas du fluide frigorigène R290, tous les composants du circuit de réfrigération doivent être certifiés R290. Exemple : Évaporateur.</b>

**Normes et directives pertinentes (CE et non CE)**

**EN 378 -2** : Systèmes de réfrigération et pompes à chaleur - Exigences de sécurité et environnementales.

**EN 60335-1** : Appareils électrodomestiques et analogues - Sécurité - Partie 1 : Exigences générales.

**Directive basse tension n° 2014 / 35 / UE**

**Directive Machines n° 2006 / 42 / CE**

**Directive CE sur les équipements sous pression (DESP) n° 2014/68/UE**

**Directive RoHS 2011/65/UE**

**Directive DEEE 2012-19-EU**

(Autres normes locales applicables.)

1 – Introduction

**Ces instructions concernent la gamme petit tertiaire Optyma™ et R290 OP-LCHC, LCQC, MCGC, MCHC, MCHB, LCNC, MCNC, OP-SC, SC, PL, BD, TL, FR, NL, FF, NF, DL utilisés pour les systèmes de réfrigération**

2 – Manutention et stockage

- Il est recommandé de ne pas ouvrir l'emballage avant d'avoir positionné le groupe à son emplacement d'installation
- Stockez et transportez le groupe en position verticale.
- Stockez le groupe à une température comprise entre -35 °C et 50 °C.
- N'exposez pas l'emballage à la pluie ou à une atmosphère corrosive.
- Le stockage et le transport du groupe doivent être conformes aux indications figurant sur sa boîte en carton.

3 – Installation

	Il ne faut pas braser tant que le groupe de condensation est sous pression.
	Il est interdit d'utiliser le groupe dans une atmosphère inflammable.
	Utilisez un déshydrateur avec tamis moléculaire adapté au R290 (pour les versions N0, A09, A11).
	Utilisez uniquement des composants secs et propres, et empêchez toute humidité extérieure d'entrer dans le système.
	Ne pas soulever ou déplacer le groupe de condensation par les tubes en cuivre. Utiliser le rail ou la base fournis.

Assurez-vous qu'il y a suffisamment de distance entre l'échangeur du condenseur et l'environnement pour assurer une bonne circulation de l'air.

Le groupe de condensation doit être installé à l'écart des composants en mouvement, des sources potentielles d'inflammation et des températures élevées.

La température ambiante d'utilisation du groupe ne doit pas dépasser 50 °C lors du cycle d'arrêt.

Assurez-vous que l'alimentation électrique correspond aux caractéristiques du groupe (voir la plaque signalétique dans le groupe). Utilisez des tubes en cuivre de qualité frigorifique, propres et déshydratés, ainsi que de la brasure à base d'argent.

La tuyauterie d'aspiration raccordée au compresseur doit être flexible dans les 3 dimensions afin d'amortir les vibrations.

En outre, la tuyauterie doit être installée de manière à assurer le retour d'huile du compresseur et à éviter tout risque d'accumulation de liquide dans le compresseur.

L'installateur doit effectuer une évaluation des risques pour les applications de fluide frigorigène inflammable (R290) EN se référant à la norme EN 378 et aux normes européennes équivalentes.

Seuls des spécialistes qualifiés sont autorisés à procéder à l'installation, à la maintenance et à la mise en service !

Tous les raccordements (par exemple brasures et raccords flare) doivent être effectués par des professionnels.

Protéger la zone environnante contre l'intrusion de personnes non autorisées. Veiller à ce que la ventilation soit suffisante.

Retirer les éventuels dispositifs de sécurité utilisés lors du transport.

Monter le groupe de condensation horizontalement. Utiliser des tubes au bon diamètre.

Empêcher les vibrations. Ne pas fumer et éviter les flammes nues.

Le fluide frigorigène doit être retiré et recyclé par des professionnels.

**Montage des groupes de condensation**

Préparez les raccordements des tubes depuis l'évaporateur.

Il est recommandé d'utiliser un déshydrateur avec tamis moléculaire 3Å, par exemple le modèle Danfoss de type DML.

Utiliser uniquement des composants secs et propres, et empêcher toute humidité extérieure d'entrer dans le système.

Les composants du système ne doivent pas contenir de chlore, d'huile minérale ou d'autres substances grasses.

La pression de test maximum ne doit pas dépasser 32 bar.

4 – Charge du fluide frigorigène

**Charge du fluide frigorigène (N0, N1, N2, T0, T1, T2, A00, A01 et A04)**

Annexe C Fig. 2 Les descriptions du processus ci-dessous sont basées sur l'équipement présenté.

1. Vanne d'arrêt de la conduite d'aspiration
2. Vanne d'arrêt de la conduite de refoulement
3. Raccordement à l'aspiration
4. Vanne d'arrêt vers la pompe à vide
5. Vanne d'arrêt vers le cylindre de charge
6. Raccordement au refoulement
7. Vanne d'arrêt vers le refoulement
8. Vanne d'arrêt vers l'aspiration
9. Raccordement à la pompe à vide
10. Raccordement au cylindre de charge

Une fois un niveau vide de 0,5 mbar ou moins atteint, couper le raccordement à la pompe à vide en fermant toutes les vannes du bloc. Répéter la procédure d'évacuation une ou deux fois si nécessaire, puis fermer toutes les vannes du bloc. Fermer le connecteur de maintenance de la vanne d'arrêt de la conduite d'aspiration (1) en tournant la tige dans le sens inverse des aiguilles d'une montre jusqu'à la butée arrière. Charger le fluide frigorigène depuis un équipement non contaminé par des fluides contenant du chlore.

## Instructions

Pour les unités équipées de vannes d'arrêt, le fluide frigorigène doit toujours être chargé sous forme liquide via la vanne d'arrêt de la conduite de refoulement de l'unité, afin d'éviter d'éventuels coups de béliers lors du démarrage de l'unité. Si c'est impossible, ne démarrez pas le compresseur tant que la pression et la température du système de réfrigération n'ont pas été égalisées.

Ouvrez les vannes (5) et (7) du bloc de vannes en laissant les autres vannes fermées. Lorsque tout le liquide a été transféré vers le côté refoulement de l'unité, fermez le connecteur de maintenance de la vanne de refoulement (2) en tournant la tige dans le sens inverse des aiguilles d'une montre jusqu'à la butée arrière. Retirez tous les raccords de flexible.

Placez les écrous-unions avec capuchons borgnes sur les connecteurs de manomètre (1) et (2).

Placez et serrez les capuchons sur les tiges des vannes.

### 5 – Évacuation

#### Évacuation (N2, T2, A01 et A04)

Annexe C Fig. 2. Les descriptions du processus ci-dessous sont basées sur l'équipement présenté.

1. Vanne d'arrêt de la conduite d'aspiration
  2. Vanne d'arrêt de la conduite de refoulement
  3. Raccordement à l'aspiration
  4. Vanne d'arrêt vers la pompe à vide
  5. Vanne d'arrêt vers le cylindre de charge
  6. Raccordement au refoulement
  7. Vanne d'arrêt vers le refoulement
  8. Vanne d'arrêt vers l'aspiration
  9. Raccordement à la pompe à vide
  10. Raccordement au cylindre de charge
- Raccorder la conduite de refoulement à la vanne d'arrêt de la conduite d'aspiration (1) de l'unité.

Raccorder la conduite d'aspiration, via le filtre déshydrateur, à la vanne d'arrêt de la conduite de refoulement (2).

Établir le raccordement (3) entre le bloc de vannes et le connecteur de maintenance de la vanne d'arrêt de la conduite d'aspiration (1). Établissez le raccordement (6) entre le bloc de vannes et le connecteur de maintenance de la vanne d'arrêt de la conduite de refoulement (2). Établir le raccordement (9) entre la pompe à vide et le bloc de vannes (4).

Établir le raccordement (10) entre le cylindre de charge et le bloc de vannes (5). Retirez les capuchons de protection des tiges des deux vannes d'arrêt (1) et (2). Ouvrir les vannes (4), (7) et (8). Ouvrir les vannes d'arrêt (1) et (2) en position intermédiaire. Démarrer la pompe à vide.

Les pompes à vide normalement employées pour les fluides frigorigènes contenant du chlore ne peuvent pas être utilisées avec du R134a, du R404A/R507 et du R452A. Opter pour une pompe à vide avec huile Polyolester spéciale pour des systèmes utilisés avec du fluide frigorigène contenant des CFC, des HCFC ou des HFC. (Contactez le fournisseur de la pompe.)

#### Évacuation (T0, A00)

L'évacuation passe par le compresseur, puis par le connecteur de processus une fois le circuit

de réfrigération complètement raccordé. Prévoir suffisamment de temps pour l'évacuation car celle-ci ne s'effectue que du côté basse pression, sauf si des mesures supplémentaires ont été prises pour l'accélérer. Les pompes à vide normalement employées pour les fluides frigorigènes contenant du chlore ne doivent pas être utilisées avec du R134a et du R404A/R507. Opter pour une pompe à vide avec huile Polyolester spéciale pour des systèmes utilisés avec du fluide frigorigène contenant des CFC, des HCFC ou des HFC. (Contactez le fournisseur de la pompe.)

### 6 – Raccordements électriques

- Préparer les raccordements électriques pendant l'évacuation. Ne pas démarrer le compresseur tant que le dispositif est sous vide. Retirer le couvercle sur la plaque à bornes. Brancher les fils.
- Il est impossible de démarrer l'unité sans qu'un thermostat (1H cf. Annexe C fig. 2) ne soit connecté ou qu'un fil ne relie 1 ou 2 et L (Annexe C fig. 3-16).

**Annexe C Fig. 3.** Schéma électrique pour la plate-forme de compresseur : P, T, N, F, S.

**Annexe C Fig. 4.** Schéma électrique pour la plate-forme de compresseur : SC avec CSR (condensateur de démarrage et de fonctionnement).

**Annexe C Fig. 5.** Schéma électrique pour la plate-forme de compresseur : groupes de condensation TL, FR et SC avec régulateur de pression.

**Annexe C Fig. 6.** Schéma électrique pour la plate-forme de compresseur : groupes de condensation SC avec régulateur de pression combiné haute et basse pression et CSR (condensateur de démarrage et de fonctionnement).

**Annexe C Fig. 7.** Schéma électrique pour la plate-forme de compresseur : groupes de condensation MP & ML.

**Annexe C Fig. 8.** Schéma de câblage pour compresseur double, voir SC.

**Annexe C Fig. 9.** Schéma de câblage pour compresseur double, avec la vitesse du ventilateur à 50 %.

**Annexe C Fig. 10-16.** Schéma de câblage pour les modèles R290.

- 1A. Enroulement principal
- 1B. Enroulement de démarrage
- 1C. Relais de démarrage
- 1D. Protection de l'enroulement interne
- 1E. Condensateur de démarrage
- 1F. Résistance de fuite
- 1G. Condensateur de marche
- 1H. Thermostat
- 1J. Ventilateur
- 1K. Régulateur de pression

#### Positionnez le couvercle de la plaque à bornes

Maintenez les produits inflammables à distance de l'équipement électrique.

### 7 – Déclaration de conformité

- Tous nos groupes de condensation sont conformes à la directive basse tension 2014/35/UE et doivent être intégrés pendant l'installation.
- **Directive basse tension 2014/35/UE** EN 60335-1:2012 + A11:2014 - Appareils électrodomestiques et analogues - Sécurité

- Partie 1 : Exigences générales - pour tous les groupes de condensation mentionnés ci-dessus avec plateformes de compresseur FR, GS, L, P, NF, NL, PL, SC et TL.

- **DIRECTIVE écoconception 2009/125/CE**, établissant un cadre d'exigences en matière d'écoconception applicables aux produits liés à l'énergie.
- **RÈGLEMENT (UE) 2015/1095**, portant application de la directive écoconception 2009/125/CE en ce qui concerne les exigences d'écoconception applicables aux armoires frigorifiques professionnelles, aux cellules de refroidissement et de congélation rapides, aux groupes de condensation et aux refroidisseurs industriels.
- Les mesures des groupes de condensation sont effectuées conformément à la norme « EN 13771-2:2007 » – Compresseurs et unités de condensation pour la réfrigération - Tests de performances et méthodes d'essai - Partie 2 : Groupes de condensation
- Les certifications suivantes doivent être obtenues via des instituts autorisés (Nemko, Demko, BEAB, LCJE, etc.) : EN 60 335-2-24, CEI 335-2-89 et CEI 79-15 notamment.

### 8 – Sécurité

#### Consignes de maintenance et de sécurité importantes

Le déshydrateur doit toujours être remplacé lorsqu'un système a été ouvert.

Souffler de l'azote sec dans le système avant de procéder au soudage.

Lorsqu'un système défectueux est vidangé, collecter le fluide frigorigène sans le mélanger à d'autres fluides et veiller à ce que celui-ci ne s'échappe pas dans l'environnement. (Voir également la section « Installation »).

Nettoyer régulièrement le condenseur et tout le groupe de condensation.

Respecter les intervalles de maintenance et de nettoyage spécifiés.

Il est dangereux de travailler sur des composants sous pression.

Faire attention aux composants extrêmement froids ou chauds. Être vigilant en présence de composants mobiles (e.g. ventilateur).

Veiller à ce que la ventilation soit suffisante.

Vérifier que le ventilateur fonctionne de façon optimale.

Respecter les limites d'application indiquées par le fabricant.

Si des régulateurs de pression sont prescrits, ils doivent être installés par des professionnels.

Surveiller les conditions de fonctionnement pour garantir un fonctionnement optimal.

Vérifier si les vannes d'arrêt (côtés refoulement et aspiration) sont complètement ouvertes.

S'assurer que la norme EN 378 est bien respectée.

Si une ventilation forcée est nécessaire, ceci doit apparaître clairement (e.g. au moyen d'une étiquette).

Ne pas installer dans un environnement agressif, humide ou poussiéreux.

Ne pas installer ni démarrer dans des pièces contenant des gaz inflammables ou dans des installations qui en utilisent.

#### Directive relative aux équipements sous pression 2014/68/UE EN 378-2:2016

Les groupes de condensation ne sont pas des « unités » au sens de la DESP.

## Instructions

L'unité/installation dans laquelle le groupe de condensation est monté/intégré doit être conforme à la directive DESP.

### 9 – Charges maximales de fluide frigorigène

Il est recommandé de n'ajouter que la quantité de fluide frigorigène nécessaire au bon fonctionnement du système de réfrigération. Pour les systèmes de réfrigération à tube capillaire, adaptez la charge au système en présence.

La charge de fonctionnement ne doit jamais dépasser la capacité du condenseur et du réservoir.

Éviter toute surcharge de fluide frigorigène !

#### Résistance de carter

Si les quantités maximales de fluide frigorigène ne peuvent pas être respectées dans les groupes de condensation T0, T2, A01, A02, A04 ou T0, utiliser une résistance de carter ou une « transmission pump-down ». La résistance de carter doit être placée directement au-dessus de la soudure.

La résistance de carter va chauffer l'huile du compresseur pendant les périodes d'arrêt. Après un arrêt prolongé du système de réfrigération,

la résistance de carter doit être activée 2-3 heures avant le démarrage. Les résistances de carter suivantes sont recommandées.

TL et FR : 35 W (code 192H2095)

SC : 55 W (code 192H2096)

### 10 – Démarrage à froid

Une fois l'unité installée, laisser le compresseur atteindre une température supérieure à 10°C avant de le démarrer pour la première fois. Cela empêchera d'éventuels problèmes de démarrage liés à une trop grande viscosité de l'huile.

À des températures plus basses, il est possible que la protection de l'enroulement se déclenche tant que la viscosité de l'huile n'est pas réduite.

Voir également la section « Résistance de carter ». Ne jamais démarrer le dispositif pendant le vide !

### 11 – Protection de l'enroulement

Les compresseurs sont dotés d'une protection d'enroulement intégrée. Si la protection se déclenche lorsque le compresseur est froid, il est possible qu'il lui faille environ 5 minutes pour se réinitialiser.

Si la protection de l'enroulement se déclenche lorsque le compresseur est chaud (enveloppe

du compresseur supérieure à 80°C), la réinitialisation de la protection peut nécessiter jusqu'à 45 minutes.

#### Contrôle de la protection de l'enroulement

En cas de défaillance du compresseur, mesurer la résistance directement sur l'entrée de courant pour déterminer si cette défaillance est due à un endommagement du moteur ou simplement à un déclenchement de la protection de l'enroulement.

Annexe C Fig. 3. Emplacement de la protection de l'enroulement dans le circuit électrique.

1A. enroulement principal

1B. enroulement de démarrage

1D. protection de l'enroulement interne

Si la mesure de la résistance montre qu'une connexion existe entre les enroulements du moteur depuis les points K et S de l'entrée de courant, mais que le circuit est interrompu entre les points K et F ou S et F, cela signifie que la protection de l'enroulement s'est déclenchée. Par conséquent, attendez que la protection se réinitialise.

### 12 – Réglage du pressostat ACB (mini HP/BP)

Application	Réfrigérant	Paramètre de haute pression (bar)		Paramètre de basse pression (bar)	
		ON	OFF	ON	OFF
Basses températures (BT)	R290	16	20	0,3	-0,4
Moyennes températures (MT)	R290	10	25	1,7	0,7
Basses températures (BT)	R404A	20	25	-	-
Moyennes températures (MT)	R134a	13	18	1,5	0,1

### 13 – Réglage du pressostat double

Fluides frigorigènes	Paramètres de haute pression (bar(g))		Paramètres de basse pression (bar(g))	
	ON	OFF	ON	OFF
R404A/R507/R452A	23	27	2	1
R134a/R513A	13	17	2	1

# Optyma™ Light Commercial



<p><b>La instalación y el mantenimiento de la unidad condensadora deben ser llevados a cabo exclusivamente por personal cualificado. Siga estas instrucciones y las adecuadas prácticas de ingeniería de refrigeración, relacionadas con la instalación, puesta en servicio, mantenimiento y servicio técnico.</b></p>
<p><b>La unidad condensadora solo debe utilizarse para los fines para los que ha sido diseñada, dentro de su campo de aplicación y siguiendo las instrucciones.</b></p>
<p><b>Han de cumplirse los requisitos establecidos por la norma EN378 (o cualquier otro reglamento local vigente en materia de seguridad) bajo cualquier circunstancia.</b></p>
<p><b>Manipule la unidad condensadora con precaución y en posición vertical (desviación máxima respecto a la vertical: 15°)</b></p>
<p><b>Las unidades condensadoras pueden utilizarse con refrigerantes con la letra N = R290, por lo que deben extremarse las precauciones durante la instalación y el mantenimiento.</b></p>
<p><b>En el caso de los refrigerantes R290, todos los componentes del circuito de refrigeración deben ser certificados para su uso con refrigerantes R290. Ejemplo: Evaporador.</b></p>

**Normas y directivas pertinentes (CE y no CE)**

**EN 378 -2:** Sistemas de refrigeración y bombas de calor: requisitos de seguridad y medioambientales.

**EN 60335-1:** Aparatos electrodomésticos y análogos. Seguridad. Parte 1: Requisitos generales.

**Directiva de baja tensión n.º 2014/35/UE**

**Directiva de máquinas n.º 2006/42/CE**

**Directiva CE sobre equipos a presión (PED) n.º 2014/68/UE**

**Directiva RoHS 2011/65/UE**

**Directiva WEEE 2012-19-UE**

(Otras normas locales aplicables.)

1 – Introducción

**Estas instrucciones hacen referencia a la gama Optyma™ Light Commercial y a los refrigerantes R290 OP-LCHC, LCQC, MCGC, MCHC, MCHB, LCNC, MCNC, OP-SC, SC, PL, BD, TL, FR, NL, FF, NF, DL utilizados para sistemas de refrigeración**

2 – Manipulación y almacenamiento

- Se recomienda no abrir el embalaje hasta que la unidad se encuentre en el lugar en el que se vaya a proceder a su instalación.
- Almacene y transporte la unidad en posición vertical.
- Almacene la unidad a temperaturas comprendidas entre -35 °C y 50 °C.
- No exponga el embalaje a la lluvia o a atmósferas de carácter corrosivo.
- El almacenamiento y el transporte de la unidad deben cumplir con lo indicado en su caja de cartón.

3 – Instalación

	No realice ningún tipo de soldadura mientras la unidad condensadora se encuentre presurizada.
	No está permitido utilizar la unidad en atmósferas inflamables.
	Use un secador con tamices moleculares adecuados para R290 (para las versiones N0, A09, A11).
	Use únicamente componentes secos y limpios, y evite la entrada de humedad en el sistema.
	No levante ni mueva la unidad condensadora utilizando tubos de cobre. Utilice el raíl o la base suministrados.

Asegúrese de que haya suficiente distancia entre la bobina del condensador y el entorno para garantizar una buena circulación del aire. La unidad condensadora debe instalarse lejos de componentes móviles y de posibles fuente de ignición y altas temperaturas. La temperatura ambiente de la unidad no debe superar los 50°C durante los ciclos de inactividad. Asegúrese de que la fuente de alimentación sea compatible con los requisitos de la unidad (consulte la placa de características de la unidad). Utilice material de soldadura limpio y deshidratado para aleaciones de plata y tubos de cobre para refrigeración. La tubería de aspiración conectada al compresor debe ser flexible en las 3 dimensiones para amortiguar las vibraciones. Además, la tubería debe disponerse de tal forma que el retorno de aceite hacia el compresor esté garantizado y que se evite el riesgo de que se produzcan golpes de líquido en el compresor. El instalador debe llevar a cabo una evaluación de riesgos para las aplicaciones con refrigerantes inflamables (R290), de acuerdo con la norma EN 378 y otras normas europeas equivalentes. Los trabajos de instalación, mantenimiento y puesta en servicio solo podrán ser realizados por especialistas cualificados. Todas las conexiones, por ejemplo, soldaduras y juntas roscadas, deben realizarse de forma profesional. Proteja el entorno contra el acceso de personas no autorizadas. Observe que haya suficiente ventilación. Retire los dispositivos de seguridad para el transporte, si existen. Monte la unidad condensadora en posición horizontal. Use los diámetros de tubo correctos. Evite vibraciones. Evite humo y fuego directo.

El refrigerante debe retirarse y eliminarse de manera profesional.

**Ensamblaje de las unidades condensadoras**

Prepare las conexiones de tubo desde el evaporador. Se recomienda usar un secador con tamiz molecular de 3 Å, p. ej. Danfoss tipo DML. Use únicamente componentes secos y evite la entrada de humedad en el sistema. Los componentes del sistema no deben contener cloro, aceite mineral u otras sustancias aceitosas. La presión de prueba máxima no debe superar los 32 bares.

4 – Carga de refrigerante

**Carga de refrigerante (N0, N1, N2, T0, T1, T2, A00, A01 y A04)**

Anexo C, fig.2 Las siguientes descripciones de proceso se basan en el equipo mostrado.

1. Válvula de cierre en aspiración
2. Válvula de cierre en descarga
3. Conexión al lado de aspiración
4. Válvula de cierre a la bomba de vacío
5. Válvula de cierre al cilindro de carga
6. Conexión al lado de descarga
7. Válvula de cierre al lado de descarga
8. Válvula de cierre al lado de aspiración
9. Conexión a la bomba de vacío
10. Conexión al cilindro de carga

Cuando se haya alcanzado un vacío de 0,5 mbar o inferior, cierre la conexión a la bomba de vacío cerrando todas las válvulas del colector. Repita el proceso de evacuación una o dos veces si es necesario y, a continuación, cierre todas las válvulas del colector. Cierre el conector de servicio de la válvula de cierre de aspiración (1) girando el eje en sentido contrario a las agujas del reloj hasta el cierre posterior.

## Instrucciones

La carga de refrigerante debe realizarse desde un equipo no contaminado con refrigerantes que contengan cloro.

En las unidades con válvulas de cierre, la regla es que el refrigerante siempre debe cargarse en forma líquida a través de la válvula de cierre de descarga de la unidad para evitar un golpe de ariete del líquido cuando se arranque la unidad. Si no puede cumplirse esta regla, no debe arrancarse el compresor hasta que no se hayan compensado la presión y la temperatura del sistema refrigerante. Abra las válvulas (5) y (7) del colector de válvula mientras mantiene las otras válvulas cerradas. Cuando todo el líquido se haya transferido al lado de descarga de la unidad, cierre el conector de servicio de la válvula de descarga (2) girando el eje en sentido contrario a las agujas del reloj hasta el cierre posterior. Retire todas las conexiones de manguera. Coloque las tuercas de unión con tapones ciegos sobre los conectores del manómetro (1) y (2).

Coloque y apriete los tapones en los ejes de válvula.

### 5 – Evacuación

#### Evacuación (N2, T2, A01 y A04)

Anexo C, fig. 2. Las siguientes descripciones de proceso se basan en el equipo mostrado.

1. Válvula de cierre en aspiración
  2. Válvula de cierre en descarga
  3. Conexión al lado de aspiración
  4. Válvula de cierre a la bomba de vacío
  5. Válvula de cierre al cilindro de carga
  6. Conexión al lado de descarga
  7. Válvula de cierre al lado de descarga
  8. Válvula de cierre al lado de aspiración
  9. Conexión a la bomba de vacío
  10. Conexión al cilindro de carga
- Conecte la línea de descarga a la válvula de cierre de aspiración (1) de la unidad.

Conecte la línea de aspiración a la válvula de cierre de descarga (2) a través del secador de filtro.

Establezca la conexión (3) entre el colector y el conector de servicio de la válvula de cierre de aspiración (1).

Establezca la conexión (6) entre el colector y el conector de servicio de la válvula de cierre de descarga (2).

Establezca la conexión (9) entre la bomba de vacío y el colector (4).

Establezca la conexión (10) entre el cilindro de carga y el colector (5).

Retire las tapas protectoras de los ejes de ambas válvulas de cierre (1) y (2).

Abra las válvulas (4), (7) y (8). Abra las válvulas de cierre (1) y (2) en la posición media.

Arranque la bomba de vacío.

Las bombas de vacío que normalmente se usan para refrigerantes que contienen cloro no se pueden usar con R134a, R404A/R507 y R452A.

Solo se puede usar una bomba de vacío con aceite de polioléster especial en sistemas con refrigerante que contienen FCKW, HFCKW y HFKW. (Póngase en contacto con el proveedor de la bomba).

#### Evacuación (T0, A00)

La evacuación se realiza a través del compresor, a continuación de la conexión a proceso,

después de la conexión completa en el circuito de refrigeración.

Planifique suficiente tiempo para la evacuación, ya que solo se realiza desde el lado de baja presión, a menos que se hayan tomado medidas adicionales para acelerar la evacuación. Las bombas de vacío normalmente utilizadas para refrigerantes que contienen cloro no se deben usar con R134a y R404A/R507. Solo se puede usar una bomba de vacío con aceite de polioléster especial en sistemas con refrigerante que contienen FCKW, HFCKW y HFKW. (Póngase en contacto con el proveedor de la bomba).

### 6 – Conexiones eléctricas

- Prepare las conexiones eléctricas mientras se realiza la evacuación. No arranque el compresor hasta que no se haya roto el vacío. Retire la cubierta sobre la placa de terminales. Conecte los cables.
- No se puede arrancar la unidad sin que esté conectado un termostato (1H consulte el Anexo C, Fig. 2) o un puente entre 1 o 2, respectivamente, y se haya establecido L (Anexo C, Fig. 3-16).

**Anexo C, fig. 3.** Diagrama eléctrico para la plataforma del compresor: P, T, N, F, S.

**Anexo C, fig. 4.** Diagrama eléctrico para la plataforma del compresor: SC con CSR (condensador de arranque y funcionamiento).

**Anexo C, fig. 5.** Diagrama eléctrico para la plataforma del compresor: unidades condensadoras TL, FR y SC con control de presión.

**Anexo C, fig. 6.** Diagrama eléctrico para la plataforma del compresor: unidades condensadoras SC con control combinado de alta y baja presión y CSR (condensador de arranque y funcionamiento).

**Anexo C, fig. 7.** Diagrama eléctrico para la plataforma del compresor: unidades condensadoras MP y ML.

**Anexo C, fig. 8.** Diagrama eléctrico para el compresor doble, consulte SC.

**Anexo C, fig. 9.** Diagrama eléctrico para el compresor doble, con un 50 % de la velocidad del ventilador.

**Anexo C, fig. 10-16.** Diagrama eléctrico para los modelos R290.

1A. Devanado principal

1B. Devanado de arranque

1C. Relé de arranque

1D. Protector del devanado

1E. Condensador de arranque

1F. Resistencia de dispersión

1G. Condensador de marcha

1H. Termostato

1J. Ventilador

1K. Control de presión

#### Coloque la tapa de la placa de terminales

Mantenga el equipo eléctrico fuera del alcance del material inflamable.

### 7 – Declaración de conformidad

- Todas nuestras unidades condensadoras cumplen la Directiva sobre baja tensión 2014/35/UE y deben incorporarse durante la instalación.
- **Directiva de Baja Tensión 2014/35/UE** EN 60335-1:2012 + A11:2014: Aparatos electrodomésticos y análogos. Seguridad.

Parte 1: Requisitos generales para todas las unidades condensadoras mencionadas anteriormente con plataformas de compresor FR, GS, L, P, NF, NL, PL, SC y TL.

- **DIRECTIVA sobre Eco-diseño 2009/125/CE**, que establece un marco para determinar los requisitos de Eco-diseño para productos relacionados con la energía.

- **REGULACIÓN (UE) 2015/1095**, que implementa la Directiva sobre Eco-diseño 2009/125/CE en relación con los requisitos de Eco-diseño para armarios profesionales de almacenamiento refrigerado, expositores de enfriamiento rápido, unidades condensadoras y enfriadores de proceso.
- Las mediciones de la unidad condensadora se realizan de acuerdo con la norma «EN 13771-2:2007»: Compresores y unidades condensadoras para pruebas de rendimiento de refrigeración y métodos de prueba, parte 2: Unidades condensadoras
- Las siguientes homologaciones se deben obtener de institutos autorizados como Nemko, Demko, BEAB, LCJE, etc. Las normas EN 60 335-2-24, IEC 335-2-89 y IEC 79-15, entre otras.

### 8 – Seguridad

#### Consejos importantes de mantenimiento y seguridad

El secador siempre se debe sustituir cuando se ha abierto un sistema.

Sople el sistema con nitrógeno seco antes de soldar.

Cuando se vacía un sistema defectuoso, debe recogerse el refrigerante sin mezclarlo con otros refrigerantes; además, no debe filtrarse en el entorno.

(Consulte también la sección «Instalación»). El condensador y toda la unidad condensadora deben limpiarse periódicamente.

Se deben respetar los intervalos de mantenimiento y limpieza especificados.

Es peligroso trabajar en componentes que se encuentran bajo presión.

Tenga cuidado con los componentes calientes y extremadamente fríos. Tenga cuidado con los componentes móviles (p. ej. ventiladores).

Observe que haya suficiente ventilación. Compruebe que el ventilador funcione perfectamente.

Deben cumplirse los límites de aplicación establecidos por el fabricante.

Si se han especificado controles de presión, deben instalarse de forma profesional.

La condición de funcionamiento se debe supervisar con la finalidad de asegurar un funcionamiento perfecto.

Compruebe si las válvulas de cierre (lado de aspiración y de descarga) están abiertas completamente.

Asegúrese de que se cumpla la norma EN 378.

En caso de ser necesaria una ventilación forzada, se debe indicar con claridad (es decir, en una etiqueta).

No instale la unidad en entornos agresivos, húmedos o polvorientos.

No instale o arranque la unidad en cámaras que contengan gases inflamables o en instalaciones que funcionan con ellos.

## Instrucciones

### Directiva de Equipos a Presión 2014/68/UE EN 378-2:2016

Las unidades condensadoras no son «unidades» de acuerdo con la PED.

La unidad/instalación en la que está montada/integrada la unidad condensadora debe satisfacer los requisitos establecidos por la PED.

#### 9 – Cargas máximas de refrigerante

Se recomienda añadir solo la cantidad adecuada de refrigerante que es necesaria para un funcionamiento correcto del sistema de refrigeración.

En el caso de sistemas de refrigeración con tubo capilar, la carga se debe adaptar para que se ajuste a cada tipo de sistema. La carga de funcionamiento nunca debe exceder la capacidad del condensador y el recipiente. Evite siempre exceder la carga de refrigerante.

#### Calentador del cárter

Si no se pueden respetar las cantidades máximas de refrigerante en las unidades condensadoras T0, T2, A01, A02, A04 o T0 respectivamente, se debe utilizar un calentador de cárter o una transmisión de bombeo. El calentador del cárter debe colocarse directamente sobre la soldadura. El calentador del cárter calentará el aceite del compresor durante los periodos de parada.

Si el sistema de refrigeración ha estado parado durante largos periodos, el calentador del cárter debe activarse durante 2-3 horas antes de arrancar. Se recomiendan los siguientes calentadores de cárter

TL y FR: 35 W (código 192H2095)  
SC: 55 W (código 192H2096)

#### 10 – Arranque en frío

Después de instalar la unidad, se debe permitir que el compresor asuma una temperatura superior a los 10 °C antes de ponerlo en marcha por primera vez. Esto evitará posibles problemas de arranque causados por una viscosidad del aceite demasiado elevada. A temperaturas más bajas, se pueden producir disparos del protector de devanado hasta que la viscosidad del aceite se reduzca. Consulte también la sección Calentador del cárter.

Nunca arranque la unidad durante el vacío.

#### 11 – Protector del devanado

Los compresores tienen un protector del devanado integrado. Si el protector se desconecta mientras el compresor está frío, el rearme del protector tardará unos 5 minutos aproximadamente.

Si el protector del devanado se desconecta mientras el compresor está caliente (carcasa del compresor por encima de 80 °C), deben transcurrir hasta 45 minutos antes de rearmar el protector.

#### Comprobación del protector del devanado

Si se produce un fallo del compresor, se realiza una comprobación midiendo la resistencia directamente en la corriente de entrada para ver si el defecto se debe a daños del motor o si simplemente se debe a un disparo del protector del devanado.

Anexo C, fig. 3. Ubicación del protector del devanado en el circuito eléctrico.

1A. Devanado principal  
1B. Devanado de arranque  
1D. Protector del devanado

Si la medición de resistencia muestra que hay una conexión a través de los bobinados del motor desde los puntos K y S de la corriente de entrada, pero hay un circuito abierto entre los puntos K y F o entre S y F, esto indica que el protector del devanado se ha desconectado. Por lo tanto, espere hasta que se rearme el protector.

#### 12 – Ajuste del presostato ACB (mini HP/LP)

Aplicación	Refrigerante	Ajuste de alta presión (bar)		Ajuste de baja presión (bar)	
		ON	OFF	ON	OFF
LBP	R290	16	20	0,3	-0,4
MBP	R290	10	25	1,7	0,7
LBP	R404A	20	25	-	-
MBP	R134a	13	18	1,5	0,1

#### 13 – Ajuste del presostato doble

Refrigerantes	Ajustes de alta presión (bar [g])		Ajustes de baja presión (bar [g])	
	ON	OFF	ON	OFF
R404A/R507/R452A	23	27	2	1
R134a/R513A	13	17	2	1



# Optyma™ Light Commercial



<b>Installation och servicearbete får endast utföras av kvalificerad personal. Följ dessa instruktioner och goda kylningsteknikmetoder vid installation, driftsättning, underhåll och service.</b>
<b>Aggregatet får endast användas i de syften som den är ämnad för och inom dess tilltänkta användningsområden samt enligt anvisningarna.</b>
<b>Under alla omständigheter måste EN378-kraven (eller andra tillämpliga lokala säkerhetsföreskrifter) uppfyllas.</b>
<b>Aggregatet ska hanteras med försiktighet och i upprätt position (maximal förskjutning från upprätt position: 15°) .</b>
<b>Luftkylda aggregat kan användas med köldmedier med bokstaven N = R290. Nödvändig försiktighet måste iaktas vid installation och service.</b>
<b>För R290-köldmedier gäller att alla komponenter i kylkretsen måste vara R290-certifierade. Exempel: Förångare.</b>

**Relevanta standarder och direktiv (CE och icke-CE)**
**SS-EN 378 -2:** Kylningssystem och värmepumpar – Säkerhets- och miljökrav.

**SS-EN 60335-1:** Elektriska hushållsapparater och liknande bruksföremål – Säkerhet – Del 1: Allmänna krav.

**Lågspänningsdirektivet nr 2014/35/EU**
**Maskindirektivet nr 2006/42/EU**
**EG-tryckdirektiv (PED) nr 2014/68/EU**
**RoHS-direktivet 2011/65/EU**
**WEEE-direktivet 2012/19/EU**

(Andra lokala tillämpliga standarder).

**1 – Introduktion**

**Dessa instruktioner gäller Optyma™ Light Commercial-serien och R290 OP-LCHC, LCQC, MCGC, MCHC, MCHB, LCNC, MCNC, OP-SC, SC, PL, BD, TL, FR, NL, FF, NF, DL som används för kylsystem**

**2 – Hantering och lagring**

- Du bör inte öppna förpackningen innan enheten befinner sig på den slutliga installationsplatsen.
- Förvara och transportera enheten i upprätt läge.
- Förvara enheten i temperaturer på mellan -35 °C och 50 °C.
- Utsätt inte förpackningen för regn eller frätande miljöer.
- Förvaring och transport av enheten måste ske i enlighet med anvisningarna på kartongen.

**3 – Installation**

	Använd inte lödutrustning när aggregatet är trycksatt.
	Enheten får inte användas i brandfarlig atmosfär.
	Använd en torkare med Molecular Sieves som passar R290 (för versionerna N0, A09, A11).
	Använd endast torra och rena komponenter och förhindra att fukt kommer in i systemet.
	Lyft eller flytta inte det luftkylda aggregatet med hjälp av kopparrör. Använd medföljande skena eller sockel.

Se till att det finns tillräckligt avstånd mellan kondensornspolen och omgivningen för att säkerställa god luftcirkulation. Luftkylda aggregat måste installeras på avstånd från rörliga komponenter, potentiella användningskällor och höga temperaturer. Enhetens omgivningstemperatur får inte överstiga 50 °C under AV-cykeln. Kontrollera att strömförsörjningen motsvarar

enhetens egenskaper (se typskylten i enheten). Använd rena och vattenfria kopparrör godkända för kylning och silverlegeringsmaterial vid lödning.

Sugledningarna som kopplas till kompressorn måste vara flexibla i 3 dimensioner för att dämpa vibrationer. Rördragningen måste även göras så att oljereturen till kompressorn garanteras och risken för vätskeslag i kompressorn elimineras.

Installatören måste utföra en riskbedömning för tillämpningar med brandfarliga köldmedier (R290) genom att hänvisa till SS-EN 378 och motsvarande europeiska standarder. Installation, underhåll och idriftsättning får endast utföras av kvalificerade specialister! Alla anslutningar, som till exempel lödningar och flare-fogar, måste utföras av fackmän. Håll obehöriga personer på avstånd från omgivningarna. Se noga till att ventilationen är fullgod. Ta bort eventuella transportsäkerhetsanordningar.

Montera kondensoraggregatet horisontellt. Använd rätt rördiametrar. Förhindra eventuella vibrationer. Undvik rökning och öppen eld. Köldmediet ska avlägsnas och kasseras av fackmän.

**Montering av de luftkylda aggregaten**

Förbered röranslutningarna från evaporatorn. Vi rekommenderar att man använder en 3Å Molecular Sieve, t.ex. Danfoss typ DML. Använd endast torra komponenter och förhindra att fukt kommer in i systemet. Systemets komponenter får inte innehålla klor, mineralolja eller andra oljiga ämnen. Det maximala provtrycket får inte överskrida 32 bar.

4. Avstängningsventil till vakuumpump
5. Avstängningsventil till laddningscylinder
6. Anslutning till utsläppssida
7. Avstängningsventil till utsläppssida
8. Avstängningsventil till sugside
9. Anslutning till vakuumpump
10. Anslutning till laddningscylinder

När ett vakuum på 0,5 mbar eller lägre har uppnåtts ska du stänga av anslutningen till vakuumpumpen genom att stänga alla grenrörsventiler. Upprepa evakueringsprocessen en eller två gånger vid behov och stäng därefter alla grenrörsventiler. Stäng servicekontakten för sugstoppventilen (1) genom att vrida spindeln moturs till det bakre stoppet. Fyllning av köldmedium måste ske med utrustning som inte är kontaminerad med köldmedier som innehåller klor. När det gäller aggregat med stoppventiler måste köldmedier alltid fyllas på i flytande form genom hetgasstoppventilen på aggregatet för att förhindra vätskeslag när aggregatet startas. Om detta krav inte går att uppfylla får kompressorn inte startas förrän kylsystemets tryck och temperatur har jämnats ut. Öppna ventilerna (5) och (7) på ventilfördelaren och låt de övriga ventilerna vara stängda. När all vätska har förts till aggregatets utloppssida stänger du hetgasventilens (2) servicekontakt genom att vrida spindeln moturs till det bakre stoppet. Ta bort alla slanganslutningar. Fäst kopplingsmuttrar med täcklock på tryckmätaranslutningarna (1) och (2). Fäst och dra åt locken på ventilspindlarna.

**5 – Evakuering**
**Evakuering (N2, T2, A01 och A04)**

Bilaga C, fig. 2. Processbeskrivningarna nedan är baserade på den utrustning som visas.

1. Sugstoppventil
2. Hetgasstoppventil
3. Anslutning till sugside
4. Avstängningsventil till vakuumpump
5. Avstängningsventil till laddningscylinder

**4 – Fyllning av köldmedium**
**Fyllning av köldmedium (N0, N1, N2, T0, T1, T2, A00, A01 och A04)**

Bilaga C, fig. 2 – Processbeskrivningarna nedan är baserade på den utrustning som visas.

1. Sugstoppventil
2. Hetgasstoppventil
3. Anslutning till sugside

## Instruktioner

6. Anslutning till utsläppssida
  7. Avstängningsventil till utsläppssida
  8. Avstängningsventil till sug sida
  9. Anslutning till vakuumpump
  10. Anslutning till laddningscyllinder
- Anslut utloppsledningen till aggregatets sugavstängningsventil (1).

Anslut sugledningen via torkfiltret till utloppsstopppventilen (2).

Skapa en anslutning (3) mellan fördelaren och sugstopppventilens (1) servicekontakt.

Skapa en anslutning (6) mellan fördelaren och hetgasstopppventilens (2) servicekontakt.

Skapa en anslutning (9) mellan vakuumpumpen och fördelaren (4).

Skapa en anslutning (10) mellan laddningscyllindern och fördelaren (5).

Ta bort skyddskåporna från spindlarna på båda stopppventilerna (1) och (2).

Öppna ventilerna (4), (7) och (8). Öppna stopppventilerna (1) och (2) till mittläget. Starta vakuumpumpen.

Vakuumpumpar som vanligtvis används för köldmedier som innehåller klor får inte användas med R134a, R404A/R507 och R452A. Endast en vakuumpump med specialpolyesterolja får användas för system med köldmedier innehållande FCKW, HFCKW och HFKW. (Kontakta pumpleverantören.)

### Evakuering (T0, A00)

Evakuering sker genom kompressorn och därefter processanslutningenefer komplett anslutning i kylkretsen.

Avsätt tillräckligt med tid för evakueringen eftersom den sker endast från lågtryckssidan, såvida inte ytterligare åtgärder har vidtagits i syfte att se till att evakueringen går snabbare. Vakuumpumpar som vanligtvis används för köldmedier som innehåller klor får inte användas med R134a och R404A/R507. Endast en vakuumpump med specialpolyesterolja får användas för system med köldmedier innehållande FCKW, HFCKW och HFKW. (Kontakta pumpleverantören.)

### 6 – Elektriska anslutningar

- Förbered de elektriska anslutningarna medan evakuering pågår. Starta inte kompressorn förrän vakuumet har brutits. Ta bort kåpan över uttagsplinten. Anslut ledningarna.
- Det är omöjligt att starta aggregatet utan att en termostat (1H, se Bilaga C, fig. 2) är ansluten eller det finns en ledning mellan 1 eller 2 och L har etablerats (Bilaga C, fig. 3-16).

**Bilaga C, fig. 3.** Kopplingsschema för kompressorplattformen: P, T, N, F, S.

**Bilaga C, fig. 4.** Kopplingsschema för kompressorplattformen: SC med CSR (start- och driftkondensator).

**Bilaga C, fig. 5.** Kopplingsschema för kompressorplattformen: Luftkylda aggregat av TL-, FR- och SC-typ med tryckregulator.

**Bilaga C, fig. 6.** Kopplingsschema för kompressorplattformen: Luftkylda aggregat av SC-typ med kombinerad hög- och lågtrycksreglering och CSR (start- och driftkondensator).

**Bilaga C, fig. 7.** Kopplingsschema för kompressorplattformen: Luftkylda aggregat av MP- och ML-typ.

**Bilaga C, fig. 8.** Kopplingsschema för Twinkompressor, se SC.

**Bilaga C, fig. 9.** Kopplingsschema för Twinkompressor, med 50 % av fläkthastigheten.

**Bilaga C, fig. 10-16.** Kopplingsschema för R290-modeller.

1A. Huvudlindning

1B. Startlindning

1C. Startrelä

1D. Lindningsskydd

1E. Startkondensator

1F. Tömningsmotstånd

1G. Drivkondensator

1H. Termostat

1J. Fläkt

1K. Tryckreglering

### Sätt fast kåpan över uttagsplinten

Håll brandfarliga ämnen på avstånd från den elektriska utrustningen.

### 7 – Deklaration om överensstämmelse

- Alla våra luftkylda aggregat uppfyller kraven i lågspänningsdirektivet 2014/35/EU och måste byggas in i samband med installation.
- **Lågspänningsdirektivet 2014/35/EU** SS-EN 60335-1:2012 + A11:2014 – Elektriska hushållsapparater och liknande bruksföremål - Säkerhet - Del 1: Allmänna fordringar för alla ovannämnda luftkylda aggregat med kompressorplattformar FR, GS, L, P, NF, NL, PL, SC och TL.
- **Ekodesigndirektivet 2009/125/EG**, som utgör ett ramverk som fastställer ekodesignkrav för energirelaterade produkter.
- **FÖRORDNING (EU) 2015/1095**, där ekodesigndirektivet 2009/125/EG implementeras avseende ekodesignkrav för kylskåp och frysar för professionellt bruk, snabbnedkylningsskåp, luftkylda aggregat och processkylaggregat.
- Luftkylda aggregat mäts i enlighet med standarden SS-EN 13771-2:2007 – Kylkompressorer och kondensorenheter - Prestandaprovning och provningsmetoder - Del 2: Luftkylda aggregat
- Följande godkännanden måste inhämtas via behöriga auktoriserade institutioner som Nemko, Demko, BEAB, LCJE osv. Bland annat SS-EN 60 335-2-24, IEC 335-2-89, IEC 79-15.

### 8 – Säkerhet

#### Viktiga service- och säkerhetstips

Torkaren måste alltid bytas ut när ett system har öppnats.

Blås igenom systemet med torr kväve före lödning.

När ett defekt system töms måste köldmediet samlas upp utan att blandas med andra köldmedier, och köldmediet får inte läcka ut i omgivningsmiljön. (Se även "Installation").

Kondensorn och hela det luftkylda aggregatet måste rengöras regelbundet. Specificerade underhålls- och rengöringsintervall måste följas.

Arbete på trycksatta komponenter är farligt.

Var uppmärksam på varma och extremt kalla komponenter. Var uppmärksam på rörliga komponenter (t.ex. fläktar).

Se noga till att ventilationen är fullgod.

Kontrollera att fläkten fungerar perfekt.

De tillämpningsgränser som anges av tillverkaren måste följas.

Om tryckregulatorer är specificerade

måste dessa installeras av fackmän.

Drifttillståndet måste övervakas

i syfte att säkerställa perfekt drift.

Kontrollera om avstängningsventilerna (sug- och utsläppssida) är helt öppna.

Säkerställ att SS-EN 378 följs.

Om forcerad ventilation krävs ska detta anges tydligt och klart (t.ex. i form av en etikett).

Installera inte i en aggressiv, fuktig eller dammig miljö.

Installera eller starta inte i rum där antändliga gaser förekommer eller i installationer där antändliga gaser används.

### Pressure Equipment Directive 2014/68/EU EN 378-2:2016

Luftkylda aggregat är inte "enheter" i enlighet med PED.

Den enhet/installation som aggregatet monteras/ byggas in i måste uppfylla kraven i PED.

### 9 – Maximal köldmediefyllning

Vi rekommenderar att man endast fyller på så mycket köldmedium som behövs för att kylsystemet ska fungera korrekt.

För kylsystem med kapillärrör måste fyllningen anpassas efter varje enskild systemtyp.

Fyllningen får aldrig överskrida kondensornas och köldmediebehållarens kapacitet.

Undvik alltid att fylla på för stora mängder köldmedium!

### Vevhusvärmare

Om det inte är möjligt att efterleva maxgränserna för påfyllning av köldmedium i de luftkylda aggregaten T0, T2, A01, A02, A04 respektive T0 måste en vevhusvärmare eller en nedpumpningsöverföring användas.

Vevhusvärmaren måste monteras precis ovanför svetsningen.

Vevhusvärmaren värmer upp kompressoroljan under stilleståndperioder. När kylsystemet har varit stillastående under längre perioder måste vevhusvärmaren kopplas in 2–3 timmar före start. Följande vevhusvärmare rekommenderas:

TL och FR: 35 W (kodnr 192H2095)

SC: 55 W (kodnr 192H2096)

TL och FR: 35 W (kodnr 192H2095)

SC: 55 W (kodnr 192H2096)

TL och FR: 35 W (kodnr 192H2095)

SC: 55 W (kodnr 192H2096)

TL och FR: 35 W (kodnr 192H2095)

SC: 55 W (kodnr 192H2096)

TL och FR: 35 W (kodnr 192H2095)

SC: 55 W (kodnr 192H2096)

TL och FR: 35 W (kodnr 192H2095)

SC: 55 W (kodnr 192H2096)

TL och FR: 35 W (kodnr 192H2095)

SC: 55 W (kodnr 192H2096)

TL och FR: 35 W (kodnr 192H2095)

SC: 55 W (kodnr 192H2096)

TL och FR: 35 W (kodnr 192H2095)

SC: 55 W (kodnr 192H2096)

TL och FR: 35 W (kodnr 192H2095)

SC: 55 W (kodnr 192H2096)

TL och FR: 35 W (kodnr 192H2095)

SC: 55 W (kodnr 192H2096)

TL och FR: 35 W (kodnr 192H2095)

SC: 55 W (kodnr 192H2096)

TL och FR: 35 W (kodnr 192H2095)

SC: 55 W (kodnr 192H2096)

TL och FR: 35 W (kodnr 192H2095)

SC: 55 W (kodnr 192H2096)

TL och FR: 35 W (kodnr 192H2095)

SC: 55 W (kodnr 192H2096)

TL och FR: 35 W (kodnr 192H2095)

SC: 55 W (kodnr 192H2096)

TL och FR: 35 W (kodnr 192H2095)

SC: 55 W (kodnr 192H2096)

TL och FR: 35 W (kodnr 192H2095)

SC: 55 W (kodnr 192H2096)

TL och FR: 35 W (kodnr 192H2095)

SC: 55 W (kodnr 192H2096)

TL och FR: 35 W (kodnr 192H2095)

SC: 55 W (kodnr 192H2096)

## Instruktioner

Bilaga C, fig. 3. Lindningsskyddets placering i elkretsen.

1A. Huvudvarv

1B. Startlindning

1D. Lindningsskydd

Om motståndsmätningen visar att det finns en anslutning genom motorlindningarna från punkterna K och S på strömkabeln,

men en trasig krets mellan punkterna K och F eller mellan punkterna S och F, så indikerar detta att lindningsskyddet har löst ut. Invänta därför att skyddet återställs.

### 12 – ACB-pressostatinställning (mini HP/LP)

Tillämpning	Köldmedium	Inställning för högt tryck (bar)		Inställning för lågt tryck (bar)	
		PÅ	AV	PÅ	AV
LBP	R290	16	20	0,3	-0,4
MBP	R290	10	25	1,7	0,7
LBP	R404A	20	25	-	-
MBP	R134a	13	18	1,5	0,1

### 13 – Inställning av dubbel pressostat

Köldmedier	Inställningar för högt tryck (bar (g))		Inställningar för lågt tryck (bar (g))	
	PÅ	AV	PÅ	AV
R404A/R507/R452A	23	27	2	1
R134a/R513A	13	17	2	1

# Optyma™ Light Commercial



**Installatie en onderhoud van de koelgroepen mag alleen worden uitgevoerd door deskundig personeel. Volg deze instructies en pas standaard koeltechnische werkwijzen toe ten aanzien van installatie, inbedrijfstelling, service en onderhoud.**

**De koelgroep mag uitsluitend worden gebruikt waarvoor hij is ontworpen en binnen het toepassingsbereik en volgens instructie.**

**Onder alle omstandigheden moet worden voldaan aan de vereisten van EN378 (of andere lokale veiligheidsvoorschriften).**

**Ga voorzichtig om met de koelgroep in verticale positie (maximale uitwijking van de verticale positie: 15°).**

**Koelgroepen kunnen worden gebruikt met koudemiddelletter N = R290; wees voorzichtig tijdens installatie en onderhoud.**

**Bij R290-koelmiddelen moeten alle componenten in het koelcircuit R290-gecertificeerd zijn. Voorbeeld: Verdampfer.**

## Relevante normen en richtlijn (CE en niet-CE)

**EN 378 -2:** Koelsystemen en warmtepompen – Veiligheids- en milieuevereisten.

**EN 60335-1:** Huishoudelijke en soortgelijke elektrische toestellen – Veiligheid – Deel 1: Algemene vereisten.

**Laagspanningsrichtlijn nr. 2014/35/UE**

**Machinerichtlijn nr. 2006/42/CE**

**EG-richtlijn drukapparatuur (PED) nr. 2014/68/EU**

**BGGG-richtlijn 2011/65/EU**

**AEEA-richtlijn 2012/19/EU**

(Andere lokale toepasselijke normen.)

### 1 – Inleiding

**Deze instructies zijn van toepassing op het Optyma™ Light Commercial-assortiment en R290 OP-LCHC, LCQC, MCGC, MCHC, MCHB, LCNC, MCNC, OP-SC, SC, PL, BD, TL, FR, NL, FF, NF, DL gebruikt voor koelsystemen**

### 2 – Hantering en opslag

- Wij raden u aan de verpakking pas te openen als het apparaat zich in de ruimte bevindt waar u het wilt installeren.
- Bewaar en transporteer het apparaat rechtopstaand.
- Bewaar het apparaat tussen -35 °C en 50 °C.
- Stel de verpakking niet bloot aan regen of een corroderende atmosfeer.
- De opslag en het transport van de eenheid moeten voldoen aan de indicatie op de kartonnen doos.

### 3 – Installatie

	Niet solderen zolang de koelgroep onder druk staat.
	Het is niet toegestaan om het apparaat in een ontvlambare atmosfeer te gebruiken.
	Gebruik een droger met moleculaire zeef die geschikt is voor R290 (voor uitvoering N0, A09, A11).
	Gebruik uitsluitend droge en schone componenten en voorkom dat er vocht in het systeem komt.
	Til of verplaats de koelgroep niet aan de koperen buizen. Gebruik de meegeleverde rail of grondplaat.

Zorg voor voldoende afstand tussen de condensor en de omgeving om een goede luchtcirculatie te waarborgen. De koelgroep moet uit de buurt van bewegende onderdelen, potentiële ontstekingsbronnen en hoge temperaturen worden geïnstalleerd. De omgevingstemperatuur rond het apparaat mag nooit meer dan 50 °C bedragen tijdens de uit-cyclus.

Zorg ervoor dat de voeding overeenkomt met de eigenschappen van het apparaat (zie naamplaatje in unit). Gebruik schone en gedehydrateerde koperen buizen van koelkwaliteit en soldeermateriaal van zilverlegering. De zuigleiding die wordt aangesloten op de compressor moet flexibel zijn in 3 richtingen om trillingen te dempen. De leidingen moeten bovendien worden geïnstalleerd zodat de olie goed terugkeert naar de compressor en het risico op vloeistofslag in de compressor geëlimineerd wordt.

De installateur moet een risicobeoordeling uitvoeren voor toepassingen met brandbaar koelmiddel (R290) volgens EN 378 en gelijkwaardige Europese normen. Installatie, onderhoud en inbedrijfstelling mogen uitsluitend worden uitgevoerd door bevoegde specialisten!

Alle aansluitingen, zoals solderingen en flareverbindingen, moeten door vakbekwaam personeel worden uitgevoerd. Beveilig de omgeving tegen toegang door onbevoegde personen. Zorg voor voldoende ventilatie.

Verwijder transportbeveiligingen, waar van toepassing. Monteer de koelgroep horizontaal. Gebruik de juiste leidingdiameters. Voorkom trillingen. Voorkomen roken en open vuur. Koudemiddel moet door vakbekwaam personeel worden verwijderd en afgevoerd.

**De koelgroepen monteren**  
Bereid de leidingaansluitingen van de verdampfer voor.

We adviseren om een droger te gebruiken met een moleculaire zeef van 3Å, zoals Danfoss type DML. Gebruik uitsluitend droge componenten en voorkom dat er vocht in het systeem komt. De systeemcomponenten mogen geen chloor, minerale olie of andere olieachtige stoffen bevatten. De maximale testdruk mag niet hoger zijn dan 32 bar.

### 4 – Vullen met koudemiddel

**Vullen met koudemiddel (N0, N1, N2, T0, T1, T2, A00, A01 en A04)**

Bijlage C Fig. 2 De onderstaande procesbeschrijvingen zijn gebaseerd op de weergegeven apparatuur.

1. Zuigafsluiter
2. Persafsluiter
3. Aansluiting naar zuigzijde
4. Afsluiter naar vacuümpomp
5. Afsluiter naar vulcilinder
6. Aansluiting naar perszijde
7. Afsluiter naar perszijde
8. Afsluiter naar zuigzijde
9. Aansluiting naar vacuümpomp
10. Aansluiting naar vulcilinder

Wanneer een vacuüm van 0,5 mbar of lager is bereikt, sluit u de aansluiting naar de vacuümpomp door alle verdeelafsluiters te sluiten. Herhaal het vacumeringsproces zo nodig een of twee keer en sluit vervolgens alle verdeelafsluiters. Sluit de serviceconnector van de zuigafsluiter (1) door de spindel linksom naar de achterstop te draaien. Het vullen met koudemiddel moet worden uitgevoerd met behulp van apparatuur die niet is verontreinigd met chloorhoudende koudemiddelen.

Voor units met afsluiters geldt de regel dat het koudemiddel altijd in vloeibare vorm via de persafsluiter van de unit moet worden gevuld om vloeistofslag bij het starten van de unit te voorkomen. Als dat niet mogelijk is, mag de compressor pas worden gestart als de druk en temperatuur van het koelsysteem zijn vereffend. Open afsluiters (5) en (7) van de afsluiterverdeelleiding en houd de andere afsluiters gesloten.

Wanneer alle vloeistof naar de perszijde van de unit is overgebracht, sluit u de serviceconnector van de persafsluiter (2) door de spindel linksom naar de achterstop te draaien. Verwijder alle slang aansluitingen. Breng de wartelmoeren met blinde doppen aan op manometerconnector (1) en (2). Plaats de doppen op de afsluiterspindels en draai ze vast.

## Instructies

### 5 – Vacumeren

#### Vacumeren (N2, T2, A01 en A04)

Bijlage C Fig. 2. De onderstaande procesbeschrijvingen zijn gebaseerd op de weergegeven apparatuur.

1. Zuigafsluiter
  2. Persafsluiter
  3. Aansluiting naar zuigzijde
  4. Afsluiter naar vacuümpomp
  5. Afsluiter naar vulcilinder
  6. Aansluiting naar perszijde
  7. Afsluiter naar perszijde
  8. Afsluiter naar zuigzijde
  9. Aansluiting naar vacuümpomp
  10. Aansluiting naar vulcilinder
- Sluit de persleiding aan op de zuigafsluiter (1) van de unit.

Sluit de zuigleiding via de filterdroger aan op de persafsluiter (2).

Maak de aansluiting (3) tussen de verdeelconnector en de serviceconnector van de zuigafsluiter (1).

Maak de aansluiting (6) tussen de verdeelconnector en de serviceconnector van de persafsluiter (2).

Maak de aansluiting (9) tussen de vacuümpomp en de verdeelleiding (4).

Maak de aansluiting (10) tussen de vulcilinder en de verdeelleiding (5).

Verwijder de beschermdoppen van de spindels van afsluiter (1) en (2).

Open afsluiter (4), (7) en (8). Open afsluiter (1) en (2) tot de middenpositie. Start de vacuümpomp.

Vacuümpompen die gewoonlijk worden gebruikt voor chloorhoudende koudemiddelen, kunnen niet worden gebruikt met R134a, R404A/R507 en R452A.

Alleen een vacuümpomp met speciale polyolesterolie mag worden gebruikt bij systemen met koudemiddel dat FCKW, HFCKW en HFKW bevat. (Neem contact op met de pompleverancier.)

#### Vacumeren (T0, A00)

Het vacumeren verloopt via de compressor en vervolgens via de procesaansluiting na volledige aansluiting op het koelcircuit. Plan voldoende tijd voor het vacumeren, aangezien dat alleen plaatsvindt aan de lagedrukzijde, tenzij er aanvullende maatregelen zijn genomen om het vacumeren te versnellen. Vacuümpompen die gewoonlijk worden gebruikt voor chloorhoudende koudemiddelen, kunnen niet worden gebruikt met R134a en R404A/R507. Alleen een vacuümpomp met speciale polyolesterolie mag worden gebruikt bij systemen met koudemiddel dat FCKW, HFCKW en HFKW bevat. (Neem contact op met de pompleverancier.)

### 6 – Elektrische aansluitingen

- Bereid de elektrische aansluitingen voor terwijl de vacumering plaatsvindt. Start de compressor pas als het vacuüm is opgeheven. Verwijder de afdekking van het klemmenblok. Sluit de kabels aan.
- Het is niet mogelijk om de unit te starten zonder dat er een thermostaat (1H zie Bijlage C, Fig. 2) is aangesloten of zonder dat er een kabel tussen 1 of 2 is aangesloten, en zonder dat L is gerealiseerd (Bijlage C Fig. 3-16).

**Bijlage C Fig. 3.** Bedradingsschema voor het compressorplatform: P, T, N, F, S.

**Bijlage C Fig. 4.** Bedradingsschema voor het compressorplatform: SC met CSR (start- en bedrijfscondensator).

**Bijlage C Fig. 5.** Bedradingsschema voor het compressorplatform: TL, FR en SC koelgroepen met pressostaat.

**Bijlage C Fig. 6.** Bedradingsschema voor het compressorplatform: SC koelgroepen met gecombineerde hoge- en lagedrukpressostaat en CSR (begin- en bedrijfscondensator).

**Bijlage C Fig. 7.** Bedradingsschema voor het compressorplatform: MP & ML koelgroepen.

**Bijlage C Fig. 8.** Bedradingsschema voor dubbele compressor, zie SC.

**Bijlage C Fig. 9.** Bedradingsschema voor dubbele compressor, met 50% van ventilatorsnelheid.

**Bijlage C Fig. 10-16.** Bedradingsschema voor R290-modellen.

- 1A. Hoofdwikkeling
- 1B. Startwikkeling
- 1C. Startrelais
- 1D. Wickelbeveiliging
- 1E. Startcondensator
- 1F. Afleidweerstand
- 1G. Bedrijfscondensator
- 1H. Thermostaat
- 1J. Ventilator
- 1K. Drukregeling

#### Bevestig de afdekking van het klemmenblok

Houd ontvlambare materialen uit de buurt van de elektrische apparatuur.

### 7 – Conformiteitsverklaring

- Al onze koelgroepen voldoen aan de laagspanningsrichtlijn 2014/35/EU en moeten tijdens de installatie worden geïntegreerd.
- **Laagspanningsrichtlijn 2014/35/EU** EN 60335-1:2012 + A11:2014- Huishoudelijke en gelijksoortige elektrische apparaten- Veiligheid-Deel 1: Algemene eisen – voor alle hierboven vermelde koelgroepen met compressorplatform FR, GS, L, P, NF, NL, PL, SC en TL.
- **Ecodesign-richtlijn 2009/125/EG**, betreffende de totstandbrenging van een kader voor het vaststellen van eisen inzake ecologisch ontwerp voor energiegerelateerde producten.
- **VERORDENING (EU) 2015/1095**, tot uitvoering van Richtlijn 2009/125/EG inzake ecologisch ontwerp voor professionele koelbewaarkasten, snelkoelers/-vriezers, koelgroepen en proces-chillers.
- Prestatiemetingen van koelgroepen zijn uitgevoerd volgens de norm EN 13771-2:2007 – Compressoren voor koelmiddelen en koelgroepen – Prestatiebeproeving en beproevingsmethoden – Deel 2: Condensorunits
- De volgende goedkeuringen moeten worden verkregen via officiële keuringsinstanties zoals Nemko, Demko, BEAB, LCJE enz. Onder meer EN 60335-2-24, IEC 335-2-89, IEC 79-15.

### 8 – Veiligheid

#### Belangrijke onderhouds- en veiligheidstips

De droger moet altijd worden vervangen wanneer een systeem is geopend.

Blaas het systeem door met droge stikstof voordat u gaat solderen.

Wanneer een defect systeem wordt gelegeed, moet het koudemiddel apart worden verzameld. Het mag niet worden vermengd met andere koudemiddelen en het mag niet naar de omgeving lekken. (Zie ook 'Installatie').

De condensator en de volledige koelgroep moeten regelmatig worden gereinigd.

Volg de gespecificeerde onderhouds- en reinigingsintervallen altijd op.

Werken aan componenten die onder druk staan, is gevaarlijk.

Let op voor hete en extreem koude componenten. Let op voor bewegende componenten (bv. ventilator).

Zorg voor voldoende ventilatie.

Controleer of de ventilator optimaal werkt.

Houd u aan de toepassingslimieten die door de fabrikant worden vermeld.

Als er pressostaten zijn gespecificeerd, moeten die door vakbekwaam personeel worden geïnstalleerd.

De bedrijfscondities moeten worden bewaakt om een optimale werking te garanderen.

Controleer of de afsluiters (zuig- en perszijde) volledig zijn geopend.

Zorg dat er wordt voldaan aan EN 378.

Als geforceerde ventilatie noodzakelijk is, moet dat duidelijk worden aangegeven (d.w.z. met een label).

Niet installeren in agressieve, vochtige of stoffige omgeving.

Niet installeren of starten in ruimtes met ontvlambare gassen of in installaties die daarmee werken.

#### Richtlijn drukapparatuur 2014/68/EU EN 378-2:2016

Koelgroepen zijn geen "units" volgens de PED. De unit/installatie waarin de koelgroep is gemonteerd/geïntegreerd, moet aan de PED voldoen.

### 9 – Maximale koudemiddelvulling

We adviseren om niet meer koudemiddel toe te voegen dan nodig is voor een juiste werking van het koelsysteem.

Voor koelsystemen met capillair moet de vulling worden aangepast aan het specifieke systeemtype.

De bedrijfsvulling mag nooit meer zijn dan de capaciteit van de condensator en het vloeistofvat.

Vermijd altijd een te grote hoeveelheid koudemiddelvulling!

#### Carterverwarming

Als het niet mogelijk is de aangegeven maximale hoeveelheid koudemiddel in de koelgroepen T0, T2, A01, A02, A04 of T0 aan te houden, moet er een carterverwarming of pumpdown-transmissie worden gebruikt. De carterverwarming moet direct over de las worden geplaatst. De carterverwarming verwarmt de compressorolie tijdens stilstandperiodes. Wanneer het koelsysteem gedurende langere tijd stilstaat, moet de carterverwarming 2-3 uur vóór het starten worden ingeschakeld.

De volgende carterverwarmingen worden aanbevolen

- TL en FR: 35 W (bestelnr. 192H2095)
- SC: 55 W (bestelnr. 192H2096)

## Instructies

### 10 – Koude start

Na het installeren van de unit moet de compressor een temperatuur van meer dan 10 °C bereiken voordat u de unit voor het eerst opstart. Dat voorkomt mogelijke startproblemen die worden veroorzaakt door een te hoge viscositeit van de olie. Bij lagere temperaturen is activering van de wikkelingbeveiliging te verwachten, totdat de viscositeit van de olie afneemt. Zie ook Carterverwarming. Nooit tijdens vacuüm starten!

### 11 – Wikkelingbeveiliging

De compressoren hebben een ingebouwde wikkelingbeveiliging. Als de beveiliging de motor uitschakelt terwijl de compressor koud is, kan het circa 5 minuten duren voordat de beveiliging wordt gereset. Als de wikkelingbeveiliging de motor uitschakelt terwijl de compressor heet is (compressorbehuizing boven 80 °C), kan het circa 45 minuten duren voordat de beveiliging wordt gereset.

**De wikkelingbeveiliging controleren**  
Bij uitval van de compressor kunt u door middel van een weerstandsmeting direct op de toevoerstroombaad bepalen of

de fout het gevolg is van schade aan de motor of van activering van de wikkelingbeveiliging. Bijlage C Fig. 3. Locatie van de wikkelingbeveiliging in het elektrische circuit.

1A. Hoofdwickeling  
1B. Startwickeling  
1D. Wikkelingbeveiliging

Als uit de weerstandsmeting blijkt dat er een doorverbinding door de motorwikkelingen bestaat van punt K en S van de stroomtoevoer, terwijl de verbinding tussen punt K en F of tussen punt S en F verbroken is, weet u dat de wikkelingbeveiliging het circuit heeft uitgeschakeld. Wacht in dat geval totdat de beveiliging wordt gereset.

### 12 – ACB-pessostaatinstelling (mini HP/LP)

Toepassing	Koudemiddelen	Hogedrukinstelling (bar)		Lagedrukinstelling (bar)	
		AAN	UIT	AAN	UIT
LBP	R290	16	20	0,3	-0,4
MBP	R290	10	25	1,7	0,7
LBP	R404A	20	25	-	-
MBP	R134a	13	18	1,5	0,1

### 13 – Dubbele drukschakelaar instelling

Koudemiddelen	Hogedrukinstellingen (bar (g))		Lagedrukinstellingen (bar (g))	
	AAN	UIT	AAN	UIT
R404A/R507/R452A	23	27	2	1
R134a/R513A	13	17	2	1

# Optyma™ Light Commercial



<b>Koneikkoja saavat asentaa ja huoltaa vain valtuutetut ammattilaiset. Noudata näitä ohjeita ja hyvää kylmäkoneiston rakentamistapaa asennuksessa, käyttöönotossa, kunnossapidossa ja huollossa.</b>
<b>Koneikkoa saa käyttää vain sille suunnitelluissa käyttökohteissa ja sallituissa käyttöolosuhteissa ja ohjeiden mukaisesti.</b>
<b>Kaikkissa olosuhteissa on noudatettava SFS-EN 378 -standardin vaatimuksia tai muita voimassa olevia paikallisia turvallisuusmääräyksiä.</b>
<b>Koneikkoa on käsiteltävä varoen, ja se on pidettävä pystysuorassa (suurin sallittu poikkeama pystyasennosta: 15°).</b>
<b>Koneikkoja voidaan käyttää kylmäaineen N = R290 kanssa, asennuksen ja huollon aikana on noudatettava varovaisuutta.</b>
<b>R290-kylmäaineita käytettäessä kaikkien jäähdytyspiirin komponenttien on oltava R290-sertifioituja. Esimerkki: Höyrystin.</b>

## Sovellettavat standardit ja direktiivit (CE ja muut kuin CE)

**EN 378 -2:** Kylmäkoneistot ja lämpöpumput – Turvallisuus- ja ympäristövaatimukset.

**EN 60335-1:** Kotitaloussähkölaitteiden ja vastaavien turvallisuus – Osa 1: Yleiset vaatimukset.

**Pienjännitedirektiivi 2014/35/EU**

**Konedirektiivi 2006/42/EU**

**Painelaitedirektiivi (PED) 2014/68/EU**

**RoHS-direktiivi 2011-65-EU**

**WEEE-direktiivi 2012-19-EU**

(Muut paikalliset sovellettavat standardit).

### 1 – Johdanto

**Nämä ohjeet koskevat Optyma™ Light Commercial -mallistoa ja kylmäjärjestelmissä käytettäviä R290 OP-LCHC, LCQC, MCGC, MCHC, MCHB, LCNC, MCNC, OP-SC, SC, PL, BD, TL, FR, NL, FF, NF, DL**

### 2 – Käsittely ja säilytys

- Pakkauksen avaamista ei suositella, ennen kuin laite on lopullisessa asennuspaikassaan.
- Säilytä ja siirrä koneikkoa pystyasennossa.
- Säilytä laitetta -35–50 °C:n lämpötilassa.
- Pakkaus ei saa altistua sateelle tai syövyttävälle olosuhteille.
- Yksikköä tulee varastoida ja kuljettaa pahvilaatikossa olevien merkintöjen mukaisesti.

### 3 – Asennus

	Älä juota, kun koneikko on paineistettuna.
	Yksikköä ei saa käyttää helposti syttyvässä ympäristössä.
	Käytä kuivainta, jossa on malliin R290 sopivat molekyyliuseulat (versioihin N0, A09, A11).
	Käytä vain kuivia ja puhtaita komponentteja ja vältä kosteuden pääsyä järjestelmään.
	Älä nosta tai siirrä koneikkoa kupariputkista kiinni pitäen. Käytä mukana toimitettua kiskoa tai pohjalevyä.

Varmista, että lauhduttimen kennon ympärillä on riittävästi tilaa, jotta varmistetaan hyvä ilmankierto.

Koneikko on asennettava eroon liikkuvista osista, mahdollisesta syttymislähteestä ja korkeasta lämpötilasta.

Yksikön ympäristön lämpötila ei saa nousta yli 50 °C:een seisontajakson aikana.

Varmista, että virtalähde vastaa yksikön vaatimuksia (katso yksikön tyyppikilpi).

Käytä puhtaita ja täysin kuivia kylmäaineluokan

kupariputkia ja hopeaseosta kovajuotoksiin. Kompressoriin kytketyn imuputkiston on joustettava kolmeen eri suuntaan tärinän vaimentamiseksi. Putkistossa tulee ottaa huomioon öljyn palautuminen kompressorille ja nesteiskujen välttäminen.

Asentajan on tehtävä riskiarviointi herkästi syttyvien kylmäaineiden (R290) käyttökohteisiin perehtymällä EN 378 -standardiin ja vastaaviin eurooppalaisiin standardeihin.

Vain pätevät ammattilaiset saavat asentaa laitteita sekä huolehtia niiden kunnossapidosta ja käyttöönotosta!

Kaikki liitännät, kuten juotokset ja laippaliitokset saa tehdä vain ammattilainen.

Estä asiattomien pääsy ympäristöön.

Kiinnitä huomiota riittävään tuuletukseen.

Poista mahdolliset kuljetusturvalliset.

Asenna koneikko vaakasuoraan.

Käytä oikeita putkikokoja.

Estä tärinä. Vältä tupakointia ja avotulta.

Kylmäaine on poistettava ja hävitettävä ammattilaisen toimesta.

#### **Koneikkojen kokoaminen**

Valmistele höyrystimestä lähtevät putkien liitännät.

On suositeltavaa käyttää kuivainta, jossa on huokoskoon 3 Å molekyyliuseulat, esim. Danfossin DML-tyyppiä.

Käytä vain kuivia komponentteja ja vältä kosteuden pääsyä järjestelmään.

Järjestelmän komponentit eivät saa sisältää klooria, mineraaliöljyä eivätkä muita rasvaisia aineita.

Suurin testauspaine saa olla enintään 32 bar.

### 4 – Kylmäaineen täyttäminen

#### **Kylmäaineen täyttäminen (N0, N1, N2, T0, T1, T2, A00, A01 ja A04)**

Liite C Kuva 2 Alla olevat prosessin kuvaukset koskevat kuvassa näkyvää laitetta.

1. Imupuolen sulkuventtiili
2. Painepuolen sulkuventtiili
3. Liitäntä imupuolelle
4. Sulkuventtiili tyhjöpumppuun
5. Sulkuventtiili täyttösynterieriin

6. Liitäntä painepuolelle

7. Sulkuventtiili painepuolelle

8. Sulkuventtiili imupuolelle

9. Liitäntä tyhjöpumppuun

10. Liitäntä täyttösynterieriin

Kun on saavutettu enintään 0,5 mbar:n tyhjä, katkaise yhteys tyhjöpumppuun sulkemalla kaikki putkiston venttiilit.

Toista tyhjennysprosessi tarvittaessa kerran tai kahdesti, ja sulje sitten kaikki putkiston venttiilit. Sulje imupuolen sulkuventtiilin huoltoliitin (1) kääntämällä kara vastapäivään takarajoitinkohtaan.

Kylmäaine täyttö on tehtävä laitteesta, joka ei ole klooria sisältävien kylmäaineiden liikaama. Yksiköissä, joissa on sulkuventtiilejä, sääntönä on, että kylmäaine tulisi aina lisätä nestemäisessä muodossa yksikön painepuolen sulkuventtiiliin läpi nesteiskujen välttämiseksi yksikköä käynnistettäessä. Jos tätä sääntöä ei voida noudattaa, kompressoria ei saa käynnistää, ennen kuin jäähdytysjärjestelmän paine ja lämpötila on tasaantunut.

Avaa jakotukin venttiilit (5) ja (7) pitäen muut venttiilit suljettuina. Kun kaikki neste on siirretty yksikön painepuolelle, sulje paineventtiilin huoltoliitin (2) kääntämällä kara vastapäivään takarajoitinkohtaan. Irrota kaikki letkuliitännät. Kiinnitä liitosmutterit sokkotulppineen painemittarin liittimiin (1) ja (2). Aseta ja kiristä tulpat venttiilien karoihin.

### 5 – Tyhjiöinti

#### **Tyhjiöinti (N2, T2, A01 ja A04)**

Liite C Kuva 2. Alla olevat prosessin kuvaukset koskevat kuvassa näkyvää laitetta.

1. Imupuolen sulkuventtiili
2. Painepuolen sulkuventtiili
3. Liitäntä imupuolelle
4. Sulkuventtiili tyhjöpumppuun
5. Sulkuventtiili täyttösynterieriin
6. Liitäntä painepuolelle
7. Sulkuventtiili painepuolelle
8. Sulkuventtiili imupuolelle
9. Liitäntä tyhjöpumppuun

## Ohjeet

10. Liitäntä täyttösylinteriin  
Liitä paineputki yksikön imupuolen sulkuventtiiliin (1).

Liitä imuputki suodatinkuivaimen kautta painepuolen sulkuventtiiliin (2).  
Tee liitäntä (3) putkiston ja imupuolen sulkuventtiilin huoltoliittimen (1) välille.  
Tee liitäntä (6) putkiston ja painepuolen sulkuventtiilin huoltoliittimen (2) välille.  
Tee liitäntä (9) tyhjöpumpun sekä putkiston (4) välille.  
Tee liitäntä (10) täyttösylinterin sekä putkiston (5) välille.  
Irrtoa molempien sulkuventtiilien (1) ja (2) karojen suojatulpat.  
Avaa venttiilit (4), (7) ja (8). Avaa sulkuventtiilit (1) ja (2) keskiasentoon. Käynnistä tyhjöpumppu.  
Tyhjöpumppuja, joita normaalisti käytetään klooria sisältäville kylmäaineille, ei voida käyttää R134a:n, R404A:n/R507:n eikä R452A:n kanssa.  
Ainoastaan tyhjöpumppua, jossa käytetään erityistä polyoliesteriöljyä, saa käyttää järjestelmiin, joiden kylmäaine sisältää FCKW:tä, HFCKW:tä ja HFKW:tä.  
(Ota yhteyttä pumpun toimittajaan.)  
**Tyhjiöinti (T0, A00)**  
Tyhjiöinti tapahtuu kompressorin ja sitten prosessiliittimen kautta, kun liitäntä jäähdytyspiiriin on valmis.  
Varaa riittävästi aikaa tyhjiöintiin, koska se tehdään ainoastaan matalapainepuolelta, ellei tyhjiöinnin nopeuttamiseksi ole tehty lisätoimia.  
Tyhjöpumppuja, joita normaalisti käytetään klooria sisältäville kylmäaineille, ei saa käyttää R134a:n eikä R404A:n/R507:n kanssa.  
Ainoastaan tyhjöpumppua, jossa käytetään erityistä polyoliesteriöljyä, saa käyttää järjestelmiin, joiden kylmäaine sisältää FCKW:tä, HFCKW:tä ja HFKW:tä. (Ota yhteyttä pumpun toimittajaan.)

## 6 – Sähköliitännät

- Valmistele sähköliitännät, kun tyhjiöinti on käynnissä. Älä käynnistä kompressoria, ennen kuin tyhjö on rikottu. Poista suojus liitinrasian päältä. Liitä johtimet.
- Yksikköä on mahdotonta käynnistä liittämättä termostaattia (1H, katso Liite C, kuva 2), tai ilman että yhteys kohtien 1 tai 2 ja L:n välillä on muodostettu (Liite C Kuva 3-16).

**Liite C Kuva 3.** KytKentäkaavio kompressorisarjoille P, T, N, F, S.

**Liite C Kuva 4.** KytKentäkaavio kompressorisarjoille: SC, jossa CSR (käynnistys- ja käyttökondensaattori).

**Liite C Kuva 5.** KytKentäkaavio kompressorisarjoille: TL-, FR- ja SC-koneikot, joissa on painekeytkin.

**Liite C Kuva 6.** KytKentäkaavio kompressorisarjoille: SC-koneikot, joissa on yhdistetty suur- ja matalapainekeytkin sekä CSR (käynnistys- ja käyttökondensaattori).

**Liite C Kuva 7.** KytKentäkaavio kompressorisarjoille: MP- ja ML-koneikot.

**Liite C Kuva 8.** Kaksoiskompressorin kytKentäkaavio, katso SC.

**Liite C Kuva 9.** Kaksoiskompressorin kytKentäkaavio, puhaltimen nopeus 50 %.

**Liite C Kuva 10-16.** R290-mallien kytKentäkaavio.

1A. Pääkäämi

1B. Käynnistyskäämi

1C. Käynnistysrele  
1D. Käämin suojus  
1E. Käynnistyskondensaattori  
1F. Vuotovastus  
1G. Käyntikondensaattori  
1H. Termostaatti  
1J. Puhallin  
1K. Painekeytkin

**Asenna liitinrasian suojus**

Pidä herkästi syttyvät aineet poissa sähkölaitteiden läheisyydestä.

## 7 – Vaatimustenmukaisuustodistus

- Kaikki koneikkomme ovat pienjännitedirektiivin 2014/35/EU vaatimusten mukaisia, ja ne on integroitava asennuksen yhteydessä.
- **Pienjännitedirektiivi 2014/35/EU**  
EN 60335-1:2012 + A11:2014 - Kotitaloussähkölaitteiden ja vastaavien turvallisuus - Osa 1: Yleiset vaatimukset – kaikille edellä mainituille koneikoille, joissa on kompressorialustat FR, GS, L, P, NF, NL, PL, SC ja TL.
- **Ekologisesta suunnittelusta annettu direktiivi 2009/125/EY**, joka asettaa puitteet energiaan liittyvien tuotteiden ekologiselle suunnittelulle asetettaville vaatimuksille.
- Ammattikäyttöön tarkoitettuja kylmä- ja pakastekaappeja, pikajäähdetykskaappeja, koneikkoja ja prosessijäähdetyslaitteita koskeva **ASETUS (EU) 2015/1095**, jolla pannaan täytäntöön ekosuunnitteludirektiivi 2009/125/EY.
- Koneikkojen mittaukset on tehty standardin EN 13771-2:2007 mukaisesti – Kompressorit ja koneikot jäähdystehon testaus ja testimenetelmät - Osa 2: Koneikot
- Seuraavat hyväksynnät on hankittava valtuutettujen laitosten kautta, joita ovat esim. Nemko, Demko BEAB ja LCJE.  
Muun muassa EN 60 335-2-24, IEC 335-2-89, IEC 79-15.

## 8 – Turvallisuus

**Tärkeitä huolto- ja turvallisuusvinkkejä**

Kuivain on aina vaihdettava, kun järjestelmä on avattu.

Puhalla järjestelmää kuivalla tyypellä ennen juottamista.

Kun viallinen järjestelmä tyhjenetään, kylmäaine on kerättävä sekoittamatta sitä muihin kylmäaineisiin, eikä kylmäainetta saa vuotaa ympäristöön.

(Katso myös "Asennus").

Lauhdutin ja koko koneikko on puhdistettava säännöllisin väliajoin.

Määritettyjä huolto- ja puhdistusvälejä on noudatettava.

Paineenalaisen komponenttien parissa työskentely on vaarallista.

Varo kuumia ja erittäin kylmiä osia.

Varo liikkuvia osia (esim. puhallinta).

Kiinnitä huomiota riittävään tuuletukseen.

Varmista puhaltimen moitteeton toiminta.

Valmistajan asettamia käyttörajoituksia on noudatettava.

Jos painekeytkimet on määritetty, ne on asennettava ammattilaisen toimesta.

Käyttökuntoa on seurattava moitteettoman toiminnan varmistamiseksi.

Tarkista, ovatko sulkuventtiilit

(imu- ja painepuolella) kokonaan auki.

Varmista, että EN 378 -standardia noudatetaan. Jos koneellinen ilmanvaihto on tarpeen, se on osoitettava selvästi (esim. etiketillä). Älä asenna syövyttävään, kosteaan tai pölyiseen ympäristöön.

Älä asenna tai käynnistä tiloissa, joissa esiintyy herkästi syttyviä kaasuja tai kokoonpanoja, joissa käytetään sellaisia.

**Painelaitedirektiivi 2014/68/EU****EN 378-2:2016**

Koneikot eivät ole painelaitedirektiivissä tarkoitettuja painelaitteita.

Yksikön/kokoonpanon, johon koneikko asennetaan/integroidaan, on täytettävä painelaitedirektiivin vaatimukset.

## 9 – Kylmäaineen maksimitäytöt

On suositeltavaa lisätä kylmäaineita ainoastaan sopiva määrä, joka tarvitaan jäähdytysjärjestelmän asianmukaiseen toimintaan.

Kapillaariputkella varustetuissa jäähdytysjärjestelmissä täytös on mukautettava järjestelmään sopivaksi.

Käyttöä varten tehtävä täyttö ei saa koskaan ylittää lauhduttimen ja varaajan tilavuutta.

Vältä aina liiallista kylmäainetäyttöä!

**Kampikammion lämmitin**

Jos kylmäaineen maksimimäärä ei voi tarkkailla T0-, T2-, A01-, A02-, A04- tai T0-koneikoissa, on käytettävä kampikammion lämmitysvastusta tai "pump-down menetelmää". Kampikammion lämmitysvastus on asennettava suoraan hitsisauman päälle.

Kampikammion lämmitysvastus lämmittää kompressorin öljyä seisokkiaikoina.

Jos jäähdytysjärjestelmä on ollut poissa käytöstä pidempiä aikoja, kampikammion lämmitysvastus on kytkettävä päälle 2-3 tuntia ennen käynnistystä. Seuraavia kampikammion lämmitysvastuksia suositellaan

TL ja FR: 35 W (koodinro 192H2095)

SC: 55 W (koodinro 192H2096)

## 10 – Kylmäkäynnistys

Yksikön asennuksen jälkeen on odotettava, että kompressorit saavuttaa yli 10 °C:n lämpötilan, ennen kuin se käynnistetään ensimmäisen kerran. Näin vältetään öljyn liian suuresta viskositeetista johtuvat käynnistysongelmat. Matalammassa lämpötiloissa voi olla odotettavissa käämin suojuksen laukeamisia, kunnes öljyn viskositeetti laskee. Katso myös "kampikammion lämmitysvastus". Älä koskaan käynnistä alipaineisena!

## 11 – Käämin suojus

Kompressoreissa on sisäänrakennettu käämin suojus. Jos suojus kytketty päältä kompressorin ollessa kylmä, suojuksen uudelleenkytkettyminen voi kestää noin 5 minuuttia.

Jos käämin suojus kytketty päältä kompressorin ollessa kuuma (kompressorin kotelon lämpötila yli 80 °C), suojuksen uudelleenkytkettyminen voi kestää jopa 45 minuuttia.

**Käämin suojuksen tarkistaminen**

Jos kompressoriin tulee vika, se on tarkistettava mittaamalla vastus suoraan virran sisäänviennistä, jotta nähdään, johtuuko vika moottoriviasta vai yksinkertaisesti käämin suojuksen laukeamisesta.



## Ohjeet

Liite C Kuva 3. Käämin suojuksen sijainti virtapiirissä.

1A. Pääkäämi

1B. Käynnistyskäämi

1D. Käämisuoja

Jos vastuksen mittauksessa käy ilmi, että moottorin käämien kautta sisäänviennin kohdista K ja S on olemassa yhteys mutta

pisteiden K ja F tai S ja F välinen piiri on katkennut, tämä osoittaa, että käämisuoja on lauennut. Odota silloin suojan nollautumista.

### 12 – ACB-pessostaattiasetus (mini HP/LP)

Käyttökohde	Kylmäaine	Suurpaineasetus (baaria)		Matalapaineasetus (baaria)	
		ON	OFF	ON	OFF
LBP	R290	16	20	0,3	-0,4
MBP	R290	10	25	1,7	0,7
LBP	R404A	20	25	-	-
MBP	R134a	13	18	1,5	0,1

### 13 – Kaksoispainekeytkimen asetus

Kylmäaineet	Korkeapaineasetukset (baaria (g))		Matalapaineasetukset (baaria (g))	
	ON	OFF	ON	OFF
R404A/R507/R452A	23	27	2	1
R134a/R513A	13	17	2	1

بشكل احترافي.  
يجب مراقبة حالة التشغيل لضمان التشغيل المثالي.  
تحقق ما إذا كانت صمامات الإغلاق (جانبى الشفط والنفث) مفتوحة تمامًا.  
تأكد من مراعاة المعيار EN 378.  
إذا كانت التهوية الإجبارية ضرورية، يجب توضيح ذلك تمامًا (على سبيل المثال بواسطة ملصق).  
لا تقم بتثبيت الجهاز في بيئة عدوانية أو رطبة أو متربة.  
لا تقم بتثبيت الجهاز أو بدء تشغيله في غرف تحتوي على غازات قابلة للاشتعال أو في منشآت تعمل بهذه الغازات.  
**توجيه معدات الضغط 2016/2014/68 EU EN 378-2:**  
وحدات التكييف لا تعتبر "وحدات" وفقًا لتوجيه PED.  
يجب أن تكون الوحدة / التثبيت الذي يتم به تثبيت / دمج وحدة التكييف متوافقة مع توجيه PED.

9 - الحد الأقصى لنفقات مادة التبريد  
يوصى بإضافة الكمية الصحيحة فقط من مواد التبريد الضرورية لكي يعمل نظام التبريد بالشكل الصحيح. بالنسبة لأنظمة التبريد ذات الأنابيب الشعرية، يجب تكيف الشحن ليتناسب مع كل نوع من أنواع الأنظمة. يجب ألا تتجاوز شحنة التشغيل أبدًا سعة المكثف والمستقبل.  
جنب دائمًا الشحن الزائد لمادة التبريد!  
**سخان علبة المرافق**  
إذا تعذرت ملاحظة الكميات القصوى من مادة التبريد في وحدات التكييف T0 أو T2 أو A01 أو A02 أو A04 أو T0 على التوالي، يجب استخدام سخان علبة المرافق أو ناقل حركة خضض الضغط. يجب تركيب سخان علبة المرافق مباشرة فوق اللحام.  
يقوم سخان علبة المرافق بتسخين زيت الضاغطة أثناء فترات التوقف. عندما يكون نظام التبريد في وضع السكون لفترات أطول، يجب قطع تشغيل سخان علبة المرافق في غضون ساعتين إلى 3 ساعات قبل بدء تشغيله. يوصى باستخدام سخانات علبة المرافق التالية  
FR: 35 W و TL (رقم الكود 192H2095)  
SC: 55W (رقم الكود 192H2096)

10 - بدء التشغيل على البارد  
بعد تثبيت الوحدة، يجب السماح للضاغط بالوصول إلى درجة حرارة أعلى من 10 درجات مئوية قبل بدء تشغيله لأول مرة. سيؤدي ذلك إلى منع مشاكل بدء التشغيل المحتملة الناتجة عن لزوجة الزيت العالية جدًا.  
في درجات الحرارة المنخفضة، قد يكون من المتوقع حدوث بعض التعثر لواقى الملف اللولبي حتى تنخفض لزوجة الزيت.  
انظر أيضًا سخان علبة المرافق.  
لا تبدأ أبدًا أثناء التفريغ!

11 - واقى الملف اللولبي  
تحتوي الضواغط على واقى مدمج للملف اللولبي. إذا توقف الواقى بينما يكون الضاغط باردًا، فقد يستغرق الأمر تقريبًا 5 دقائق لإعادة ضبط الواقى.  
إذا توقف واقى الملف اللولبي بينما يكون الضاغط ساخنًا (درجة حرارة مثبت للضاغط أعلى من 80 درجة مئوية)، فقد يمر ما يصل إلى 45 دقيقة قبل أن تتم إعادة ضبط الواقى.  
**فحص واقى الملف اللولبي**  
في حالة حدوث عطل في الضاغط، يجب إجراء فحص من خلال قياس المقاومة مباشرةً على الوصلة الداخلة الحالية لمعرفة ما إذا كان العطل ناجمًا عن تلف في المحرك أو مجرد عطل في واقى الملف اللولبي.  
الملحق "ج" الشكل 3، موقع واقى الملف اللولبي في الدائرة الكهربائية.

للضاغط المزود، انظر SC.  
**الملحق "ج" الشكل 9:** مخطط الأسلاك للضاغط المزود، مع 750 من سرعة المروحة.  
**الملحق "ج" الشكل 10-16:** مخطط الأسلاك لطرزات R290.  
1.أ. الملف اللولبي الرئيسي  
1.ب. بدء الملف اللولبي  
1.ج. بدء المرحلة  
1.د. واقى الملف اللولبي  
1.هـ. بدء المكثف  
1.و. مقاومة صمام الصرف  
1.ز. مكثف التشغيل  
1.ح. منظم الحرارة  
1.ي. المروحة  
1.ك. عنصر التحكم في الضغط  
**قم بتركيب غطاء لوحة الأطراف.**  
ابعد المواد القابلة للاشتعال عن المعدات الكهربائية.

7- إعلان المطابقة  
• جميع وحدات التكييف الخاصة بنا متوافقة مع توجيه الجهد المنخفض EU/2014/35 ويجب دمجها أثناء التثبيت.  
• **توجيه الجهد المنخفض EU/2014/35**  
EN 60335-1:2012 + A11:2014- الأجهزة المنزلية والأجهزة الكهربائية المماثلة - الأمان - الجزء 1:  
المتطلبات العامة - لجميع وحدات التكييف المذكورة أعلاه مع منصات الضاغط FR و GS و L و P و NF و NL و PL و SC و TL.  
• **توجيه التصميم البيئي EC/2009/125:** إنشاء إطار عمل لتحديد متطلبات التصميم البيئي للمنتجات المتعلقة بالطاقة.  
• **لائحة الاتحاد الأوروبي (2015/1095):** التي تنفذ توجيه التصميم البيئي EC/2009/125 فيما يتعلق بمتطلبات التصميم البيئي خزائن التخزين المبردة الاحترافية المهنية، وخزانات الصقل، ووحدات التكييف، ومبرد المعالجة.  
• يتم إجراء قياسات وحدة التكييف وفقًا للمعيار EN 13771-2:2007 - وحدات الضاغط والتكييف لاختبار أداء التبريد وطرق الاختبار - الجزء 2: وحدات التكييف  
• يجب الحصول على الموافقات التالية من خلال المعاهد المعتمدة مثل Nemko و Demko و BEAB و LCJE. وما إلى ذلك. المعيار EN 60 335-2-24 والمعيار IEC 335-2-89 والمعيار IEC 79-15، وغيرها.

8 - السلامة  
**نصائح مهمة للخدمة والسلامة**  
يجب دائمًا استبدال الجفء عند فتح النظام.  
قم بالدق عبر النظام باستخدام النيتروجين الجاف قبل اللحام.  
عند إفراغ نظام معيب، يجب جمع مادة التبريد دون خلطها مع مواد التبريد الأخرى، ويجب ألا تنسرب مادة التبريد إلى البيئة.  
(انظر أيضًا "التثبيت").  
يجب تنظيف المكثف ووحدة التكييف الكاملة بانتظام. يجب مراعاة فترات الصيانة والتنظيف المحددة.  
إن العمل على المكونات التي تتعرض للضغط أمر يتسم بالخطورة.  
احذر من المكونات الساخنة والباردة للغاية. احذر من المكونات المتحركة (مثل المروحة).  
انتبه للتهوية الكافية.  
تحقق من التشغيل المثالي للمروحة.  
يجب مراعاة حدود التطبيق المنصوص عليها من قبل الشركة المصنعة.  
إذا تم خديد عناصر التحكم في الضغط، يجب تركيبها

4. صمام الإغلاق للمضخة الفراغية  
5. صمام الإغلاق لأسطوانة الشحن  
6. التوصيل بجانب التفريغ  
7. صمام الإغلاق بجانب التفريغ  
8. صمام الإغلاق بجانب الشفط  
9. التوصيل بالمضخة الفراغية  
10. التوصيل بأسطوانة الشحن  
قم بتوصيل خط التفريغ بصمام الشفط (1) الخاص بالوحدة.

قم بتوصيل خط الشفط عبر مجفف المرشح. بصمام إيقاف التفريغ (2).  
قم بعمل التوصيلة (3) بين المشعب وموصل الخدمة لصمام إيقاف الشفط (1).  
قم بعمل التوصيلة (6) بين المشعب وموصل الخدمة لصمام إيقاف التفريغ (2).  
قم بعمل الوصلة (9) بين المضخة الفراغية والمشعب (4).  
قم بعمل الوصلة (10) بين أسطوانة الشحن والمشعب (5).

قم بإزالة الأغشية الواقية من مغازل صمامات الإيقاف (1) و(2).  
افتح صمامات (4) و(7) و(8). افتح صمامتي الإيقاف (1) و(2) إلى الوضع الأوسط. ابدأ تشغيل مضخة التفريغ. لا يمكن استخدام مضخات التفريغ التي تُستخدم عادةً في مواد التبريد المحتوية على الكلور، مع R134a و R404A و R507 / R452A.  
يمكن استخدام مضخة تفريغ مع زيت Polyolester خاص فقط للأنظمة التي تحتوي على مادة تبريد تحتوي على FCKW و HFCKW و HFKW.  
(اتصل بمورد المضخة.)

**الإخلاء (A00، T0)**  
يتم الإخلاء من خلال الضاغط ثم معالجة الموصل بعد إكمال التوصيل في دائرة التبريد.  
خطط لوقت كافٍ للإخلاء حيث أنه يتم من جانب الضغط المنخفض فقط. ما لم يتم اتخاذ تدابير إضافية لتسريع عملية الإخلاء.  
يجب عدم استخدام مضخات التفريغ المستخدمة عادةً في مواد التبريد المحتوية على الكلور مع R134a و R404A و R507. يمكن استخدام مضخة تفريغ مع زيت Polyolester خاص فقط للأنظمة التي تحتوي على مادة تبريد تحتوي على FCKW و HFCKW و HFKW.  
(اتصل بمورد المضخة.)

6- التوصيلات الكهربائية  
- جهاز التوصيلات الكهربائية أثناء تنفيذ عملية الإخلاء. لا تقم بتشغيل الضاغط حتى يتم فتح الإغلاق الفراغي. قم بإزالة الغطاء الموجود على اللوحة الطرفية، قم بربط أطراف التوصيل.  
- من المستحيل بدء توصيل تشغيل الوحدة بدون منظم حرارة (1H). انظر الملحق "ج"، الشكل (2) أو بدون عمل وصلة بين 1 و 2، على التوالي، و (الملحق "ج" الشكل (3-16).  
**الملحق "ج" الشكل 3:** مخطط توصيل الأسلاك لمنصة الضاغط: P, T, N, F, S.  
**الملحق "ج" الشكل 4:** مخطط توصيل الأسلاك لمنصة الضاغط: SC مع CSR (بدء وتشغيل المكثف).  
**الملحق "ج" الشكل 5:** مخطط توصيل الأسلاك لمنصة الضاغط: وحدات التكييف FR و TL و SC مع التحكم في الضغط.  
**الملحق "ج" الشكل 6:** مخطط توصيل الأسلاك لمنصة الضاغط: وحدات تكثيف SC مع التحكم المجمع في الضغط العالي والمنخفض و CSR (بدء وتشغيل المكثف).  
**الملحق "ج" الشكل 7:** مخطط توصيل الأسلاك لمنصة الضاغط: وحدات تكثيف MP & ML.  
**الملحق "ج" الشكل 8:** مخطط توصيل الأسلاك

# Optyma™ Light Commercial



تركيب وصيانة وحدات التكييف بواسطة الموظفين المؤهلين فقط. اتبع هذه التعليمات والممارسات السليمة لهندسة التبريد فيما يتعلق بالتركيب والتشغيل والصيانة والخدمة.
يجب استخدام وحدة التكييف فقط للغرض (الأغراض) المصممة له وضمن نطاق تطبيقها ووفقاً للتعليمات.
في جميع الظروف، يجب استيفاء متطلبات المعيار EN378 (أو غيرها من لوائح السلامة المحلية المعمول بها).
يجب التعامل مع وحدة التكييف بحذر في الوضع الرأسي (أقصى إزاحة من الوضع الرأسي: 15 درجة)
يمكن استخدام وحدات التكييف التي تحتوي على حرف غاز التبريد R290، مع الحرص اللازم أثناء التركيب والخدمة.
في حالة مواد التبريد R290، يجب أن تكون جميع المكونات الموجودة في دائرة التبريد معتمدة وفقاً لمعيار R290. مثال: المبخر.

المعايير والتوجيهات ذات الصلة (CE وغير CE)  
 2- EN 378: أنظمة التبريد والمضخات الحرارية - متطلبات السلامة والبيئة.  
 1- EN 60335: الأجهزة الكهربائية المنزلية وما يشابهها - السلامة - الجزء الأول: المتطلبات العامة  
 توجيه الجهد المنخفض رقم 2014 / 35 / UE  
 توجيه الآلات رقم 2006 / 42 / CE  
 توجيه الضغط الخاص بالمفوضية الأوروبية (PED) رقم 2014/68/EU  
 توجيه الحد من النفايات الخطرة (RoHS) 2011-65-EU  
 توجيه نفايات المعدات الكهربائية والإلكترونية 2012-19-EU (المعايير المحلية الأخرى القابلة للتطبيق)

## 1 - المقدمة

تتعلق هذه التعليمات بمجموعة Optyma™  
 R290 OP-LCHC، و Light Commercial  
 LCQC, MCGC, MCHC, MCHB, LCNC, MCNC, OP-  
 SC, SC, PL, BD, TL, FR, NL, FF, NF, DL  
 المستخدمة في  
 أنظمة التبريد

## 2 - المناولة والتخزين

- يوصى بعدم فتح العبوة قبل أن تكون الوحدة في المكان النهائي المخصص لتثبيتها.
- قم بتخزين ونقل الوحدة وهي في وضع رأسي.
- قم بتخزين الوحدة في درجة حرارة بين 35- درجة مئوية و 50 درجة مئوية.
- لا تعرض العبوة للمطر أو الأجواء المسببة للتآكل.
- يجب أن يكون تخزين الوحدة ونقلها مطابقاً للعلامة الموجودة على صندوق الكرتون الخاص بها.

## 3 - التثبيت

لا تقم بالصقل طالما أن وحدة التكييف تحت الضغط.	
لا يجوز تشغيل الوحدة في جو قابل للاشتعال.	
استخدم مجففاً بمناخل تصفية جزئية مناسبة لـ R290 (للإصدارات A09, A11, N0).	
لا تستخدم إلا المكونات الجافة والنظيفة مع تجنب دخول الرطوبة إلى النظام.	
لا ترفع أو تحرك وحدة التكييف باستخدام أنابيب نحاسية. استخدم القضيب أو القاعدة المرفقة	

## 4 - شحن مادة التبريد

شحن مواد التبريد (N0، و N1، و N2، و T0، و T1، و T2، و A00، و A01، و A04)

الملحق "ج" الشكل 2. أوصاف العملية الواردة أدناه تستند إلى المعدات الموضحة.

1. صمام إيقاف الشفط
2. صمام إيقاف التفريغ
3. التوصيل بجانب الشفط

## 5 - الإخلاء

الإخلاء (N2 و T2 و A01 و A04)

الملحق "ج" الشكل 2. أوصاف العملية الواردة أدناه تستند إلى المعدات الموضحة.

1. صمام إيقاف الشفط
2. صمام إيقاف التفريغ
3. التوصيل بجانب الشفط

تأكد من وجود مسافة كافية بين ملف المكثف والمناطق المحيطة به لضمان دوران الهواء بشكل جيد.  
 يجب تركيب وحدة التكييف بعيداً عن المكونات المتحركة والمصادر المحتملة اشتعالها ودرجة الحرارة المرتفعة.  
 يجب ألا تزيد درجة الحرارة المحيطة للوحدة عن 50 درجة مئوية أثناء توقف دورة العمل.  
 تأكد من أن مصدر الطاقة يتوافق مع خصائص الوحدة

## التعليمات

واقى الملف اللولبي قد توقف عن العمل. ولذلك، انتظر حتى تتم إعادة تعيين الواقي.

الحالية، مع وجود انقطاع في الدائرة بين النقطتين K و F أو بين النقطتين S و F، فهذا يشير إلى أن

أ. الملف اللولبي الرئيسي

ب. بدء الملف اللولبي

د. واقى الملف اللولبي

إذا أظهر قياس المقاومة أن هناك اتصالاً عبر الملفات اللولبية للمحرك من النقطتين K و S لوصلة الإدخال

### 12 - إعداد ACB Pressostat (mini HP/LP)

إعدادات الضغط المنخفض (بالبار)		إعدادات الضغط العالي (بالبار)		مادة التبريد	الاستخدام
إيقاف تشغيل	تشغيل	إيقاف تشغيل	تشغيل		
-0.4	0.3	20	16	R290	LBP
0.7	1.7	25	10	R290	MBP
-	-	25	20	R404A	LBP
0.1	1.5	18	13	R134a	MBP

### 13 - ضبط مفتاح الضغط المزدوج

إعدادات الضغط المنخفض (بالبار (g))		إعدادات الضغط العالي (بالبار (g))		مواد التبريد
إيقاف تشغيل	تشغيل	إيقاف تشغيل	تشغيل	
1	2	27	23	R404A/R507/R452A
1	2	17	13	R134a/R513A

## Instructions

### Annex - A, Technical data

#### Label information

<b>B</b>	<b>Optyma™</b> by Danfoss	EAN No :			<b>A</b>
	<b>Serial No 29XXXXXXX</b>			MADE IN ITALY	
<b>C</b>	Refrigerant: (1) Rxxxx (2)	<b>114X1219</b>	<b>Model: XXXXXXXX</b>		<b>D</b>
	Max. Working Pressure HP (1) xx	Comp: xxx- xxxV xxHz Fan: xxx- xxxV xxHz- xxHz Refr. Charge < 150g			<b>E</b>
	According with EN 378 and temperature 46°C	If imported from UK - Danfoss Ltd., 22 Wycombe End, HP9 1NB, GB Імпортер: ТОВ з іі "Данфосс ТОВ" 04080, Київ 80, п/с 168, Україна			

- A:** Condensing unit code number
- B:** Production serial number
- C:** Refrigerant
- D:** Model designation
- E:** Power supply for compressor & fan motor

### Designation - Catalogue

**OP - LCQN 048 MT A00 E**

OP = Optyma

1 2 3 4 5 6 7 8

1	<b>Application:</b> M = Medium Back Pressure ; L = Low Back Pressure
2	<b>Compressor Platform:</b> C: Air cooled condensing unit with single fan
3	<b>Refrigerant:</b> G: R134a, R513A; H: R404A/R507; Q: R452A, R404A/R507; N: R290
4	<b>Condenser design:</b> C: Fin & Tube condenser, ambient temperature up to 43°C
5	<b>Compressor displacement:</b> Example 048 = 48 cm <sup>3</sup>
6	<b>Reciprocating compressor platform:</b> FR = FR, NF = NF, SC = SC, GS = GS, NX = NX, NB = NBC, NS = NS, NU = NUY, NP = NPT, MP = MPT, MY = MLY, MX = MX, TL = TL, NL = NL
7	<b>Version:</b> A00, A01, A04, A09, A10, A11. See table Feature overview, for features within each version.
8	<b>Electrical code:</b> G: Compressor 230V/1P/50Hz, fan 230V/1P/50Hz E: Compressor 400V/3P/50Hz, fan 230V/1P/50Hz

	Light Commercial			Light Commercial R290		
	A00	A01	A04	A09	A10	A11
Ambient temperature	Up to 43°C			Up to 43°C		
Hermetic reciprocating compressor platform	MPT, MLY, NL, SC, GS, FR, TL, NF			NUY, NBC, NPT, NS, NX		
Unit base	Rails or base plate					
Condenser type	Fin & Tube (painted)					
Fan	AC/EC	AC/EC	AC/EC	EC	EC	EC
Bracket & tube for pressostat mounting	-	yes	yes	yes	-	-
Dual pressure switch - KP 17 WB	-	-	yes	-	-	-
Schrader valve	-	-	-	yes	yes	yes
Wired electrical box	yes	yes	yes	yes	yes	yes
Mini HP/LP pressostat	-	-	-	-	yes	-
Power cord	-	-	yes	-	yes	-
Receiver	-	yes	yes	-	Combo drier + receiver	-

## Instructions

### Designation - Non catalogue

#### SC 18 G X T2

T T T T T  
1 2 3 4 5

1	<b>Compressor Platform:</b> PL, TL, NL, FR, SC, GS
2	<b>Compressor displacement:</b> Example 048 = 48 cm <sup>3</sup>
3	<b>Application and Refrigerant:</b> <b>CM</b> = LBP; R22 <b>CL</b> = LBP; R404A/R507 <b>CN</b> = LBP/MBP; R290 <b>CP</b> = LBP; R404A/R507, R452A <b>DM</b> = HBP; R22 <b>DL</b> = HBP; R404A/R507 <b>F</b> = LBP/(MBP); R134a <b>FT</b> = LBP tropical; R134a <b>G</b> = LBP/MBP/HBP; R134a & R513A <b>GH</b> = Heat pump optimized; R134a <b>MF</b> = MBP; R134a <b>ML</b> = MBP; R404A/507
4	<b>Start characteristics:</b> <b>X</b> = HST <b>K</b> = LST
5	<b>Version:</b> N0 - For capillary tube - without stop valves, without receiver N1 - For capillary tube - with 1x stop valve, without receiver N2 - For capillary tube - with 2x stop valve, without receiver T0 - For expansion valve - with receiver without 2x stop valves T1 - For expansion valve - with receiver with 1x stop valves T2 - For expansion valve - with receiver with 2x stop valves

	Light Commercial					
	N0	N1	N2	T0	T1	T2
Ambient temperature	Up to 43°C					
Hermetic reciprocating compressor	NL, SC, GS, FR, TL, NF, DL					
Unit base	Rails or base plate					
Condenser type	Fin & Tube (painted)					
Schrader valve	-	-	-	yes	yes	yes
Wired electrical box	yes	yes	yes	yes	yes	yes
Service valve	-	yes*	yes	-	yes*	yes
Receiver	-	-	-	yes	yes	yes

\*) 1X Service valve

## Instructions

### Catalogue Models

#### Light Commercial - Technical data

Application	Version			Description	Compressor	Electrical code	Refrigerant	Condenser coil		Fan		Receiver Volume (L)	Suction Line	Liquid line
	A00	A01	A04					Designation	Internal Volume (L)	Number	Blade (mm)			
LBP	114X1208	114X1209	114X1211	OP-LCHC004TL	TL4CL	G	H	BG2	0.25	1	200	0.8	1/4"	1/4"
LBP		114X1221		OP-LCQC004ML	MLY45LAB	G	Q	BG2	0.25	1	200	0.8	3/8"	1/4"
LBP	114X1216	114X1217	114X1219	OP-LCHC006FR	FR6CL	G	H	BG2	0.25	1	200	0.8	3/8"	1/4"
LBP		114X1337		OP-LCQC006ML	MLY60LAB	G	Q	BG3	0.31	1	230	1.1	3/8"	1/4"
LBP	114X1328	114X1329	114X1331	OP-LCHC007NL	NL7CLX	G	H	BG3	0.31	1	230	1.1	3/8"	1/4"
LBP	114X1324	114X1325	114X1327	OP-LCHC008FR	FR8.5CL	G	H	BG3	0.31	1	230	1.1	3/8"	1/4"
LBP	114X1304	114X1301	114X1302	OP-LCHC008NL	NL8.4CLX	G	H	BG3	0.31	1	230	1.1	3/8"	1/4"
LBP		114X1341		OP-LCQC008ML	MLY80LAB	G	Q	BG3	0.31	1	230	1.1	3/8"	1/4"
LBP	114X1440	114X1441	114X1443	OP-LCHC012SC	SC12CL	G	H	BG4/5	0.4	1	254	1.1	3/8"	1/4"
LBP	114X1444			OP-LCHC012SC	SC12CLX.2	G	H	BG4/5	0.4	1	254	1.1	3/8"	1/4"
LBP		114X1449		OP-LCQC012ML	MLY12LAB	G	Q	BG4/5	0.4	1	254	1.1	3/8"	1/4"
LBP		114X1569		OP-LCQC012MP	MPT12LA	G	Q	BG4/5	0.4	1	254	1.1	3/8"	1/4"
LBP		114X1573		OP-LCQC014MP	MPT14LA	G	Q	BG4/5	0.4	1	254	1.1	1/2"	1/4"
LBP	114X1548	114X1549	114X1551	OP-LCHC015SC	SC15CLX	G	H	BG4/5	0.4	1	254	1.1	3/8"	1/4"
LBP	114X1556	114X1557	114X1559	OP-LCHC018SC	SC18CL	G	H	BG4/5	0.4	1	254	1.1	1/2"	1/4"
LBP	114X1600	114X1601	114X1602	OP-LCHC021SC	SC21CL	G	H	BG6	0.63	1	300	1.1	1/2"	1/4"
LBP		114X1673		OP-LCHC026GS	GS26CLX	G	H	BG6	0.63	1	300	2.4	1/2"	3/8"
LBP		114X1781	114X1783	OP-LCHC034GS	GS34CLX	G	H	BG7	0.84	1	300	2.4	1/2"	3/8"
MBP	114X0104	114X0105	114X0107	OP-MCGC003TL	TL3GX	G	G	BG1	0.13	1	172	0.8	1/4"	1/4"
MBP	114X0108	114X0109	114X0111	OP-MCGC004TL	TL4GX	G	G	BG1	0.13	1	172	0.8	1/4"	1/4"
MBP	114X0301	114X0302	114X0303	OP-MCHC004TL	TL4DL	G	H	BG3	0.31	1	230	1.1	3/8"	1/4"
MBP	114X0112	114X0113	114X0115	OP-MCGC005TL	TL5GX	G	G	BG1	0.13	1	172	0.8	1/4"	1/4"
MBP	114X0200	114X0201	114X0203	OP-MCGC006FR	FR6GX	G	G	BG2	0.25	1	200	0.8	3/8"	1/4"
MBP	114X2316	114X2317	114X2319	OP-MCHC006FR	FR6DLX	G	H	BG3	0.31	1	230	1.1	3/8"	1/4"
MBP	114X0228			OP-MCGC006NL	NL6.1MF	G	G	BG2	0.25	1	200	0.8	3/8"	1/4"
MBP	114X0216	114X0217	114X0219	OP-MCGC007FR	FR7.5GX	G	G	BG2	0.25	1	200	0.8	3/8"	1/4"
MBP	114X0244			OP-MCGC007NL	NL7.3MF	G	G	BG2	0.25	1	200	0.8	3/8"	1/4"
MBP	114X2424	114X2425	114X2427	OP-MCHB007NF	NF7MLX	G	H	BG4/5	0.4	1	254	1.1	3/8"	1/4"
MBP	114X0224	114X0225	114X0227	OP-MCGC008FR	FR8.5GX	G	G	BG2	0.25	1	200	0.8	3/8"	1/4"
MBP	114X0204	114X0205		OP-MCGC008NL	NL8.4MF	G	G	BG2	0.25	1	200	0.8	3/8"	1/4"
MBP	114X0352			OP-MCGC008NL	NL8.4MF	G	G	BG3	0.31	1	230	-	3/8"	1/4"
MBP			114X0223	OP-MCGC010SC	SC10GX	G	G	BG2	0.25	1	200	0.8	3/8"	1/4"
MBP	114X0403	114X0404	114X0405	OP-MCHC010SC	SC10MLX	G	H	BG4/5	0.4	1	254	1.1	3/8"	1/4"
MBP	114X0336	114X0337	114X0339	OP-MCGC011FR	FR11GX	G	G	BG3	0.31	1	230	1.1	3/8"	1/4"
MBP	114X0340	114X0341	114X0343	OP-MCGC012SC	SC12GX	G	G	BG3	0.31	1	230	1.1	3/8"	1/4"
MBP	114X0406	114X0407	114X0408	OP-MCHC013SC	SC12MLX	G	H	BG4/5	0.4	1	254	1.1	3/8"	1/4"
MBP	114X0448	114X0449	114X0451	OP-MCGC015SC	SC15GX	G	G	BG4/5	0.4	1	254	1.1	3/8"	1/4"
MBP		114X2649	114X2651	OP-MCHC015SC	SC15MLX	G	H	BG6	1.1	1	300	1.1	1/2"	1/4"
MBP	114X0556	114X0557	114X0559	OP-MCGC018SC	SC18G	G	G	BG4/5	0.4	1	254	1.1	3/8"	1/4"
MBP		114X0702	114X0703	OP-MCHC018SC	SC18MLX	G	H	BG7	0.84	1	300	1.1	1/2"	1/4"
MBP	114X0568			OP-MCGC021SC	SC21MF	G	G	BG4/5	0.4	1	254	1.1	3/8"	1/4"
MBP	114X0564	114X0565	114X0567	OP-MCGC021SC	SC21GX	G	G	BG4/5	0.4	1	254	1.1	3/8"	1/4"
MBP		114X2765	114X2767	OP-MCHC021GS	GS21MLX	G	H	BG7	0.84	1	300	1.6	5/8"	3/8"
MBP		114X0773		OP-MCGC026GS	GS26MFX	G	G	BG7	0.84	1	300	2.4	3/8"	1/4"
MBP		114X0781		OP-MCGC034GS	GS34MFX	G	G	BG7	0.84	1	300	2.4	1/2"	3/8"

## Instructions

### R290 - Technical data

Application	version			Description	Compressor	Electrical code	Refrigerant	Condenser coil		Fan		Receiver Volume (L)	Suction Line (mm)	Liquid line (mm)
	A09	A10	A11					Designation	Internal Volume (L)	Number	Blade (mm)			
LBP	114F0202	114F0203	114F0201	OP-LCNC004NU	NUY45LAb	G	N	BG2	0.25	1	200	0.114	6	6
LBP	114F0205	114F0206	114F0204	OP-LCNC006NU	NUT60CAe	G	N	BG2	0.25	1	200	0.114	6	6
LBP	114F0308	114F0309	114F0307	OP-LCNC008NU	NUY80LAb	G	N	BG3	0.31	1	230	0.114	6	6
LBP	114F0411	114F0412	114F0410	OP-LCNC011NY	NPY12LAb	G	N	BG4/5	0.4	1	254	0.165	8	6
LBP	114F0414	114F0415	114F0413	OP-LCNC016NP	NPT16LA	G	N	BG4/5	0.4	1	254	0.165	8	6
LBP	114F0417	114F0418	114F0416	OP-LCNC023NX	NX23FBa	G	N	BG4/5	0.4	1	254	0.165	10	6
LBP	114F0620	114F0621	114F0619	OP-LCNC034NS	NS34FB	G	N	BG6	0.63	1	300	0.32	12	6
MBP	114F1202	114F1203	114F1201	OP-MCNC003NB	NBC30RA	G	N	BG2	0.25	1	200	0.114	6	6
MBP	114F1205	114F1206	114F1204	OP-MCNC004NU	NUY45RAb	G	N	BG2	0.25	1	200	0.114	6	6
MBP	114F1308	114F1309	114F1307	OP-MCNC006NU	NUY60RAb	G	N	BG3	0.31	1	230	0.114	6	6
MBP	114F1411	114F1412	114F1410	OP-MCNC008NU	NUY80RAb	G	N	BG4/5	0.4	1	254	0.165	6	6
MBP	114F1414	114F1415	114F1413	OP-MCNC009NU	NUY90RAb	G	N	BG4/5	0.4	1	254	0.165	6	6
MBP	114F1417	114F1418	114F1416	OP-MCNC011NY	NLY12RAb	G	N	BG4/5	0.4	1	254	0.165	8	6
MBP	114F1420	114F1421	114F1419	OP-MCNC014NP	NPT14RA	G	N	BG4/5	0.4	1	254	0.165	8	6
MBP	114F1623	114F1624	114F1622	OP-MCNC016NP	NPT16RA	G	N	BG6	0.63	1	300	0.32	8	6
MBP	114F1626	114F1627	114F1625	OP-MCNC018NX	NX18TBa	G	N	BG6	0.63	1	300	0.32	10	6
MBP	114F1629	114F1630	114F1628	OP-MCNC020NX	NX21TBa	G	N	BG6	0.63	1	300	0.32	10	6

### Non catalogue - Technical data

Application	version					Compressor	Refrigerant	Condenser	Fan		Receiver Volume (L)
	T0	T1	T2	N0	N2				Number	Diameter (mm)	
LBP	-	-	-	-	114G1600	TL3F	F	BG2	1	200	0.8
LBP	-	-	114E2471	114H1506	-	TL4CL	CL	BG1	1	170	0.8
LBP	-	-	-	114E2123 114E2227	114G1602	TLS5F	F	BG1	1	170	0.8
LBP	-	-	114H2726	114E2454 114E2503	-	FR6CL	CL	BG2	1	200	0.8
LBP	-	-	-	114G1512	114G1612	NL9F	F	BG2	1	200	0.8
LBP	-	-	-	-	114G2613	NL11F	F	BG2	1	200	0.8
LBP	-	-	-	114E2603	-	NL8.4MF	MF	BG2	1	200	0.8
LBP	-	-	-	114E2577 114H3546	-	NL8.4CLX	CL	BG3	1	230	1.1
LBP	114E2593	114E2517	114H3728	-	-	FR8.5CL	CL	BG3	1	230	1.1
LBP	-	114E2156	114H3730	114E2198 114E2452 114E2534	-	SC10CL	CL	BG3	1	230	1.1
LBP	-	-	-	-	114G1611	NL7F	F	BG4/5	1	254	1.1
LBP	-	-	114H4731	-	-	SC12CL	CL	BG4/5	1	254	1.1
LBP	114E2536	-	114H5732	-	114E2361	SC15CL	CL	BG4/5	1	254	1.1
LBP	114E4007	-	114H5733	114H5533 114E2172	-	SC18CL	CL	BG4/5	1	254	1.1
LBP	114E2353 114E2555 114E4003	-	-	-	-	SC21CL	CL	BG4/5	1	254	1.1
LBP	-	-	114H6735 114H6335	-	-	SC10/10CL	CL	BG6	1	300	2.4
LBP	-	-	114H7736 114H7336 114F5052	-	-	SC12/12CL	CP	BG7	1	300	2.4
LBP	-	-	114H7337 114F5053 114H7737	-	-	SC15/15CL	CL	BG7	1	300	2.4
LBP	114E2546	-	114H7338 114H7738	-	-	SC18/18CL	CP	BG7	1	300	2.4
LBP	-	-	114H7339 114H7739	-	-	SC21/21CL	CP	BG7	1	300	2.4
MBP	-	-	-	114G0503	-	PL35G	G	BG0	1	172	-
MBP	-	-	-	114E2203 114G0502	-	PL50F	F	BG0	1	172	-
MBP	114B0017	-	-	-	-	BD250GH	G	BG0.5	1	172	-
MBP	-	-	114G1706	114G1506	114G1606	TL4G	G	BG1	1	170	0.8
MBP	114E2548	-	114G1708	114E2492 114E2541	-	TL5G	G	BG1	1	170	0.8
MBP	-	-	-	114B0006 114G1901	-	TL4GH	G	BG1	1	170	0.8
MBP	-	-	-	114G2515	114G2615	FR6G	G	BG2	1	200	0.8
MBP	-	-	-	114G2518	-	FR7.5G	G	BG2	1	200	0.8
MBP	114E2346	-	114G2716	114E2201 114E2332 114G2516	114G2616	FR8.5G	G	BG2	1	200	0.8
MBP	114E2410 114E2519 114E2522	-	-	114E2362	-	FR8.5G	G	BG2	1	200	0.8



## Instructions

### Non catalogue - Technical data (continued)

Application	version					Compressor	Refrigerant	Condenser	Fan		Receiver Volume (L)
	T0	T1	T2	N0	N2				Number	Diameter (mm)	
MBP		-	114G2719	-	-	FR10G	G	BG2	1	200	0.8
MBP	114E2347 114E2411 114E2520 114E2544	-	-	114E2333 114E2523	-	SC10G	G	BG2	1	200	0.8
MBP	-	-	114E2527 114H3727	-	-	FR6DL	DL	BG3	1	230	1.1
MBP	-	-	114G3717	114G3517	114G3617	FR11G	G	BG3	1	230	1.1
MBP	-	-	-	114G3536	-	NL10MF	MF	BG3	1	230	1.1
MBP	114E2351 114E2390 114E2549 114E2545 114E2457 114E2521	-	114G3726	114E2434 114G3526 114G9350 114G4565	114G3626	SC12G	G	BG3	1	230	1.1
MBP	-	-	114E2528 114H5743	-	-	SC10DL	DL	BG4/5	1	254	1.1
MBP	-	-	114H5744	-	-	SC12DL	DL	BG4/5	1	254	1.1
MBP	114E2352 114E2391 114E2550	-	114G4727	114E2435 114G4527	114G4627	SC15G	G	BG4/5	1	254	1.1
MBP	114E2442 114E2567 114E4023	-	114G5728	114E2357 114E2418 114G5528	-	SC18G	G	BG4/5	1	254	1.1
MBP	114E2459 114E2551	-	114G5730	114E2419 114G5530	-	SC21G	G	BG4/5	1	254	1.1
MBP	114E2540	-	114E2529 114H6745	-	-	SC15DL	DL	BG6	1	300	2.4
MBP	-	-	114E2586	-	-	SC15MLX	ML	BG6	1	300	2.4
MBP	-	-	114E2587	-	-	SC18MLX	ML	BG7	1	300	2.4
MBP	-	-	114G6380 114G6780	-	-	SC12/12G	G	BG6	1	300	2.4
MBP	-	-	114H7347 114H7747	-	-	SC10/10DL	DL	BG7	1	300	2.4
MBP	-	-	114H7348 114H7748	-	-	SC12/12DL	DL	BG7	1	300	2.4
MBP	-	-	114G7381 114G7781	-	-	SC15/15G	G	BG7	1	300	2.4
MBP	-	-	114H7349 114H7749	-	-	SC15/15DL	DL	BG7	1	300	2.4
MBP	114E2128	-	114G7382 114G7782	-	-	SC18/18G	G	BG7	1	300	2.4
MBP	114E2149	-	114G7383 114G7783	-	-	SC21/21G	G	BG7	1	300	2.4
LBP/MBP	-	-	-	114F1504	-	TL5CN	CN	BG1	1	170	-
LBP/MBP	-	-	-	114F1508	-	TL4CN	CN	BG1	1	170	-
LBP/MBP	-	-	-	114F2505	-	NL7CN	CN	BG2	1	200	-
LBP/MBP	-	-	-	114F3500	-	SC10CN	CN	BG3	1	230	-
LBP/MBP	-	-	-	114F3509	-	NL9CN	CN	BG2	1	200	-
LBP/MBP	-	-	-	114F4501	-	SC12CN	CN	BG4/5	1	254	-
LBP/MBP	-	-	-	114F4502	-	SC15CN	CN	BG4/5	1	254	-
LBP/MBP	-	-	-	114F4503	-	SC18CN	CN	BG4/5	1	254	-

Based on request Power cord added to non catalogue models

### UL - Technical data

Application	Version				Compressor	Refrigerant	Condenser	Fan		Receiver Volume (L)
	T0	T1	T2	N0				Number	Diameter (mm)	
LBP			114G2573		NL11F	F	BG2	1	200	0.8
LBP	114E2403				SC10CLX	CL	BG3	1	230	1.2
LBP	114H4515		114E4018		SC12CL	CL	BG4/5	1	254	1.1
LBP				114H5953	SC18CLX	CL	BG4/5	1	254	1.1
LBP			114E2495		SC15CLX	CL	BG4/5	1	254	1.1
LBP			114E4024		SC15CLX	CL	BG4/5	1	254	1.1
LBP				114F5062	SC12/12CL	CL	BG4/5	1	254	1.1
LBP	114F0207 114F0208				DLE4.8CN	CN	BG2	1	200	0.8
MBP	114G1900	114G1660		114G1760 114G1940	TL4G	G	BG1	1	170	0.8
MBP			114E4020		FF8.5GX	G	BG3	1	230	1.2
MBP			114E4021	114G3768	FF10GX	G	BG3	1	230	1.2
MBP	114E2397		114E4022	114G3942	SC12G	G	BG3	1	230	1.2
MBP			114E4002		SC15G	G	BG4/5	1	254	1.1
MBP				114G5946	SC18GH	G	BG4/5	1	254	1.1

## Anleitungen

### Bilag - A, Tekniske data

#### Mærkatoplysninger

<b>Optyma™</b> by Danfoss			
<b>EAN No :</b>			<b>MADE IN ITALY</b>
<b>B</b> Serial No 29XXXXXXXX			
<b>C</b> Refrigerant: (1) Rxxxx (2)		<b>114X1219</b>	<b>A</b>
		<b>Model: XXXXXXXX</b>	<b>D</b>
Max. Working Pressure HP (1) xx  According with EN 378 and temperature 46°C		Comp: xxx-xxxV xxHz Fan: xxx-xxxV xxHz-xxHz Refr. Charge < 150g	<b>E</b>
If imported from UK - Danfoss Ltd., 22 Wycombe End, HP9 1NB, GB Імпортёр: ТОВ з іі "Данфосс ТОВ" 04080, Київ 80, п/с 168, Україна			

**A:** Bestillingsnummer for condensing unit

**B:** Produktionsserienummer

**C:** Kølemiddel

**D:** Modelbetegnelse

**E:** Strømforsyning til kompressor og ventilatormotor

### Betegnelse – katalog

**OP - LCQN 048 MT A00 E**

OP = Optyma

1 2 3 4 5 6 7 8

1	<b>Applikation:</b> <b>M</b> = Mellemløjt modtryk; <b>L</b> = Lavt modtryk
2	<b>Kompressor type:</b> <b>C:</b> Luftkølet condensing unit med enkeltventilator
3	<b>Kølemiddel:</b> <b>G:</b> R134a, R513A; H: R404A/R507; <b>Q:</b> R452A, R404A/R507; <b>N:</b> R290
4	<b>Kondensatordesign:</b> <b>C:</b> Finne- og rørkondensator, omgivelsestemperatur op til 43 °C
5	<b>Slagvolum for kompressor:</b> Eksempel 048 = 48 cm <sup>3</sup>
6	<b>Stempel kompressor type:</b> FR = FR, NF = NF, SC = SC, GS = GS, NX = NX, NB = NBC, NS = NS, NU = NUY, NP = NPT, MP = MPT, MY = MLY, MX = MX, TL = TL, NL = NL
7	<b>Versjon:</b> A00, A01, A04, A09, A10, A11. Se tabellen Funktionsoversigt for funktioner i hver version.
8	<b>Elektrisk kode:</b> G: Kompressor 230V/1P/50Hz, ventilator 230V/1P/50Hz E: Kompressor 400V/3P/50Hz, ventilator 230V/1P/50Hz

	Light Commercial			Light Commercial R290		
	A00	A01	A04	A09	A10	A11
Omgivelsestemperatur	Op til 43 °C			Op til 43 °C		
Hermetisk stempelkompressor type	MPT, MLY, NL, SC, GS, FR, TL, NF			NUY, NBC, NPT, NS, NX		
Enhedens sokkel	Skinner eller bundplade					
Kondensatortype	Finne og rør (malet)					
Ventilator	AC/EC	AC/EC	AC/EC	EC	EC	EC
Konsol og rør til pressostatmontering	-	ja	ja	ja	-	-
Dobbelt pressostat - KP 17 WB	-	-	ja	-	-	-
Schrader-ventil	-	-	-	ja	ja	ja
Tilsluttet elektrisk boks	ja	ja	ja	ja	ja	ja
Mini HP/LP-pressostat	-	-	-	-	ja	-
Strømledning	-	-	ja	-	ja	-
Receiver	-	ja	ja	-	Kombi filter + receiver	-

## Anleitungen

### Betegnelse – Ikke katalog

#### SC18GXT2

T T T T T  
1 2 3 4 5

1	<b>Kompressor type:</b> PL, TL, NL, FR, SC, GS
2	<b>Slagvolum for kompressor:</b> Eksempel 048 = 48 cm <sup>3</sup>
3	<b>Applikation og kølemiddel:</b> <b>CM</b> = LBP; R22 <b>CL</b> = LBP; R404A/R507 <b>CN</b> = LBP/MBP; R290 <b>CP</b> = LBP; R404A/R507, R452A <b>DM</b> = HBP; R22 <b>DL</b> = HBP; R404A/R507 <b>F</b> = LBP/(MBP); R134a <b>FT</b> = LBP tropisk; R134a <b>G</b> = LBP/MBP/HBP; R134a og R513A <b>GH</b> = Varmepumpe optimeret; R134a <b>MF</b> = MBP; R134a <b>ML</b> = MBP; R404A/507
4	<b>Startegenskaber:</b> <b>X</b> = HST <b>K</b> = LST
5	<b>Version:</b> N0 – Til kapillarrør – uden stopventiler, uden receiver N1 – Til kapillarrør – med 1x stopventil, uden receiver N2 – Til kapillarrør – med 2 x stopventil, uden receiver T0 – Til ekspansionsventil – med receiver uden 2 x stopventiler T1 – Til ekspansionsventil – med receiver med 1x stopventil T2 – Til ekspansionsventil – med receiver med 2 x stopventiler

	Light Commercial					
	N0	N1	N2	T0	T1	T2
Omgivelsestemperatur	Op til 43 °C					
Hermetisk stempelkompressor	NL, SC, GS, FR, TL, NF, DL					
Enhedens sokkel	Skinner eller bundplade					
Kondensatortype	Finne og rør (malet)					
Schrader-ventil	-	-	-	ja	ja	ja
Tilsluttet elektrisk boks	ja	ja	ja	ja	ja	ja
Serviceventil	-	ja*	ja	-	ja*	ja
Receiver	-	-	-	ja	ja	ja

\*) 1X Serviceventil

## Anleitungen

### Katalogmodeller

#### Light Commercial – Tekniske data

Applikation	Version			Beskrivelse	Kompressor	Elektrisk kode	Kølemiddel	Kondensator		Ventilator		Receiver-volumen (L)	Sugegas-ledning	Væske-ledning
	A00	A01	A04					Betegnelse	Intern volumen (L)	Antal	Vinge (mm)			
LBP	114X1208	114X1209	114X1211	OP-LCHC004TL	TL4CL	G	H	BG2	0,25	1	200	0,8	1/4"	1/4"
LBP		114X1221		OP-LCQC004ML	MLY45Lab	G	Q	BG2	0,25	1	200	0,8	3/8"	1/4"
LBP	114X1216	114X1217	114X1219	OP-LCHC006FR	FR6CL	G	H	BG2	0,25	1	200	0,8	3/8"	1/4"
LBP		114X1337		OP-LCQC006ML	MLY60Lab	G	Q	BG3	0,31	1	230	1,1	3/8"	1/4"
LBP	114X1328	114X1329	114X1331	OP-LCHC007NL	NL7CLX	G	H	BG3	0,31	1	230	1,1	3/8"	1/4"
LBP	114X1324	114X1325	114X1327	OP-LCHC008FR	FR8.5CL	G	H	BG3	0,31	1	230	1,1	3/8"	1/4"
LBP	114X1304	114X1301	114X1302	OP-LCHC008NL	NL8.4CLX	G	H	BG3	0,31	1	230	1,1	3/8"	1/4"
LBP		114X1341		OP-LCQC008ML	MLY80Lab	G	Q	BG3	0,31	1	230	1,1	3/8"	1/4"
LBP	114X1440	114X1441	114X1443	OP-LCHC012SC	SC12CL	G	H	BG4/5	0,4	1	254	1,1	3/8"	1/4"
LBP	114X1444			OP-LCHC012SC	SC12CLX.2	G	H	BG4/5	0,4	1	254	1,1	3/8"	1/4"
LBP		114X1449		OP-LCQC012ML	MLY12Lab	G	Q	BG4/5	0,4	1	254	1,1	3/8"	1/4"
LBP		114X1569		OP-LCQC012MP	MPT12LA	G	Q	BG4/5	0,4	1	254	1,1	3/8"	1/4"
LBP		114X1573		OP-LCQC014MP	MPT14LA	G	Q	BG4/5	0,4	1	254	1,1	1/2"	1/4"
LBP	114X1548	114X1549	114X1551	OP-LCHC015SC	SC15CLX	G	H	BG4/5	0,4	1	254	1,1	3/8"	1/4"
LBP	114X1556	114X1557	114X1559	OP-LCHC018SC	SC18CL	G	H	BG4/5	0,4	1	254	1,1	1/2"	1/4"
LBP	114X1600	114X1601	114X1602	OP-LCHC021SC	SC21CL	G	H	BG6	0,63	1	300	1,1	1/2"	1/4"
LBP		114X1673		OP-LCHC026GS	GS26CLX	G	H	BG6	0,63	1	300	2,4	1/2"	3/8"
LBP		114X1781	114X1783	OP-LCHC034GS	GS34CLX	G	H	BG7	0,84	1	300	2,4	1/2"	3/8"
MBP	114X0104	114X0105	114X0107	OP-MCGC003TL	TL3GX	G	G	BG1	0,13	1	172	0,8	1/4"	1/4"
MBP	114X0108	114X0109	114X0111	OP-MCGC004TL	TL4GX	G	G	BG1	0,13	1	172	0,8	1/4"	1/4"
MBP	114X0301	114X0302	114X0303	OP-MCHC004TL	TL4DL	G	H	BG3	0,31	1	230	1,1	3/8"	1/4"
MBP	114X0112	114X0113	114X0115	OP-MCGC005TL	TL5GX	G	G	BG1	0,13	1	172	0,8	1/4"	1/4"
MBP	114X0200	114X0201	114X0203	OP-MCGC006FR	FR6GX	G	G	BG2	0,25	1	200	0,8	3/8"	1/4"
MBP	114X2316	114X2317	114X2319	OP-MCHC006FR	FR6DLX	G	H	BG3	0,31	1	230	1,1	3/8"	1/4"
MBP	114X0228			OP-MCGC006NL	NL6.1MF	G	G	BG2	0,25	1	200	0,8	3/8"	1/4"
MBP	114X0216	114X0217	114X0219	OP-MCGC007FR	FR7.5GX	G	G	BG2	0,25	1	200	0,8	3/8"	1/4"
MBP	114X0244			OP-MCGC007NL	NL7.3MF	G	G	BG2	0,25	1	200	0,8	3/8"	1/4"
MBP	114X2424	114X2425	114X2427	OP-MCHB007NF	NF7MLX	G	H	BG4/5	0,4	1	254	1,1	3/8"	1/4"
MBP	114X0224	114X0225	114X0227	OP-MCGC008FR	FR8.5GX	G	G	BG2	0,25	1	200	0,8	3/8"	1/4"
MBP	114X0204	114X0205		OP-MCGC008NL	NL8.4MF	G	G	BG2	0,25	1	200	0,8	3/8"	1/4"
MBP	114X0352			OP-MCGC008NL	NL8.4MF	G	G	BG3	0,31	1	230	-	3/8"	1/4"
MBP			114X0223	OP-MCGC010SC	SC10GX	G	G	BG2	0,25	1	200	0,8	3/8"	1/4"
MBP	114X0403	114X0404	114X0405	OP-MCHC010SC	SC10MLX	G	H	BG4/5	0,4	1	254	1,1	3/8"	1/4"
MBP	114X0336	114X0337	114X0339	OP-MCGC011FR	FR11GX	G	G	BG3	0,31	1	230	1,1	3/8"	1/4"
MBP	114X0340	114X0341	114X0343	OP-MCGC012SC	SC12GX	G	G	BG3	0,31	1	230	1,1	3/8"	1/4"
MBP	114X0406	114X0407	114X0408	OP-MCHC013SC	SC12MLX	G	H	BG4/5	0,4	1	254	1,1	3/8"	1/4"
MBP	114X0448	114X0449	114X0451	OP-MCGC015SC	SC15GX	G	G	BG4/5	0,4	1	254	1,1	3/8"	1/4"
MBP		114X2649	114X2651	OP-MCHC015SC	SC15MLX	G	H	BG6	1,1	1	300	1,1	1/2"	1/4"
MBP	114X0556	114X0557	114X0559	OP-MCGC018SC	SC18G	G	G	BG4/5	0,4	1	254	1,1	3/8"	1/4"
MBP		114X0702	114X0703	OP-MCHC018SC	SC18MLX	G	H	BG7	0,84	1	300	1,1	1/2"	1/4"
MBP	114X0568			OP-MCGC021SC	SC21MF	G	G	BG4/5	0,4	1	254	1,1	3/8"	1/4"
MBP	114X0564	114X0565	114X0567	OP-MCGC021SC	SC21GX	G	G	BG4/5	0,4	1	254	1,1	3/8"	1/4"
MBP		114X2765	114X2767	OP-MCHC021GS	GS21MLX	G	H	BG7	0,84	1	300	1,6	5/8"	3/8"
MBP		114X0773		OP-MCGC026GS	GS26MFX	G	G	BG7	0,84	1	300	2,4	3/8"	1/4"
MBP		114X0781		OP-MCGC034GS	GS34MFX	G	G	BG7	0,84	1	300	2,4	1/2"	3/8"

## Anleitungen

### R290 – Tekniske data

Applikation	Version			Beskrivelse	Kompressor	Elektrisk kode	Kølemiddel	Kondensator		Ventilator		Receiver-volumen (L)	Sugeledning (mm)	Væskeledning (mm)
	A09	A10	A11					Betegnelse	Intern volumen (L)	Antal	Vinge (mm)			
LBP	114F0202	114F0203	114F0201	OP-LCNC004NU	NUY45LAb	G	N	BG2	0,25	1	200	0,114	6	6
LBP	114F0205	114F0206	114F0204	OP-LCNC006NU	NUT60CAe	G	N	BG2	0,25	1	200	0,114	6	6
LBP	114F0308	114F0309	114F0307	OP-LCNC008NU	NUY80LAb	G	N	BG3	0,31	1	230	0,114	6	6
LBP	114F0411	114F0412	114F0410	OP-LCNC011NY	NPY12LAb	G	N	BG4/5	0,4	1	254	0,165	8	6
LBP	114F0414	114F0415	114F0413	OP-LCNC016NP	NPT16LA	G	N	BG4/5	0,4	1	254	0,165	8	6
LBP	114F0417	114F0418	114F0416	OP-LCNC023NX	NX23FBa	G	N	BG4/5	0,4	1	254	0,165	10	6
LBP	114F0620	114F0621	114F0619	OP-LCNC034NS	NS34FB	G	N	BG6	0,63	1	300	0,32	12	6
MBP	114F1202	114F1203	114F1201	OP-MCNC003NB	NBC30RA	G	N	BG2	0,25	1	200	0,114	6	6
MBP	114F1205	114F1206	114F1204	OP-MCNC004NU	NUY45RAb	G	N	BG2	0,25	1	200	0,114	6	6
MBP	114F1308	114F1309	114F1307	OP-MCNC006NU	NUY60RAb	G	N	BG3	0,31	1	230	0,114	6	6
MBP	114F1411	114F1412	114F1410	OP-MCNC008NU	NUY80RAb	G	N	BG4/5	0,4	1	254	0,165	6	6
MBP	114F1414	114F1415	114F1413	OP-MCNC009NU	NUY90RAb	G	N	BG4/5	0,4	1	254	0,165	6	6
MBP	114F1417	114F1418	114F1416	OP-MCNC011NY	NLY12RAb	G	N	BG4/5	0,4	1	254	0,165	8	6
MBP	114F1420	114F1421	114F1419	OP-MCNC014NP	NPT14RA	G	N	BG4/5	0,4	1	254	0,165	8	6
MBP	114F1623	114F1624	114F1622	OP-MCNC016NP	NPT16RA	G	N	BG6	0,63	1	300	0,32	8	6
MBP	114F1626	114F1627	114F1625	OP-MCNC018NX	NX18TBa	G	N	BG6	0,63	1	300	0,32	10	6
MBP	114F1629	114F1630	114F1628	OP-MCNC020NX	NX21TBa	G	N	BG6	0,63	1	300	0,32	10	6

### Ikke katalog – Tekniske data

Applikation	Version					Kompressor	Kølemiddel	Kondensator	Ventilator		Receiver-volumen(L)
	T0	T1	T2	N0	N2				Antal	Diameter (mm)	
LBP	-	-	-	-	114G1600	TL3F	F	BG2	1	200	0,8
LBP	-	-	114E2471	114H1506	-	TL4CL	CL	BG1	1	170	0,8
LBP	-	-	-	114E2123 114E2227	114G1602	TL55F	F	BG1	1	170	0,8
LBP	-	-	114H2726	114E2454 114E2503	-	FR6CL	CL	BG2	1	200	0,8
LBP	-	-	-	114G1512	114G1612	NL9F	F	BG2	1	200	0,8
LBP	-	-	-	-	114G2613	NL11F	F	BG2	1	200	0,8
LBP	-	-	-	114E2603	-	NL8.4MF	MF	BG2	1	200	0,8
LBP	-	-	-	114E2577 114H3546	-	NL8.4CLX	CL	BG3	1	230	1,1
LBP	114E2593	114E2517	114H3728	-	-	FR8.5CL	CL	BG3	1	230	1,1
LBP	-	114E2156	114H3730	114E2198 114E2452 114E2534	-	SC10CL	CL	BG3	1	230	1,1
LBP	-	-	-	-	114G1611	NL7F	F	BG4/5	1	254	1,1
LBP	-	-	114H4731	-	-	SC12CL	CL	BG4/5	1	254	1,1
LBP	114E2536	-	114H5732	-	114E2361	SC15CL	CL	BG4/5	1	254	1,1
LBP	114E4007	-	114H5733	114H5533 114E2172	-	SC18CL	CL	BG4/5	1	254	1,1
LBP	114E2353 114E2555 114E4003	-	-	-	-	SC21CL	CL	BG4/5	1	254	1,1
LBP	-	-	114H6735 114H6335	-	-	SC10/10CL	CL	BG6	1	300	2,4
LBP	-	-	114H7736 114H7336 114F5052	-	-	SC12/12CL	CP	BG7	1	300	2,4
LBP	-	-	114H7337 114F5053 114H7737	-	-	SC15/15CL	CL	BG7	1	300	2,4
LBP	114E2546	-	114H7338 114H7738	-	-	SC18/18CL	CP	BG7	1	300	2,4
LBP	-	-	114H7339 114H7739	-	-	SC21/21CL	CP	BG7	1	300	2,4
MBP	-	-	-	114G0503	-	PL35G	G	BG0	1	172	-
MBP	-	-	-	114E2203 114G0502	-	PL50F	F	BG0	1	172	-
MBP	114B0017	-	-	-	-	BD250GH	G	BG0.5	1	172	-
MBP	-	-	114G1706	114G1506	114G1606	TL4G	G	BG1	1	170	0,8
MBP	114E2548	-	114G1708	114E2492 114E2541	-	TL5G	G	BG1	1	170	0,8
MBP	-	-	-	114B0006 114G1901	-	TL4GH	G	BG1	1	170	0,8
MBP	-	-	-	114G2515	114G2615	FR6G	G	BG2	1	200	0,8
MBP	-	-	-	114G2518	-	FR7.5G	G	BG2	1	200	0,8
MBP	114E2346	-	114G2716	114E2201 114E2332 114G2516	114G2616	FR8.5G	G	BG2	1	200	0,8
MBP	114E2410 114E2519 114E2522	-	-	114E2362	-	FR8.5G	G	BG2	1	200	0,8

## Anleitungen

### Ikke katalog – Tekniske data (fortsat)

Applikation	Version					Kompressor	Kølemiddel	Kondensator	Ventilator		Receiver-volumen(L)
	T0	T1	T2	N0	N2				Antal	Diameter (mm)	
MBP		-	114G2719	-	-	FR10G	G	BG2	1	200	0,8
MBP	114E2347 114E2411 114E2520 114E2544	-	-	114E2333 114E2523	-	SC10G	G	BG2	1	200	0,8
MBP	-	-	114E2527 114H3727	-	-	FR6DL	DL	BG3	1	230	1,1
MBP	-	-	114G3717	114G3517	114G3617	FR11G	G	BG3	1	230	1,1
MBP	-	-	-	114G3536	-	NL10MF	MF	BG3	1	230	1,1
MBP	114E2351 114E2390 114E2549 114E2545 114E2457 114E2521	-	114G3726	114E2434 114G3526 114G9350 114G4565	114G3626	SC12G	G	BG3	1	230	1,1
MBP	-	-	114E2528 114H5743	-	-	SC10DL	DL	BG4/5	1	254	1,1
MBP	-	-	114H5744	-	-	SC12DL	DL	BG4/5	1	254	1,1
MBP	114E2352 114E2391 114E2550	-	114G4727	114E2435 114G4527	114G4627	SC15G	G	BG4/5	1	254	1,1
MBP	114E2442 114E2567 114E4023	-	114G5728	114E2357 114E2418 114G5528	-	SC18G	G	BG4/5	1	254	1,1
MBP	114E2459 114E2551	-	114G5730	114E2419 114G5530	-	SC21G	G	BG4/5	1	254	1,1
MBP	114E2540	-	114E2529 114H6745	-	-	SC15DL	DL	BG6	1	300	2,4
MBP	-	-	114E2586	-	-	SC15MLX	ML	BG6	1	300	2,4
MBP	-	-	114E2587	-	-	SC18MLX	ML	BG7	1	300	2,4
MBP	-	-	114G6380 114G6780	-	-	SC12/12G	G	BG6	1	300	2,4
MBP	-	-	114H7347 114H7747	-	-	SC10/10DL	DL	BG7	1	300	2,4
MBP	-	-	114H7348 114H7748	-	-	SC12/12DL	DL	BG7	1	300	2,4
MBP	-	-	114G7381 114G7781	-	-	SC15/15G	G	BG7	1	300	2,4
MBP	-	-	114H7349 114H7749	-	-	SC15/15DL	DL	BG7	1	300	2,4
MBP	114E2128	-	114G7382 114G7782	-	-	SC18/18G	G	BG7	1	300	2,4
MBP	114E2149	-	114G7383 114G7783	-	-	SC21/21G	G	BG7	1	300	2,4
LBP/MBP	-	-	-	114F1504	-	TL5CN	CN	BG1	1	170	-
LBP/MBP	-	-	-	114F1508	-	TL4CN	CN	BG1	1	170	-
LBP/MBP	-	-	-	114F2505	-	NL7CN	CN	BG2	1	200	-
LBP/MBP	-	-	-	114F3500	-	SC10CN	CN	BG3	1	230	-
LBP/MBP	-	-	-	114F3509	-	NL9CN	CN	BG2	1	200	-
LBP/MBP	-	-	-	114F4501	-	SC12CN	CN	BG4/5	1	254	-
LBP/MBP	-	-	-	114F4502	-	SC15CN	CN	BG4/5	1	254	-
LBP/MBP	-	-	-	114F4503	-	SC18CN	CN	BG4/5	1	254	-

Baseret på anmodning Strømledning tilføjet til ikke-katalogmodeller

### UL – Tekniske data

Applikation	Version				Kompressor	Kølemiddel	Kondensator	Ventilator		Receiver-volumen (L)
	T0	T1	T2	N0				Antal	Diameter (mm)	
LBP			114G2573		NL11F	F	BG2	1	200	0,8
LBP	114E2403				SC10CLX	CL	BG3	1	230	1,2
LBP	114H4515		114E4018		SC12CL	CL	BG4/5	1	254	1,1
LBP				114H5953	SC18CLX	CL	BG4/5	1	254	1,1
LBP			114E2495		SC15CLX	CL	BG4/5	1	254	1,1
LBP			114E4024		SC15CLX	CL	BG4/5	1	254	1,1
LBP				114F5062	SC12/12CL	CL	BG4/5	1	254	1,1
LBP	114F0207 114F0208				DLE4.8CN	CN	BG2	1	200	0,8
MBP	114G1900	114G1660		114G1760 114G1940	TL4G	G	BG1	1	170	0,8
MBP			114E4020		FF8.5GX	G	BG3	1	230	1,2
MBP			114E4021	114G3768	FF10GX	G	BG3	1	230	1,2
MBP	114E2397		114E4022	114G3942	SC12G	G	BG3	1	230	1,2
MBP			114E4002		SC15G	G	BG4/5	1	254	1,1
MBP				114G5946	SC18GH	G	BG4/5	1	254	1,1

# Instruktioner

## Anhang – A, Technische Daten

### Etiketteninformationen

<b>Optyma™</b> by Danfoss			
<b>EAN No :</b>			<b>MADE IN ITALY</b>
<b>Serial No 29XXXXXXX</b>			
<b>Refrigerant:</b> (1) Rxxxx (2)	<b>114X1219</b>	<b>Model: XXXXXXXX</b>	<b>A</b>
<b>Max. Working Pressure</b> HP (1) xx	Comp: xxx- xxxV xxHz Fan: xxx- xxxV xxHz- xxHz Refr. Charge < 150g		<b>D</b>
According with EN 378 and temperature 46°C	If imported from UK - Danfoss Ltd., 22 Wycombe End, HP9 1NB, GB Імпортер: ТОВ з іі "Данфосс ТОВ" 04080, Київ 80, п/с 168, Україна		<b>E</b>

- A:** Artikelnummer des Verflüssigungssatzes
- B:** Produktionsseriennummer
- C:** Kältemittel
- D:** Typenbezeichnung
- E:** Versorgungsspannung für Verdichter und Lüftermotor

## Bezeichnung – Katalog

**OP – LCQN 048 MT A00 E**

OP = Optyma

1 2 3 4 5 6 7 8  
 | | | | | | | |

1	<b>Anwendung:</b> <b>M</b> = Mittlerer Saugdruck; <b>L</b> = Niedriger Saugdruck
2	<b>Verdichterplattform:</b> <b>C:</b> Luftgekühlter Verflüssigungssatz mit einem Lüfter
3	<b>Kältemittel:</b> <b>G:</b> R134a, R513A; <b>H:</b> R404A/R507; <b>Q:</b> R452A, R404A/R507; <b>N:</b> R290
4	<b>Verflüssigerart:</b> <b>C:</b> Alu-Lamellen-Kupferrohr-Verflüssiger, Umgebungstemperatur bis zu 43 °C
5	<b>Verdichter-Hubvolumen:</b> Beispiel 048 = 48 cm <sup>3</sup>
6	<b>Hubkolbenverdichterplattform:</b> FR = FR, NF = NF, SC = SC, GS = GS, NX = NX, NB = NBC, NS = NS, NU = NUY, NP = NPT, MP = MPT, MY = MLY, MX = MX, TL = TL, NL = NL
7	<b>Version:</b> A00, A01, A04, A09, A10, A11. Siehe Tabelle „Funktionsübersicht“ bezüglich Funktionen innerhalb jeder Version.
8	<b>Spannungscodes:</b> G: Verdichter 230 V/1P/50 Hz; Lüfter 230 V/1P/50 Hz E: Verdichter 400 V/3P/50 Hz; Lüfter 230 V/1P/50 Hz

	Light Commercial			Light Commercial R290		
	A00	A01	A04	A09	A10	A11
Umgebungstemperatur	Bis zu 43 °C			Bis zu 43 °C		
Vollhermetische Hubkolbenverdichterplattform	MPT, MLY, NL, SC, GS, FR, TL, NF			NUY, NBC, NPT, NS, NX		
Grundrahmen	Schienen oder Fußplatte					
Verflüssigertyp	Alu-Lamellen-Kupferrohr-Verflüssiger (lackiert)					
Lüfter	AC/EC	AC/EC	AC/EC	EC	EC	EC
Befestigungswinkel und Anschlußrohre für Pressostat-Montage	-	ja	ja	ja	-	-
Doppeldruckschalter – KP 17 WB	-	-	ja	-	-	-
Schraderventil	-	-	-	ja	ja	ja
Verdrahteter Anschlusskasten	ja	ja	ja	ja	ja	ja
HD/ND-Patronendruckschalter	-	-	-	-	ja	-
Anschlusskabel	-	-	ja	-	ja	-
Sammler	-	ja	ja	-	Sammler-trockner	-

## Instruktionen

### Bezeichnung – Nicht-Katalog

#### SC 18 G X T2

T T T T T  
1 2 3 4 5

1	<b>Verdichterplattform:</b> PL, TL, NL, FR, SC, GS
2	<b>Verdichter-Hubvolumen:</b> Beispiel 048 = 48 cm <sup>3</sup>
3	<b>Anwendung und Kältemittel:</b> <b>CM</b> = LBP; R22 <b>CL</b> = LBP; R404A/R507 <b>CN</b> = LBP/MBP; R290 <b>CP</b> = LBP; R404A/R507, R452A <b>DM</b> = HBP; R22 <b>DL</b> = HBP; R404A/R507 <b>F</b> = LBP/(MBP); R134a <b>FT</b> = LBP tropentauglich; R134a <b>G</b> = LBP/MBP/HBP; R134a und R513A <b>GH</b> = Wärmepumpenoptimiert; R134a <b>MF</b> = MBP; R134a <b>ML</b> = MBP; R404A/507
4	<b>Start-Eigenschaften:</b> <b>X</b> = HST <b>K</b> = LST
5	<b>Version:</b> N0 – für Kapillarrohrbetrieb – ohne Absperrventile, ohne Sammler N1 – für Kapillarrohrbetrieb – mit 1 Absperrventil, ohne Sammler N2 – für Kapillarrohrbetrieb – mit 2 Absperrventilen, ohne Sammler T0 – für Expansionsventil – mit Sammler ohne Absperrventile T1 – für Expansionsventil – mit Sammler mit 1 Absperrventil T2 – für Expansionsventil – mit Sammler mit 2 Absperrventilen

	Light Commercial					
	N0	N1	N2	T0	T1	T2
Umgebungstemperatur	Bis zu 43 °C					
Vollhermetische Hubkolbenverdichter	NL, SC, GS, FR, TL, NF, DL					
Grundrahmen	Schienen oder Fußplatte					
Verflüssigertyp	Alu-Lamellen-Kupferrohr-Verflüssiger (lackiert)					
Schraderventil	-	-	-	ja	ja	ja
Verdrahteter Anschlusskasten	ja	ja	ja	ja	ja	ja
Serviceventil	-	ja*	ja	-	ja*	ja
Sammler	-	-	-	ja	ja	ja

\*) 1X Service ventil



## Instruktioner

### Katalogtypen

#### Light Commercial – Technische Daten

Anwendung	Version			Beschreibung	Verdichter	Spannungs- code	Kältemittel	Verflüssiger		Lüfter		Sammler- inhalt (l)	Saugleitung	Flüssigkeits- leitung
	A00	A01	A04					Bezeichnung	Innen- volumen (l)	Nummer	Flügel (mm)			
LBP (Tiefkühlung)	114X1208	114X1209	114X1211	OP-LCHC004TL	TL4CL	G	H	BG2	0,25	1	200	0,8	1/4"	1/4"
LBP (Tiefkühlung)		114X1221		OP-LCQC004ML	MLY45Lab	G	Q	BG2	0,25	1	200	0,8	3/8"	1/4"
LBP (Tiefkühlung)	114X1216	114X1217	114X1219	OP-LCHC006FR	FR6CL	G	H	BG2	0,25	1	200	0,8	3/8"	1/4"
LBP (Tiefkühlung)		114X1337		OP-LCQC006ML	MLY60Lab	G	Q	BG3	0,31	1	230	1,1	3/8"	1/4"
LBP (Tiefkühlung)	114X1328	114X1329	114X1331	OP-LCHC007NL	NL7CLX	G	H	BG3	0,31	1	230	1,1	3/8"	1/4"
LBP (Tiefkühlung)	114X1324	114X1325	114X1327	OP-LCHC008FR	FR8.5CL	G	H	BG3	0,31	1	230	1,1	3/8"	1/4"
LBP (Tiefkühlung)	114X1304	114X1301	114X1302	OP-LCHC008NL	NL8.4CLX	G	H	BG3	0,31	1	230	1,1	3/8"	1/4"
LBP (Tiefkühlung)		114X1341		OP-LCQC008ML	MLY80Lab	G	Q	BG3	0,31	1	230	1,1	3/8"	1/4"
LBP (Tiefkühlung)	114X1440	114X1441	114X1443	OP-LCHC012SC	SC12CL	G	H	BG4/5	0,4	1	254	1,1	3/8"	1/4"
LBP (Tiefkühlung)	114X1444			OP-LCHC012SC	SC12CLX.2	G	H	BG4/5	0,4	1	254	1,1	3/8"	1/4"
LBP (Tiefkühlung)		114X1449		OP-LCQC012ML	MLY12Lab	G	Q	BG4/5	0,4	1	254	1,1	3/8"	1/4"
LBP (Tiefkühlung)		114X1569		OP-LCQC012MP	MPT12LA	G	Q	BG4/5	0,4	1	254	1,1	3/8"	1/4"
LBP (Tiefkühlung)		114X1573		OP-LCQC014MP	MPT14LA	G	Q	BG4/5	0,4	1	254	1,1	1/2"	1/4"
LBP (Tiefkühlung)	114X1548	114X1549	114X1551	OP-LCHC015SC	SC15CLX	G	H	BG4/5	0,4	1	254	1,1	3/8"	1/4"
LBP (Tiefkühlung)	114X1556	114X1557	114X1559	OP-LCHC018SC	SC18CL	G	H	BG4/5	0,4	1	254	1,1	1/2"	1/4"
LBP (Tiefkühlung)	114X1600	114X1601	114X1602	OP-LCHC021SC	SC21CL	G	H	BG6	0,63	1	300	1,1	1/2"	1/4"
LBP (Tiefkühlung)		114X1673		OP-LCHC026GS	GS26CLX	G	H	BG6	0,63	1	300	2,4	1/2"	3/8"
LBP (Tiefkühlung)		114X1781	114X1783	OP-LCHC034GS	GS34CLX	G	H	BG7	0,84	1	300	2,4	1/2"	3/8"
MBP (Normalkühlung)	114X0104	114X0105	114X0107	OP-MCGC003TL	TL3GX	G	G	BG1	0,13	1	172	0,8	1/4"	1/4"
MBP (Normalkühlung)	114X0108	114X0109	114X0111	OP-MCGC004TL	TL4GX	G	G	BG1	0,13	1	172	0,8	1/4"	1/4"
MBP (Normalkühlung)	114X0301	114X0302	114X0303	OP-MCHC004TL	TL4DL	G	H	BG3	0,31	1	230	1,1	3/8"	1/4"
MBP (Normalkühlung)	114X0112	114X0113	114X0115	OP-MCGC005TL	TL5GX	G	G	BG1	0,13	1	172	0,8	1/4"	1/4"
MBP (Normalkühlung)	114X0200	114X0201	114X0203	OP-MCGC006FR	FR6GX	G	G	BG2	0,25	1	200	0,8	3/8"	1/4"
MBP (Normalkühlung)	114X2316	114X2317	114X2319	OP-MCHC006FR	FR6DLX	G	H	BG3	0,31	1	230	1,1	3/8"	1/4"
MBP (Normalkühlung)	114X0228			OP-MCGC006NL	NL6.1MF	G	G	BG2	0,25	1	200	0,8	3/8"	1/4"
MBP (Normalkühlung)	114X0216	114X0217	114X0219	OP-MCGC007FR	FR7,5GX	G	G	BG2	0,25	1	200	0,8	3/8"	1/4"
MBP (Normalkühlung)	114X0244			OP-MCGC007NL	NL7.3MF	G	G	BG2	0,25	1	200	0,8	3/8"	1/4"
MBP (Normalkühlung)	114X2424	114X2425	114X2427	OP-MCHB007NF	NF7MLX	G	H	BG4/5	0,4	1	254	1,1	3/8"	1/4"
MBP (Normalkühlung)	114X0224	114X0225	114X0227	OP-MCGC008FR	FR8,5GX	G	G	BG2	0,25	1	200	0,8	3/8"	1/4"
MBP (Normalkühlung)	114X0204	114X0205		OP-MCGC008NL	NL8.4MF	G	G	BG2	0,25	1	200	0,8	3/8"	1/4"
MBP (Normalkühlung)	114X0352			OP-MCGC008NL	NL8.4MF	G	G	BG3	0,31	1	230	-	3/8"	1/4"
MBP (Normalkühlung)			114X0223	OP-MCGC010SC	SC10GX	G	G	BG2	0,25	1	200	0,8	3/8"	1/4"
MBP (Normalkühlung)	114X0403	114X0404	114X0405	OP-MCHC010SC	SC10MLX	G	H	BG4/5	0,4	1	254	1,1	3/8"	1/4"
MBP (Normalkühlung)	114X0336	114X0337	114X0339	OP-MCGC011FR	FR11GX	G	G	BG3	0,31	1	230	1,1	3/8"	1/4"
MBP (Normalkühlung)	114X0340	114X0341	114X0343	OP-MCGC012SC	SC12GX	G	G	BG3	0,31	1	230	1,1	3/8"	1/4"
MBP (Normalkühlung)	114X0406	114X0407	114X0408	OP-MCHC013SC	SC12MLX	G	H	BG4/5	0,4	1	254	1,1	3/8"	1/4"
MBP (Normalkühlung)	114X0448	114X0449	114X0451	OP-MCGC015SC	SC15GX	G	G	BG4/5	0,4	1	254	1,1	3/8"	1/4"
MBP (Normalkühlung)		114X2649	114X2651	OP-MCHC015SC	SC15MLX	G	H	BG6	1,1	1	300	1,1	1/2"	1/4"
MBP (Normalkühlung)	114X0556	114X0557	114X0559	OP-MCGC018SC	SC18G	G	G	BG4/5	0,4	1	254	1,1	3/8"	1/4"
MBP (Normalkühlung)		114X0702	114X0703	OP-MCHC018SC	SC18MLX	G	H	BG7	0,84	1	300	1,1	1/2"	1/4"
MBP (Normalkühlung)	114X0568			OP-MCGC021SC	SC21MF	G	G	BG4/5	0,4	1	254	1,1	3/8"	1/4"
MBP (Normalkühlung)	114X0564	114X0565	114X0567	OP-MCGC021SC	SC21GX	G	G	BG4/5	0,4	1	254	1,1	3/8"	1/4"
MBP (Normalkühlung)		114X2765	114X2767	OP-MCHC021GS	GS21MLX	G	H	BG7	0,84	1	300	1,6	5/8"	3/8"
MBP (Normalkühlung)		114X0773		OP-MCGC026GS	GS26MFX	G	G	BG7	0,84	1	300	2,4	3/8"	1/4"
MBP (Normalkühlung)		114X0781		OP-MCGC034GS	GS34MFX	G	G	BG7	0,84	1	300	2,4	1/2"	3/8"

## Instruktioner

### R290 – Technische Daten

Anwendung	Version			Beschreibung	Verdichter	Spannungscode	Kältemittel	Verflüssiger		Lüfter		Sammlerinhalt (l)	Saugleitung (mm)	Flüssigkeitsleitung (mm)
	A09	A10	A11					Bezeichnung	Innen-volumen (l)	Nummer	Flügel (mm)			
LBP (Tiefkühlung)	114F0202	114F0203	114F0201	OP-LCNC004NU	NUY45LAB	G	N	BG2	0.25	1	200	0.114	6	6
LBP (Tiefkühlung)	114F0205	114F0206	114F0204	OP-LCNC006NU	NUT60CAe	G	N	BG2	0.25	1	200	0.114	6	6
LBP (Tiefkühlung)	114F0308	114F0309	114F0307	OP-LCNC008NU	NUY80LAB	G	N	BG3	0.31	1	230	0.114	6	6
LBP (Tiefkühlung)	114F0411	114F0412	114F0410	OP-LCNC011NY	NPY12LAB	G	N	BG4/5	0.4	1	254	0.165	8	6
LBP (Tiefkühlung)	114F0414	114F0415	114F0413	OP-LCNC016NP	NPT16LA	G	N	BG4/5	0.4	1	254	0.165	8	6
LBP (Tiefkühlung)	114F0417	114F0418	114F0416	OP-LCNC023NX	NX23FBa	G	N	BG4/5	0.4	1	254	0.165	10	6
LBP (Tiefkühlung)	114F0620	114F0621	114F0619	OP-LCNC034NS	NS34FB	G	N	BG6	0.63	1	300	0.32	12	6
MBP (Normalkühlung)	114F1202	114F1203	114F1201	OP-MCNC003NB	NBC30RA	G	N	BG2	0.25	1	200	0.114	6	6
MBP (Normalkühlung)	114F1205	114F1206	114F1204	OP-MCNC004NU	NUY45Rab	G	N	BG2	0.25	1	200	0.114	6	6
MBP (Normalkühlung)	114F1308	114F1309	114F1307	OP-MCNC006NU	NUY60Rab	G	N	BG3	0.31	1	230	0.114	6	6
MBP (Normalkühlung)	114F1411	114F1412	114F1410	OP-MCNC008NU	NUY80Rab	G	N	BG4/5	0.4	1	254	0.165	6	6
MBP (Normalkühlung)	114F1414	114F1415	114F1413	OP-MCNC009NU	NUY90Rab	G	N	BG4/5	0.4	1	254	0.165	6	6
MBP (Normalkühlung)	114F1417	114F1418	114F1416	OP-MCNC011NY	NLY12Rab	G	N	BG4/5	0.4	1	254	0.165	8	6
MBP (Normalkühlung)	114F1420	114F1421	114F1419	OP-MCNC014NP	NPT14RA	G	N	BG4/5	0.4	1	254	0.165	8	6
MBP (Normalkühlung)	114F1623	114F1624	114F1622	OP-MCNC016NP	NPT16RA	G	N	BG6	0.63	1	300	0.32	8	6
MBP (Normalkühlung)	114F1626	114F1627	114F1625	OP-MCNC018NX	NX18TBa	G	N	BG6	0.63	1	300	0.32	10	6
MBP (Normalkühlung)	114F1629	114F1630	114F1628	OP-MCNC020NX	NX21TBa	G	N	BG6	0.63	1	300	0.32	10	6

### Nicht-Katalog – Technische Daten

Anwendung	Version					Verdichter	Kältemittel	Verflüssiger	Lüfter		Sammlerinhalt (l)
	T0	T1	T2	N0	N2				Nummer	Durchmesser (mm)	
LBP (Tiefkühlung)	-	-	-	-	114G1600	TL3F	F	BG2	1	200	0,8
LBP (Tiefkühlung)	-	-	114E2471	114H1506	-	TL4CL	CL	BG1	1	170	0,8
LBP (Tiefkühlung)	-	-	-	114E2123 114E2227	114G1602	TL55F	F	BG1	1	170	0,8
LBP (Tiefkühlung)	-	-	114H2726	114E2454 114E2503	-	FR6CL	CL	BG2	1	200	0,8
LBP (Tiefkühlung)	-	-	-	114G1512	114G1612	NL9F	F	BG2	1	200	0,8
LBP (Tiefkühlung)	-	-	-	-	114G2613	NL11F	F	BG2	1	200	0,8
LBP (Tiefkühlung)	-	-	-	114E2603	-	NL8.4MF	MF	BG2	1	200	0,8
LBP (Tiefkühlung)	-	-	-	114E2577 114H3546	-	NL8.4CLX	CL	BG3	1	230	1,1
LBP (Tiefkühlung)	114E2593	114E2517	114H3728	-	-	FR8.5CL	CL	BG3	1	230	1,1
LBP (Tiefkühlung)	-	114E2156	114H3730	114E2198 114E2452 114E2534	-	SC10CL	CL	BG3	1	230	1,1
LBP (Tiefkühlung)	-	-	-	-	114G1611	NL7F	F	BG4/5	1	254	1,1
LBP (Tiefkühlung)	-	-	114H4731	-	-	SC12CL	CL	BG4/5	1	254	1,1
LBP (Tiefkühlung)	114E2536	-	114H5732	-	114E2361	SC15CL	CL	BG4/5	1	254	1,1
LBP (Tiefkühlung)	114E4007	-	114H5733	114H5533 114E2172	-	SC18CL	CL	BG4/5	1	254	1,1
LBP (Tiefkühlung)	114E2353 114E2555 114E4003	-	-	-	-	SC21CL	CL	BG4/5	1	254	1,1
LBP (Tiefkühlung)	-	-	114H6735 114H6335	-	-	SC10/10CL	CL	BG6	1	300	2,4
LBP (Tiefkühlung)	-	-	114H7736 114H7336 114F5052	-	-	SC12/12CL	CP	BG7	1	300	2,4
LBP (Tiefkühlung)	-	-	114H7337 114F5053 114H7737	-	-	SC15/15CL	CL	BG7	1	300	2,4
LBP (Tiefkühlung)	114E2546	-	114H7338 114H7738	-	-	SC18/18CL	CP	BG7	1	300	2,4
LBP (Tiefkühlung)	-	-	114H7339 114H7739	-	-	SC21/21CL	CP	BG7	1	300	2,4
MBP (Normalkühlung)	-	-	-	114G0503	-	PL35G	G	BG0	1	172	-
MBP (Normalkühlung)	-	-	-	114E2203 114G0502	-	PL50F	F	BG0	1	172	-
MBP (Normalkühlung)	114B0017	-	-	-	-	BD250GH	G	BG0.5	1	172	-
MBP (Normalkühlung)	-	-	114G1706	114G1506	114G1606	TL4G	G	BG1	1	170	0,8
MBP (Normalkühlung)	114E2548	-	114G1708	114E2492 114E2541	-	TL5G	G	BG1	1	170	0,8
MBP (Normalkühlung)	-	-	-	114B0006 114G1901	-	TL4GH	G	BG1	1	170	0,8
MBP (Normalkühlung)	-	-	-	114G2515	114G2615	FR6G	G	BG2	1	200	0,8
MBP (Normalkühlung)	-	-	-	114G2518	-	FR7.5G	G	BG2	1	200	0,8

## Instruktioner

### Nicht-Katalog – Technische Daten (Fortsetzung)

Anwendung	Version					Verdichter	Kältemittel	Verflüssiger	Lüfter		Sammelerinhalt (l)
	T0	T1	T2	N0	N2				Nummer	Durchmesser (mm)	
MBP (Normalkühlung)	114E2346	-	114G2716	114E2201 114E2332 114G2516	114G2616	FR8.5G	G	BG2	1	200	0,8
MBP (Normalkühlung)	114E2410 114E2519 114E2522	-	-	114E2362	-	FR8.5G	G	BG2	1	200	0,8
MBP (Normalkühlung)	-	-	114G2719	-	-	FR10G	G	BG2	1	200	0,8
MBP (Normalkühlung)	114E2347 114E2411 114E2520 114E2544	-	-	114E2333 114E2523	-	SC10G	G	BG2	1	200	0,8
MBP (Normalkühlung)	-	-	114E2527 114H3727	-	-	FR6DL	DL	BG3	1	230	1,1
MBP (Normalkühlung)	-	-	114G3717	114G3517	114G3617	FR11G	G	BG3	1	230	1,1
MBP (Normalkühlung)	-	-	-	114G3536	-	NL10MF	MF	BG3	1	230	1,1
MBP (Normalkühlung)	114E2351 114E2390 114E2549 114E2545 114E2457 114E2521	-	114G3726	114E2434 114G3526 114G9350 114G4565	114G3626	SC12G	G	BG3	1	230	1,1
MBP (Normalkühlung)	-	-	114E2528 114H5743	-	-	SC10DL	DL	BG4/5	1	254	1,1
MBP (Normalkühlung)	-	-	114H5744	-	-	SC12DL	DL	BG4/5	1	254	1,1
MBP (Normalkühlung)	114E2352 114E2391 114E2550	-	114G4727	114E2435 114G4527	114G4627	SC15G	G	BG4/5	1	254	1,1
MBP (Normalkühlung)	114E2442 114E2567 114E4023	-	114G5728	114E2357 114E2418 114G5528	-	SC18G	G	BG4/5	1	254	1,1
MBP (Normalkühlung)	114E2459 114E2551	-	114G5730	114E2419 114G5530	-	SC21G	G	BG4/5	1	254	1,1
MBP (Normalkühlung)	114E2540	-	114E2529 114H6745	-	-	SC15DL	DL	BG6	1	300	2,4
MBP (Normalkühlung)	-	-	114E2586	-	-	SC15MLX	ML	BG6	1	300	2,4
MBP (Normalkühlung)	-	-	114E2587	-	-	SC18MLX	ML	BG7	1	300	2,4
MBP (Normalkühlung)	-	-	114G6380 114G6780	-	-	SC12/12G	G	BG6	1	300	2,4
MBP (Normalkühlung)	-	-	114H7347 114H7747	-	-	SC10/10DL	DL	BG7	1	300	2,4
MBP (Normalkühlung)	-	-	114H7348 114H7748	-	-	SC12/12DL	DL	BG7	1	300	2,4
MBP (Normalkühlung)	-	-	114G7381 114G7781	-	-	SC15/15G	G	BG7	1	300	2,4
MBP (Normalkühlung)	-	-	114H7349 114H7749	-	-	SC15/15DL	DL	BG7	1	300	2,4
MBP (Normalkühlung)	114E2128	-	114G7382 114G7782	-	-	SC18/18G	G	BG7	1	300	2,4
MBP (Normalkühlung)	114E2149	-	114G7383 114G7783	-	-	SC21/21G	G	BG7	1	300	2,4
LBP/MBP	-	-	-	114F1504	-	TL5CN	CN	BG1	1	170	-
LBP/MBP	-	-	-	114F1508	-	TL4CN	CN	BG1	1	170	-
LBP/MBP	-	-	-	114F2505	-	NL7CN	CN	BG2	1	200	-
LBP/MBP	-	-	-	114F3500	-	SC10CN	CN	BG3	1	230	-
LBP/MBP	-	-	-	114F3509	-	NL9CN	CN	BG2	1	200	-
LBP/MBP	-	-	-	114F4501	-	SC12CN	CN	BG4/5	1	254	-
LBP/MBP	-	-	-	114F4502	-	SC15CN	CN	BG4/5	1	254	-
LBP/MBP	-	-	-	114F4503	-	SC18CN	CN	BG4/5	1	254	-

Auf Anfrage Netzkabel zu Nicht-Katalog-Typen hinzugefügt

### UL – Technische Daten

Anwendung	Version				Verdichter	Kältemittel	Verflüssiger	Lüfter		Sammelerinhalt (l)
	T0	T1	T2	N0				Nummer	Durchmesser (mm)	
LBP (Tiefkühlung)	-	-	114G2573	-	NL11F	F	BG2	1	200	0,8
LBP (Tiefkühlung)	114E2403	-	-	-	SC10CLX	CL	BG3	1	230	1,2
LBP (Tiefkühlung)	114H4515	-	114E4018	-	SC12CL	CL	BG4/5	1	254	1,1
LBP (Tiefkühlung)	-	-	-	114H5953	SC18CLX	CL	BG4/5	1	254	1,1
LBP (Tiefkühlung)	-	-	114E2495	-	SC15CLX	CL	BG4/5	1	254	1,1
LBP (Tiefkühlung)	-	-	114E4024	-	SC15CLX	CL	BG4/5	1	254	1,1
LBP (Tiefkühlung)	-	-	-	114F5062	SC12/12CL	CL	BG4/5	1	254	1,1
LBP (Tiefkühlung)	114F0207 114F0208	-	-	-	DLE4.8CN	CN	BG2	1	200	0,8
MBP (Normalkühlung)	114G1900	114G1660	-	114G1760 114G1940	TL4G	G	BG1	1	170	0,8
MBP (Normalkühlung)	-	-	114E4020	-	FF8.5GX	G	BG3	1	230	1,2
MBP (Normalkühlung)	-	-	114E4021	114G3768	FF10GX	G	BG3	1	230	1,2
MBP (Normalkühlung)	114E2397	-	114E4022	114G3942	SC12G	G	BG3	1	230	1,2
MBP (Normalkühlung)	-	-	114E4002	-	SC15G	G	BG4/5	1	254	1,1
MBP (Normalkühlung)	-	-	-	114G5946	SC18GH	G	BG4/5	1	254	1,1

## Instructions

### Annexe - A, Données techniques

#### Étiquette

<b>B</b>	<b>Optyma™</b> by Danfoss	EAN No :			MADE IN ITALY
	<b>C</b>	Serial No 29XXXXXXX			
	Refrigerant: (1) Rxxxx (2)	<b>114X1219</b>	<b>Model: XXXXXXXX</b>	<b>A</b>	<b>D</b>
	Max. Working Pressure HP (1) xx	Comp: xxx- xxxV xxHz Fan: xxx- xxxV xxHz- xxHz Refr. Charge < 150g			
	According with EN 378 and temperature 46°C	If imported from UK - Danfoss Ltd., 22 Wycombe End, HP9 1NB, GB Імпортер: ТОВ з іі "Данфосс ТОВ" 04080, Київ 80, п/с 168, Україна			

**A** : N° de code du groupe de condensation

**B** : Numéro de série de production

**C** : Fluide frigorigène

**D** : Désignation du modèle

**E** : Alimentation électrique du compresseur et du moteur du ventilateur

### Désignation - Catalogue

**OP - LCQN 048 MT A00 E**

OP = Optyma

1 2 3 4 5 6 7 8

1	<b>Application :</b> <b>M</b> = Contre-pression moyenne ; <b>L</b> = Contre-pression basse
2	<b>Plateforme de compresseur :</b> <b>C</b> : Groupe de condensation à refroidissement par air avec un seul ventilateur
3	<b>Fluide frigorigène :</b> <b>G</b> : R134a, R513A ; <b>H</b> : R404A/R507 ; <b>Q</b> : R452A, R404A/R507 ; <b>N</b> : R290
4	<b>Conception du condenseur :</b> <b>C</b> : Condenseur à tubes à ailettes, température ambiante jusqu'à 43 °C
5	<b>Cylindrée du compresseur :</b> Exemple 048 = 48 cm <sup>3</sup>
6	<b>Plateforme de compresseur à piston :</b> FR = FR, NF = NF, SC = SC, GS = GS, NX = NX, NB = NBC, NS = NS, NU = NUY, NP = NPT, MP = MPT, MY = MLY, MX = MX, TL = TL, NL = NL
7	<b>Version :</b> A00, A01, A04, A09, A10, A11. Voir le tableau Vue d'ensemble des caractéristiques pour connaître les caractéristiques accompagnant chaque version.
8	<b>Code tension :</b> <b>G</b> : Compresseur 230 V/monophasé/50 Hz, ventilateur 230 V/monophasé/50 Hz <b>E</b> : Compresseur 400 V/triphasé/50 Hz, ventilateur 230 V/monophasé/50 Hz

	Petit tertiaire			Petit tertiaire R290		
	A00	A01	A04	A09	A10	A11
Température ambiante	Jusqu'à 43 °C			Jusqu'à 43 °C		
Plateforme de compresseur à piston hermétique	MPT, MLY, NL, SC, GS, FR, TL, NF			NUY, NBC, NPT, NS, NX		
Base du groupe	Rails ou socle					
Type de condenseur	À tube à ailettes (peints)					
Ventilateur	CA/EC	CA/EC	CA/EC	EC	EC	EC
Support et tube pour montage du pressostat	-	oui	oui	oui	-	-
Pressostat double - KP 17 WB	-	-	oui	-	-	-
Vanne Schrader	-	-	-	oui	oui	oui
Boîtier électrique câblé	oui	oui	oui	oui	oui	oui
Mini-pressostat HP/BP	-	-	-	-	oui	-
Cordon d'alimentation	-	-	oui	-	oui	-
Réservoir	-	oui	oui	-	Déshydrateur combiné + réservoir	-

**Instructions**

**Désignation - Hors catalogue**

**SC 18 G X T2**

┌
┌
┌┌
┌┌
└  
1
2
3
4
5

1	<b>Plateforme de compresseur :</b> <b>PL, TL, NL, FR, SC, GS</b>
2	<b>Cylindrée du compresseur :</b> Exemple 048 = 48 cm <sup>3</sup>
3	<b>Application et fluide frigorigène :</b> <b>CM</b> = Basses températures ; R22 <b>CL</b> = Basses températures ; R404A/R507 <b>CN</b> = Basses températures/ Moyennes températures ; R290 <b>CP</b> = Basses températures ; R404A/R507, R452A <b>DM</b> = Hautes températures ; R22 <b>DL</b> = Hautes températures ; R404A/R507 <b>F</b> = Basses températures/ (Moyennes températures) ; R134a <b>FT</b> = tropicalisé basses températures ; R134a <b>G</b> = Basses/moyennes/hautes températures ; R134a & R513A <b>GH</b> = optimisé pour pompe à chaleur ; R134a <b>MF</b> = moyennes températures ; R134a <b>ML</b> = moyennes températures ; R404A/507
4	<b>Caractéristiques de démarrage</b> <b>X</b> = HST <b>K</b> = LST
5	<b>Version :</b> N0 - pour tube capillaire - sans vanne d'arrêt, sans réservoir N1 - pour tube capillaire - avec 1 vanne d'arrêt, sans réservoir N2 - pour tube capillaire - avec 2 vannes d'arrêt, sans réservoir T0 - pour détendeur - avec réservoir sans vanne d'arrêt T1 - pour détendeur - avec réservoir avec 1 vanne d'arrêt T2 - pour détendeur - avec réservoir avec 2 vannes d'arrêt

	Petit tertiaire					
	N0	N1	N2	T0	T1	T2
Température ambiante	Jusqu'à 43 °C					
Compresseur à piston hermétique	NL, SC, GS, FR, TL, NF, DL					
Base du groupe	Rails ou socle					
Type de condenseur	À tube à ailettes (peints)					
Vanne Schrader	-	-	-	oui	oui	oui
Boîtier électrique câblé	oui	oui	oui	oui	oui	oui
Vanne de service	-	oui*	oui	-	oui*	oui
Réservoir	-	-	-	oui	oui	oui

\*) 1X Vanne de service

## Instructions

### Modèles catalogue

#### Petit tertiaire - Données techniques

Application	Version			Description	Compresseur	Code électrique	Fluide frigorigène	Batterie du condenseur		Ventilateur		Volume du réservoir (L)	Conduite d'aspiration	Conduite de liquide
	A00	A01	A04					Désignation	Volume interne (L)	Nombre	Pale (mm)			
Basses températures (BT)	114X1208	114X1209	114X1211	OP-LCHC004TL	TL4CL	G	H	BG2	0,25	1	200	0,8	1/4"	1/4"
Basses températures (BT)		114X1221		OP-LCQC004ML	MLY45LAb	G	Qc	BG2	0,25	1	200	0,8	3/8"	1/4"
Basses températures (BT)	114X1216	114X1217	114X1219	OP-LCHC006FR	FR6CL	G	H	BG2	0,25	1	200	0,8	3/8"	1/4"
Basses températures (BT)		114X1337		OP-LCQC006ML	MLY60LAb	G	Qc	BG3	0,31	1	230	1,1	3/8"	1/4"
Basses températures (BT)	114X1328	114X1329	114X1331	OP-LCHC007NL	NL7CLX	G	H	BG3	0,31	1	230	1,1	3/8"	1/4"
Basses températures (BT)	114X1324	114X1325	114X1327	OP-LCHC008FR	FR8.5CL	G	H	BG3	0,31	1	230	1,1	3/8"	1/4"
Basses températures (BT)	114X1304	114X1301	114X1302	OP-LCHC008NL	NL8.4CLX	G	H	BG3	0,31	1	230	1,1	3/8"	1/4"
Basses températures (BT)		114X1341		OP-LCQC008ML	MLY80LAb	G	Qc	BG3	0,31	1	230	1,1	3/8"	1/4"
Basses températures (BT)	114X1440	114X1441	114X1443	OP-LCHC012SC	SC12CL	G	H	BG4/5	0,4	1	254	1,1	3/8"	1/4"
Basses températures (BT)	114X1444			OP-LCHC012SC	SC12CLX.2	G	H	BG4/5	0,4	1	254	1,1	3/8"	1/4"
Basses températures (BT)		114X1449		OP-LCQC012ML	MLY12LAb	G	Qc	BG4/5	0,4	1	254	1,1	3/8"	1/4"
Basses températures (BT)		114X1569		OP-LCQC012MP	MPT12LA	G	Qc	BG4/5	0,4	1	254	1,1	3/8"	1/4"
Basses températures (BT)		114X1573		OP-LCQC014MP	MPT14LA	G	Qc	BG4/5	0,4	1	254	1,1	1/2"	1/4"
Basses températures (BT)	114X1548	114X1549	114X1551	OP-LCHC015SC	SC15CLX	G	H	BG4/5	0,4	1	254	1,1	3/8"	1/4"
Basses températures (BT)	114X1556	114X1557	114X1559	OP-LCHC018SC	SC18CL	G	H	BG4/5	0,4	1	254	1,1	1/2"	1/4"
Basses températures (BT)	114X1600	114X1601	114X1602	OP-LCHC021SC	SC21CL	G	H	BG6	0,63	1	300	1,1	1/2"	1/4"
Basses températures (BT)		114X1673		OP-LCHC026GS	GS26CLX	G	H	BG6	0,63	1	300	2,4	1/2"	3/8"
Basses températures (BT)		114X1781	114X1783	OP-LCHC034GS	GS34CLX	G	H	BG7	0,84	1	300	2,4	1/2"	3/8"
Moyennes températures (MT)	114X0104	114X0105	114X0107	OP-MCGC003TL	TL3GX	G	G	BG1	0,13	1	172	0,8	1/4"	1/4"
Moyennes températures (MT)	114X0108	114X0109	114X0111	OP-MCGC004TL	TL4GX	G	G	BG1	0,13	1	172	0,8	1/4"	1/4"
Moyennes températures (MT)	114X0301	114X0302	114X0303	OP-MCHC004TL	TL4DL	G	H	BG3	0,31	1	230	1,1	3/8"	1/4"
Moyennes températures (MT)	114X0112	114X0113	114X0115	OP-MCGC005TL	TL5GX	G	G	BG1	0,13	1	172	0,8	1/4"	1/4"
Moyennes températures (MT)	114X0200	114X0201	114X0203	OP-MCGC006FR	FR6GX	G	G	BG2	0,25	1	200	0,8	3/8"	1/4"
Moyennes températures (MT)	114X2316	114X2317	114X2319	OP-MCHC006FR	FR6DLX	G	H	BG3	0,31	1	230	1,1	3/8"	1/4"
Moyennes températures (MT)	114X0228			OP-MCGC006NL	NL6.1MF	G	G	BG2	0,25	1	200	0,8	3/8"	1/4"
Moyennes températures (MT)	114X0216	114X0217	114X0219	OP-MCGC007FR	FR7.5GX	G	G	BG2	0,25	1	200	0,8	3/8"	1/4"
Moyennes températures (MT)	114X0244			OP-MCGC007NL	NL7.3MF	G	G	BG2	0,25	1	200	0,8	3/8"	1/4"
Moyennes températures (MT)	114X2424	114X2425	114X2427	OP-MCHB007NF	NF7MLX	G	H	BG4/5	0,4	1	254	1,1	3/8"	1/4"
Moyennes températures (MT)	114X0224	114X0225	114X0227	OP-MCGC008FR	FR8.5GX	G	G	BG2	0,25	1	200	0,8	3/8"	1/4"
Moyennes températures (MT)	114X0204	114X0205		OP-MCGC008NL	NL8.4MF	G	G	BG2	0,25	1	200	0,8	3/8"	1/4"
Moyennes températures (MT)	114X0352			OP-MCGC008NL	NL8.4MF	G	G	BG3	0,31	1	230	-	3/8"	1/4"
Moyennes températures (MT)			114X0223	OP-MCGC010SC	SC10GX	G	G	BG2	0,25	1	200	0,8	3/8"	1/4"
Moyennes températures (MT)	114X0403	114X0404	114X0405	OP-MCHC010SC	SC10MLX	G	H	BG4/5	0,4	1	254	1,1	3/8"	1/4"
Moyennes températures (MT)	114X0336	114X0337	114X0339	OP-MCGC011FR	FR11GX	G	G	BG3	0,31	1	230	1,1	3/8"	1/4"
Moyennes températures (MT)	114X0340	114X0341	114X0343	OP-MCGC012SC	SC12GX	G	G	BG3	0,31	1	230	1,1	3/8"	1/4"
Moyennes températures (MT)	114X0406	114X0407	114X0408	OP-MCHC013SC	SC12MLX	G	H	BG4/5	0,4	1	254	1,1	3/8"	1/4"
Moyennes températures (MT)	114X0448	114X0449	114X0451	OP-MCGC015SC	SC15GX	G	G	BG4/5	0,4	1	254	1,1	3/8"	1/4"
Moyennes températures (MT)		114X2649	114X2651	OP-MCHC015SC	SC15MLX	G	H	BG6	1,1	1	300	1,1	1/2"	1/4"
Moyennes températures (MT)	114X0556	114X0557	114X0559	OP-MCGC018SC	SC18G	G	G	BG4/5	0,4	1	254	1,1	3/8"	1/4"
Moyennes températures (MT)		114X0702	114X0703	OP-MCHC018SC	SC18MLX	G	H	BG7	0,84	1	300	1,1	1/2"	1/4"
Moyennes températures (MT)	114X0568			OP-MCGC021SC	SC21MF	G	G	BG4/5	0,4	1	254	1,1	3/8"	1/4"
Moyennes températures (MT)	114X0564	114X0565	114X0567	OP-MCGC021SC	SC21GX	G	G	BG4/5	0,4	1	254	1,1	3/8"	1/4"
Moyennes températures (MT)		114X2765	114X2767	OP-MCHC021GS	GS21MLX	G	H	BG7	0,84	1	300	1,6	5/8"	3/8"
Moyennes températures (MT)		114X0773		OP-MCGC026GS	GS26MFX	G	G	BG7	0,84	1	300	2,4	3/8"	1/4"
Moyennes températures (MT)		114X0781		OP-MCGC034GS	GS34MFX	G	G	BG7	0,84	1	300	2,4	1/2"	3/8"

## Instructions

### R290 - Données techniques

Application	Version			Description	Compresseur	Code électrique	Fluide frigorigène	Batterie du condenseur		Ventilateur		Volume du réservoir (L)	Conduite d'aspiration (mm)	Conduite de liquide (mm)
	A09	A10	A11					Désignation	Volume interne (L)	Nombre	Pale (mm)			
Basses températures (BT)	114F0202	114F0203	114F0201	OP-LCNC004NU	NUY45Lab	G	N	BG2	0,25	1	200	0,114	6	6
Basses températures (BT)	114F0205	114F0206	114F0204	OP-LCNC006NU	NUT60CAe	G	N	BG2	0,25	1	200	0,114	6	6
Basses températures (BT)	114F0308	114F0309	114F0307	OP-LCNC008NU	NUY80Lab	G	N	BG3	0,31	1	230	0,114	6	6
Basses températures (BT)	114F0411	114F0412	114F0410	OP-LCNC011NY	NPY12Lab	G	N	BG4/5	0,4	1	254	0,165	8	6
Basses températures (BT)	114F0414	114F0415	114F0413	OP-LCNC016NP	NPT16LA	G	N	BG4/5	0,4	1	254	0,165	8	6
Basses températures (BT)	114F0417	114F0418	114F0416	OP-LCNC023NX	NX23FBa	G	N	BG4/5	0,4	1	254	0,165	10	6
Basses températures (BT)	114F0620	114F0621	114F0619	OP-LCNC034NS	NS34FB	G	N	BG6	0,63	1	300	0,32	12	6
Moyennes températures (MT)	114F1202	114F1203	114F1201	OP-MCNC003NB	NBC30RA	G	N	BG2	0,25	1	200	0,114	6	6
Moyennes températures (MT)	114F1205	114F1206	114F1204	OP-MCNC004NU	NUY45Rab	G	N	BG2	0,25	1	200	0,114	6	6
Moyennes températures (MT)	114F1308	114F1309	114F1307	OP-MCNC006NU	NUY60Rab	G	N	BG3	0,31	1	230	0,114	6	6
Moyennes températures (MT)	114F1411	114F1412	114F1410	OP-MCNC008NU	NUY80Rab	G	N	BG4/5	0,4	1	254	0,165	6	6
Moyennes températures (MT)	114F1414	114F1415	114F1413	OP-MCNC009NU	NUY90Rab	G	N	BG4/5	0,4	1	254	0,165	6	6
Moyennes températures (MT)	114F1417	114F1418	114F1416	OP-MCNC011NY	NLY12Rab	G	N	BG4/5	0,4	1	254	0,165	8	6
Moyennes températures (MT)	114F1420	114F1421	114F1419	OP-MCNC014NP	NPT14RA	G	N	BG4/5	0,4	1	254	0,165	8	6
Moyennes températures (MT)	114F1623	114F1624	114F1622	OP-MCNC016NP	NPT16RA	G	N	BG6	0,63	1	300	0,32	8	6
Moyennes températures (MT)	114F1626	114F1627	114F1625	OP-MCNC018NX	NX18TBa	G	N	BG6	0,63	1	300	0,32	10	6
Moyennes températures (MT)	114F1629	114F1630	114F1628	OP-MCNC020NX	NX21TBa	G	N	BG6	0,63	1	300	0,32	10	6

### Hors catalogue - Données techniques

Application	Version					Compresseur	Fluide frigorigène	Condenseur	Ventilateur		Volume du réservoir (L)	
	T0	T1	T2	N0	N2				Nombre	Diamètre (mm)		
Basses températures (BT)	-	-	-	-	-	114G1600	TL3F	F	BG2	1	200	0,8
Basses températures (BT)	-	-	114E2471	114H1506	-	-	TL4CL	CL	BG1	1	170	0,8
Basses températures (BT)	-	-	-	114E2123 114E2227	114G1602	-	TLS5F	F	BG1	1	170	0,8
Basses températures (BT)	-	-	114H2726	114E2454 114E2503	-	-	FR6CL	CL	BG2	1	200	0,8
Basses températures (BT)	-	-	-	114G1512	114G1612	-	NL9F	F	BG2	1	200	0,8
Basses températures (BT)	-	-	-	-	114G2613	-	NL11F	F	BG2	1	200	0,8
Basses températures (BT)	-	-	-	114E2603	-	-	NL8.4MF	MF	BG2	1	200	0,8
Basses températures (BT)	-	-	-	114E2577 114H3546	-	-	NL8.4CLX	CL	BG3	1	230	1,1
Basses températures (BT)	114E2593	114E2517	114H3728	-	-	-	FR8.5CL	CL	BG3	1	230	1,1
Basses températures (BT)	-	114E2156	114H3730	114E2198 114E2452 114E2534	-	-	SC10CL	CL	BG3	1	230	1,1
Basses températures (BT)	-	-	-	-	114G1611	-	NL7F	F	BG4/5	1	254	1,1
Basses températures (BT)	-	-	114H4731	-	-	-	SC12CL	CL	BG4/5	1	254	1,1
Basses températures (BT)	114E2536	-	114H5732	-	114E2361	-	SC15CL	CL	BG4/5	1	254	1,1
Basses températures (BT)	114E4007	-	114H5733	114H5533 114E2172	-	-	SC18CL	CL	BG4/5	1	254	1,1
Basses températures (BT)	114E2353 114E2555 114E4003	-	-	-	-	-	SC21CL	CL	BG4/5	1	254	1,1
Basses températures (BT)	-	-	114H6735 114H6335	-	-	-	SC10/10CL	CL	BG6	1	300	2,4
Basses températures (BT)	-	-	114H7736 114H7336 114F5052	-	-	-	SC12/12CL	CP	BG7	1	300	2,4
Basses températures (BT)	-	-	114H7337 114F5053 114H7737	-	-	-	SC15/15CL	CL	BG7	1	300	2,4
Basses températures (BT)	114E2546	-	114H7338 114H7738	-	-	-	SC18/18CL	CP	BG7	1	300	2,4
Basses températures (BT)	-	-	114H7339 114H7739	-	-	-	SC21/21CL	CP	BG7	1	300	2,4
Moyennes températures (MT)	-	-	-	114G0503	-	-	PL35G	G	BG0	1	172	-
Moyennes températures (MT)	-	-	-	114E2203 114G0502	-	-	PL50F	F	BG0	1	172	-
Moyennes températures (MT)	114B0017	-	-	-	-	-	BD250GH	G	BG0.5	1	172	-
Moyennes températures (MT)	-	-	114G1706	114G1506	114G1606	-	TL4G	G	BG1	1	170	0,8
Moyennes températures (MT)	114E2548	-	114G1708	114E2492 114E2541	-	-	TL5G	G	BG1	1	170	0,8
Moyennes températures (MT)	-	-	-	114B0006 114G1901	-	-	TL4GH	G	BG1	1	170	0,8
Moyennes températures (MT)	-	-	-	114G2515	114G2615	-	FR6G	G	BG2	1	200	0,8
Moyennes températures (MT)	-	-	-	114G2518	-	-	FR7.5G	G	BG2	1	200	0,8
Moyennes températures (MT)	114E2346	-	114G2716	114E2201 114E2332 114G2516	114G2616	-	FR8.5G	G	BG2	1	200	0,8
Moyennes températures (MT)	114E2410 114E2519 114E2522	-	-	114E2362	-	-	FR8.5G	G	BG2	1	200	0,8
Moyennes températures (MT)	-	-	114G2719	-	-	-	FR10G	G	BG2	1	200	0,8

## Instructions

### Hors catalogue - Données techniques (suite)

Application	Version					Compresseur	Fluide frigorigène	Condenseur	Ventilateur		Volume du réservoir (L)
	T0	T1	T2	N0	N2				Nombre	Diamètre (mm)	
Moyennes températures (MT)	114E2347 114E2411 114E2520 114E2544	-	-	114E2333 114E2523	-	SC10G	G	BG2	1	200	0,8
Moyennes températures (MT)	-	-	114E2527 114H3727	-	-	FR6DL	DL	BG3	1	230	1,1
Moyennes températures (MT)	-	-	114G3717	114G3517	114G3617	FR11G	G	BG3	1	230	1,1
Moyennes températures (MT)	-	-	-	114G3536	-	NL10MF	MF	BG3	1	230	1,1
Moyennes températures (MT)	114E2351 114E2390 114E2549 114E2545 114E2457 114E2521	-	114G3726	114E2434 114G3526 114G9350 114G4565	114G3626	SC12G	G	BG3	1	230	1,1
Moyennes températures (MT)	-	-	114E2528 114H5743	-	-	SC10DL	DL	BG4/5	1	254	1,1
Moyennes températures (MT)	-	-	114H5744	-	-	SC12DL	DL	BG4/5	1	254	1,1
Moyennes températures (MT)	114E2352 114E2391 114E2550	-	114G4727	114E2435 114G4527	114G4627	SC15G	G	BG4/5	1	254	1,1
Moyennes températures (MT)	114E2442 114E2567 114E4023	-	114G5728	114E2357 114E2418 114G5528	-	SC18G	G	BG4/5	1	254	1,1
Moyennes températures (MT)	114E2459 114E2551	-	114G5730	114E2419 114G5530	-	SC21G	G	BG4/5	1	254	1,1
Moyennes températures (MT)	114E2540	-	114E2529 114H6745	-	-	SC15DL	DL	BG6	1	300	2,4
Moyennes températures (MT)	-	-	114E2586	-	-	SC15MLX	ML	BG6	1	300	2,4
Moyennes températures (MT)	-	-	114E2587	-	-	SC18MLX	ML	BG7	1	300	2,4
Moyennes températures (MT)	-	-	114G6380 114G6780	-	-	SC12/12G	G	BG6	1	300	2,4
Moyennes températures (MT)	-	-	114H7347 114H7747	-	-	SC10/10DL	DL	BG7	1	300	2,4
Moyennes températures (MT)	-	-	114H7348 114H7748	-	-	SC12/12DL	DL	BG7	1	300	2,4
Moyennes températures (MT)	-	-	114G7381 114G7781	-	-	SC15/15G	G	BG7	1	300	2,4
Moyennes températures (MT)	-	-	114H7349 114H7749	-	-	SC15/15DL	DL	BG7	1	300	2,4
Moyennes températures (MT)	114E2128	-	114G7382 114G7782	-	-	SC18/18G	G	BG7	1	300	2,4
Moyennes températures (MT)	114E2149	-	114G7383 114G7783	-	-	SC21/21G	G	BG7	1	300	2,4
Basses/moyennes températures	-	-	-	114F1504	-	TL5CN	CN	BG1	1	170	-
Basses/moyennes températures	-	-	-	114F1508	-	TL4CN	CN	BG1	1	170	-
Basses/moyennes températures	-	-	-	114F2505	-	NL7CN	CN	BG2	1	200	-
Basses/moyennes températures	-	-	-	114F3500	-	SC10CN	CN	BG3	1	230	-
Basses/moyennes températures	-	-	-	114F3509	-	NL9CN	CN	BG2	1	200	-
Basses/moyennes températures	-	-	-	114F4501	-	SC12CN	CN	BG4/5	1	254	-
Basses/moyennes températures	-	-	-	114F4502	-	SC15CN	CN	BG4/5	1	254	-
Basses/moyennes températures	-	-	-	114F4503	-	SC18CN	CN	BG4/5	1	254	-

Sur demande, cordon d'alimentation ajouté aux modèles hors catalogue

### UL - Données techniques

Application	Version				Compresseur	Fluide frigorigène	Condenseur	Ventilateur		Volume du réservoir (L)
	T0	T1	T2	N0				Nombre	Diamètre (mm)	
Basses températures (BT)			114G2573		NL11F	F	BG2	1	200	0,8
Basses températures (BT)	114E2403				SC10CLX	CL	BG3	1	230	1,2
Basses températures (BT)	114H4515		114E4018		SC12CL	CL	BG4/5	1	254	1,1
Basses températures (BT)				114H5953	SC18CLX	CL	BG4/5	1	254	1,1
Basses températures (BT)			114E2495		SC15CLX	CL	BG4/5	1	254	1,1
Basses températures (BT)			114E4024		SC15CLX	CL	BG4/5	1	254	1,1
Basses températures (BT)				114F5062	SC12/12CL	CL	BG4/5	1	254	1,1
Basses températures (BT)	114F0207 114F0208				DLE4.8CN	CN	BG2	1	200	0,8
Moyennes températures (MT)	114G1900	114G1660		114G1760 114G1940	TL4G	G	BG1	1	170	0,8
Moyennes températures (MT)			114E4020		FF8.5GX	G	BG3	1	230	1,2
Moyennes températures (MT)			114E4021	114G3768	FF10GX	G	BG3	1	230	1,2
Moyennes températures (MT)	114E2397		114E4022	114G3942	SC12G	G	BG3	1	230	1,2
Moyennes températures (MT)			114E4002		SC15G	G	BG4/5	1	254	1,1
Moyennes températures (MT)				114G5946	SC18GH	G	BG4/5	1	254	1,1



## Instrucciones

### Anexo A, Datos técnicos

#### Información de la etiqueta

<b>B</b>	<b>Optyma™</b> by Danfoss	EAN No :			<b>A</b>
	Serial No 29XXXXXXX			MADE IN ITALY	
<b>C</b>	Refrigerant: (1) Rxxxx (2)		<b>114X1219</b>	<b>Model: XXXXXXXX</b>	<b>D</b>
	Max. Working Pressure HP (1) xx		Comp: xxx-xxxV xxHz Fan: xxx-xxxV xxHz-xxHz Refr. Charge < 150g		<b>E</b>
	According with EN 378 and temperature 46°C		If imported from UK - Danfoss Ltd., 22 Wycombe End, HP9 1NB, GB Імпортёр: ТОВ з іі "Данфосс ТОВ" 04080, Київ 80, п/с 168, Україна		

**A:** Código de la unidad condensadora

**B:** Número de serie de producción

**C:** Refrigerante

**D:** Denominación del modelo

**E:** Fuente de alimentación para el motor del compresor y del ventilador

### Designación - Catálogo

**OP - LCQN 048 MT A00 E**

OP = Optyma

1 2 3 4 5 6 7 8

1	<b>Aplicación:</b> M = contrapresión media; L = contrapresión baja
2	<b>Plataforma del compresor:</b> C: Unidad condensadora refrigerada por aire con un ventilador
3	<b>Refrigerante:</b> G: R134a, R513A; H: R404A/R507; Q: R452A, R404A/R507; N: R290
4	<b>Diseño del condensador:</b> C: Condensador de tubo y aletas, temperatura ambiente de hasta 43 °C
5	<b>Desplazamiento del compresor:</b> Ejemplo 048 = 48 cm³
6	<b>Plataforma de compresores alternativos:</b> FR = FR, NF = NF, SC = SC, GS = GS, NX = NX, NB = NBC, NS = NS, NU = NU, NP = NPT, MP = MPT, MY = MLY, MX = MX, TL = TL, NL = NL
7	<b>Versión:</b> A00, A01, A04, A09, A10, A11. Consulte la tabla de la vista general de características para ver las características de cada versión.
8	<b>Código eléctrico:</b> G: Compresor de 230 V / monofásico / 50 Hz, ventilador de 230 V / monofásico / 50 Hz E: Compresor de 400 V / trifásico / 50 Hz, ventilador de 230 V / monofásico / 50 Hz

	Light Commercial			Light Commercial R290		
	A00	A01	A04	A09	A10	A11
Temperatura ambiente	Hasta 43 °C			Hasta 43 °C		
Plataforma de compresor alternativo hermético	MPT, MLY, NL, SC, GS, FR, TL, NF			NUY, NBC, NPT, NS, NX		
Unidad base	Raíles o placas base					
Tipo de condensador	Tubo y aleta (pintado)					
Ventilador	AC/EC	AC/EC	AC/EC	EC	EC	EC
Soporte y tubo para montaje del presostato	-	sí	sí	sí	-	-
Presostato doble - KP 17 WB	-	-	sí	-	-	-
Válvula Schrader	-	-	-	sí	sí	sí
Caja de conexiones eléctricas cableada	sí	sí	sí	sí	sí	sí
Minipresostato de HP/LP	-	-	-	-	sí	-
Cable de alimentación	-	-	sí	-	sí	-
Recipiente	-	sí	sí	-	Secador combinado + recipiente	-

## Instrucciones

### Designación - Sin catálogo

#### SC 18 G X T2

T T T T T  
1 2 3 4 5

1	<b>Plataforma del compresor:</b> PL, TL, NL, FR, SC, GS
2	<b>Desplazamiento del compresor:</b> Ejemplo 048 = 48 cm <sup>3</sup>
3	<b>Aplicación y refrigerante:</b> <b>CM</b> = LBP; R22 <b>CL</b> = LBP; R404A/R507 <b>CN</b> = LBP/MBP; R290 <b>CP</b> = LBP; R404A/R507, R452A <b>DM</b> = HBP; R22 <b>DL</b> = HBP; R404A/R507 <b>F</b> = LBP/(MBP); R134a <b>FT</b> = LBP tropical; R134a <b>G</b> = LBP/MBP/HBP; R134a y R513A <b>GH</b> = Bomba de calor optimizada; R134a <b>MF</b> = MBP; R134a <b>ML</b> = MBP; R404A/507
4	<b>Características de inicio:</b> <b>X</b> = HST <b>K</b> = LST
5	<b>Versión:</b> N0 - Para tubo capilar - sin válvulas de cierre, sin recipiente N1 - Para tubo capilar - con 1 válvula de cierre, sin recipiente N2 - Para tubo capilar - con 2 válvulas de cierre, sin recipiente T0 - Para válvula de expansión - con recipiente y sin 2 válvulas de cierre T1 - Para válvula de expansión - con recipiente y 1 válvula de cierre T2 - Para válvula de expansión - con recipiente y 2 válvulas de cierre

	Light Commercial					
	N0	N1	N2	T0	T1	T2
Temperatura ambiente	Hasta 43 °C					
Compresor alternativo hermético	NL, SC, GS, FR, TL, NF, DL					
Unidad base	Raíles o placas base					
Tipo de condensador	Tubo y aleta (pintado)					
Válvula Schrader	-	-	-	sí	sí	sí
Caja de conexiones eléctricas cableada	sí	sí	sí	sí	sí	sí
Válvula de servicio	-	sí*	sí	-	sí*	sí
Recipiente	-	-	-	sí	sí	sí

\*) 1 válvula de servicio

## Instrucciones

### Modelos de catálogo

#### Light Commercial - Datos técnicos

Aplicación	Versión			Descripción	Compresor	Código eléctrico	Refrigerante	Bobina del condensador		Ventilador		Volumen del recipiente (l)	Línea de aspiración	Línea de líquido
	A00	A01	A04					Denominación	Volumen interno (l)	Cantidad	Aspa (mm)			
LBP	114X1208	114X1209	114X1211	OP-LCHC004TL	TL4CL	G	H	BG2	0,25	1	200	0,8	1/4"	1/4"
LBP		114X1221		OP-LCQC004ML	MLY45LAB	G	Q	BG2	0,25	1	200	0,8	3/8"	1/4"
LBP	114X1216	114X1217	114X1219	OP-LCHC006FR	FR6CL	G	H	BG2	0,25	1	200	0,8	3/8"	1/4"
LBP		114X1337		OP-LCQC006ML	MLY60LAB	G	Q	BG3	0,31	1	230	1,1	3/8"	1/4"
LBP	114X1328	114X1329	114X1331	OP-LCHC007NL	NL7CLX	G	H	BG3	0,31	1	230	1,1	3/8"	1/4"
LBP	114X1324	114X1325	114X1327	OP-LCHC008FR	FR8.5CL	G	H	BG3	0,31	1	230	1,1	3/8"	1/4"
LBP	114X1304	114X1301	114X1302	OP-LCHC008NL	NL8.4CLX	G	H	BG3	0,31	1	230	1,1	3/8"	1/4"
LBP		114X1341		OP-LCQC008ML	MLY80LAB	G	Q	BG3	0,31	1	230	1,1	3/8"	1/4"
LBP	114X1440	114X1441	114X1443	OP-LCHC012SC	SC12CL	G	H	BG4/5	0,4	1	254	1,1	3/8"	1/4"
LBP	114X1444			OP-LCHC012SC	SC12CLX.2	G	H	BG4/5	0,4	1	254	1,1	3/8"	1/4"
LBP		114X1449		OP-LCQC012ML	MLY12LAB	G	Q	BG4/5	0,4	1	254	1,1	3/8"	1/4"
LBP		114X1569		OP-LCQC012MP	MPT12LA	G	Q	BG4/5	0,4	1	254	1,1	3/8"	1/4"
LBP		114X1573		OP-LCQC014MP	MPT14LA	G	Q	BG4/5	0,4	1	254	1,1	1/2"	1/4"
LBP	114X1548	114X1549	114X1551	OP-LCHC015SC	SC15CLX	G	H	BG4/5	0,4	1	254	1,1	3/8"	1/4"
LBP	114X1556	114X1557	114X1559	OP-LCHC018SC	SC18CL	G	H	BG4/5	0,4	1	254	1,1	1/2"	1/4"
LBP	114X1600	114X1601	114X1602	OP-LCHC021SC	SC21CL	G	H	BG6	0,63	1	300	1,1	1/2"	1/4"
LBP		114X1673		OP-LCHC026GS	GS26CLX	G	H	BG6	0,63	1	300	2,4	1/2"	3/8"
LBP		114X1781	114X1783	OP-LCHC034GS	GS34CLX	G	H	BG7	0,84	1	300	2,4	1/2"	3/8"
MBP	114X0104	114X0105	114X0107	OP-MCGC003TL	TL3GX	G	G	BG1	0,13	1	172	0,8	1/4"	1/4"
MBP	114X0108	114X0109	114X0111	OP-MCGC004TL	TL4GX	G	G	BG1	0,13	1	172	0,8	1/4"	1/4"
MBP	114X0301	114X0302	114X0303	OP-MCHC004TL	TL4DL	G	H	BG3	0,31	1	230	1,1	3/8"	1/4"
MBP	114X0112	114X0113	114X0115	OP-MCGC005TL	TL5GX	G	G	BG1	0,13	1	172	0,8	1/4"	1/4"
MBP	114X0200	114X0201	114X0203	OP-MCGC006FR	FR6GX	G	G	BG2	0,25	1	200	0,8	3/8"	1/4"
MBP	114X2316	114X2317	114X2319	OP-MCHC006FR	FR6DLX	G	H	BG3	0,31	1	230	1,1	3/8"	1/4"
MBP	114X0228			OP-MCGC006NL	NL6.1MF	G	G	BG2	0,25	1	200	0,8	3/8"	1/4"
MBP	114X0216	114X0217	114X0219	OP-MCGC007FR	FR7.5GX	G	G	BG2	0,25	1	200	0,8	3/8"	1/4"
MBP	114X0244			OP-MCGC007NL	NL7.3MF	G	G	BG2	0,25	1	200	0,8	3/8"	1/4"
MBP	114X2424	114X2425	114X2427	OP-MCHB007NF	NF7MLX	G	H	BG4/5	0,4	1	254	1,1	3/8"	1/4"
MBP	114X0224	114X0225	114X0227	OP-MCGC008FR	FR8.5GX	G	G	BG2	0,25	1	200	0,8	3/8"	1/4"
MBP	114X0204	114X0205		OP-MCGC008NL	NL8.4MF	G	G	BG2	0,25	1	200	0,8	3/8"	1/4"
MBP	114X0352			OP-MCGC008NL	NL8.4MF	G	G	BG3	0,31	1	230	-	3/8"	1/4"
MBP			114X0223	OP-MCGC010SC	SC10GX	G	G	BG2	0,25	1	200	0,8	3/8"	1/4"
MBP	114X0403	114X0404	114X0405	OP-MCHC010SC	SC10MLX	G	H	BG4/5	0,4	1	254	1,1	3/8"	1/4"
MBP	114X0336	114X0337	114X0339	OP-MCGC011FR	FR11GX	G	G	BG3	0,31	1	230	1,1	3/8"	1/4"
MBP	114X0340	114X0341	114X0343	OP-MCGC012SC	SC12GX	G	G	BG3	0,31	1	230	1,1	3/8"	1/4"
MBP	114X0406	114X0407	114X0408	OP-MCHC013SC	SC12MLX	G	H	BG4/5	0,4	1	254	1,1	3/8"	1/4"
MBP	114X0448	114X0449	114X0451	OP-MCGC015SC	SC15GX	G	G	BG4/5	0,4	1	254	1,1	3/8"	1/4"
MBP		114X2649	114X2651	OP-MCHC015SC	SC15MLX	G	H	BG6	1,1	1	300	1,1	1/2"	1/4"
MBP	114X0556	114X0557	114X0559	OP-MCGC018SC	SC18G	G	G	BG4/5	0,4	1	254	1,1	3/8"	1/4"
MBP		114X0702	114X0703	OP-MCHC018SC	SC18MLX	G	H	BG7	0,84	1	300	1,1	1/2"	1/4"
MBP	114X0568			OP-MCGC021SC	SC21MF	G	G	BG4/5	0,4	1	254	1,1	3/8"	1/4"
MBP	114X0564	114X0565	114X0567	OP-MCGC021SC	SC21GX	G	G	BG4/5	0,4	1	254	1,1	3/8"	1/4"
MBP		114X2765	114X2767	OP-MCHC021GS	GS21MLX	G	H	BG7	0,84	1	300	1,6	5/8"	3/8"
MBP		114X0773		OP-MCGC026GS	GS26MFX	G	G	BG7	0,84	1	300	2,4	3/8"	1/4"
MBP		114X0781		OP-MCGC034GS	GS34MFX	G	G	BG7	0,84	1	300	2,4	1/2"	3/8"

## Instrucciones

### R290 - Datos técnicos

Aplicación	Versión			Descripción	Compresor	Código eléctrico	Refrigerante	Bobina del condensador		Ventilador		Volumen del recipiente (l)	Línea de aspiración (mm)	Línea de líquido (mm)
	A09	A10	A11					Denominación	Volumen interno (l)	Cantidad	Aspa (mm)			
LBP	114F0202	114F0203	114F0201	OP-LCNC004NU	NUY45LAb	G	N	BG2	0,25	1	200	0,114	6	6
LBP	114F0205	114F0206	114F0204	OP-LCNC006NU	NUT60CAe	G	N	BG2	0,25	1	200	0,114	6	6
LBP	114F0308	114F0309	114F0307	OP-LCNC008NU	NUY80LAb	G	N	BG3	0,31	1	230	0,114	6	6
LBP	114F0411	114F0412	114F0410	OP-LCNC011NY	NPY12LAb	G	N	BG4/5	0,4	1	254	0,165	8	6
LBP	114F0414	114F0415	114F0413	OP-LCNC016NP	NPT16LA	G	N	BG4/5	0,4	1	254	0,165	8	6
LBP	114F0417	114F0418	114F0416	OP-LCNC023NX	NX23FBa	G	N	BG4/5	0,4	1	254	0,165	10	6
LBP	114F0620	114F0621	114F0619	OP-LCNC034NS	NS34FB	G	N	BG6	0,63	1	300	0,32	12	6
MBP	114F1202	114F1203	114F1201	OP-MCNC003NB	NBC30RA	G	N	BG2	0,25	1	200	0,114	6	6
MBP	114F1205	114F1206	114F1204	OP-MCNC004NU	NUY45RAb	G	N	BG2	0,25	1	200	0,114	6	6
MBP	114F1308	114F1309	114F1307	OP-MCNC006NU	NUY60RAb	G	N	BG3	0,31	1	230	0,114	6	6
MBP	114F1411	114F1412	114F1410	OP-MCNC008NU	NUY80RAb	G	N	BG4/5	0,4	1	254	0,165	6	6
MBP	114F1414	114F1415	114F1413	OP-MCNC009NU	NUY90RAb	G	N	BG4/5	0,4	1	254	0,165	6	6
MBP	114F1417	114F1418	114F1416	OP-MCNC011NY	NLY12RAb	G	N	BG4/5	0,4	1	254	0,165	8	6
MBP	114F1420	114F1421	114F1419	OP-MCNC014NP	NPT14RA	G	N	BG4/5	0,4	1	254	0,165	8	6
MBP	114F1623	114F1624	114F1622	OP-MCNC016NP	NPT16RA	G	N	BG6	0,63	1	300	0,32	8	6
MBP	114F1626	114F1627	114F1625	OP-MCNC018NX	NX18TBa	G	N	BG6	0,63	1	300	0,32	10	6
MBP	114F1629	114F1630	114F1628	OP-MCNC020NX	NX21TBa	G	N	BG6	0,63	1	300	0,32	10	6

### Sin catálogo - Datos técnicos

Aplicación	Versión					Compresor	Refrigerante	Condensador	Ventilador		Volumen del recipiente (l)
	T0	T1	T2	N0	N2				Cantidad	Diámetro (mm)	
LBP	-	-	-	-	114G1600	TL3F	F	BG2	1	200	0,8
LBP	-	-	114E2471	114H1506	-	TL4CL	CL	BG1	1	170	0,8
LBP	-	-	-	114E2123 114E2227	114G1602	TLS5F	F	BG1	1	170	0,8
LBP	-	-	114H2726	114E2454 114E2503	-	FR6CL	CL	BG2	1	200	0,8
LBP	-	-	-	114G1512	114G1612	NL9F	F	BG2	1	200	0,8
LBP	-	-	-	-	114G2613	NL11F	F	BG2	1	200	0,8
LBP	-	-	-	114E2603	-	NL8.4MF	MF	BG2	1	200	0,8
LBP	-	-	-	114E2577 114H3546	-	NL8.4CLX	CL	BG3	1	230	1,1
LBP	114E2593	114E2517	114H3728	-	-	FR8.5CL	CL	BG3	1	230	1,1
LBP	-	114E2156	114H3730	114E2198 114E2452 114E2534	-	SC10CL	CL	BG3	1	230	1,1
LBP	-	-	-	-	114G1611	NL7F	F	BG4/5	1	254	1,1
LBP	-	-	114H4731	-	-	SC12CL	CL	BG4/5	1	254	1,1
LBP	114E2536	-	114H5732	-	114E2361	SC15CL	CL	BG4/5	1	254	1,1
LBP	114E4007	-	114H5733	114H5533 114E2172	-	SC18CL	CL	BG4/5	1	254	1,1
LBP	114E2353 114E2555 114E4003	-	-	-	-	SC21CL	CL	BG4/5	1	254	1,1
LBP	-	-	114H6735 114H6335	-	-	SC10/10CL	CL	BG6	1	300	2,4
LBP	-	-	114H7736 114H7336 114F5052	-	-	SC12/12CL	CP	BG7	1	300	2,4
LBP	-	-	114H7337 114F5053 114H7737	-	-	SC15/15CL	CL	BG7	1	300	2,4
LBP	114E2546	-	114H7338 114H7738	-	-	SC18/18CL	CP	BG7	1	300	2,4
LBP	-	-	114H7339 114H7739	-	-	SC21/21CL	CP	BG7	1	300	2,4
MBP	-	-	-	114G0503	-	PL35G	G	BG0	1	172	-
MBP	-	-	-	114E2203 114G0502	-	PL50F	F	BG0	1	172	-
MBP	114B0017	-	-	-	-	BD250GH	G	BG0.5	1	172	-
MBP	-	-	114G1706	114G1506	114G1606	TL4G	G	BG1	1	170	0,8
MBP	114E2548	-	114G1708	114E2492 114E2541	-	TL5G	G	BG1	1	170	0,8
MBP	-	-	-	114B0006 114G1901	-	TL4GH	G	BG1	1	170	0,8
MBP	-	-	-	114G2515	114G2615	FR6G	G	BG2	1	200	0,8
MBP	-	-	-	114G2518	-	FR7.5G	G	BG2	1	200	0,8
MBP	114E2346	-	114G2716	114E2201 114E2332 114G2516	114G2616	FR8.5G	G	BG2	1	200	0,8
MBP	114E2410 114E2519 114E2522	-	-	114E2362	-	FR8.5G	G	BG2	1	200	0,8

## Instrucciones

### Sin catálogo - Datos técnicos (continuación)

Aplicación	Versión					Compresor	Refrigerante	Condensador	Ventilador		Volumen del recipiente (l)
	T0	T1	T2	N0	N2				Cantidad	Diámetro (mm)	
MBP		-	114G2719	-	-	FR10G	G	BG2	1	200	0,8
MBP	114E2347 114E2411 114E2520 114E2544	-	-	114E2333 114E2523	-	SC10G	G	BG2	1	200	0,8
MBP	-	-	114E2527 114H3727	-	-	FR6DL	DL	BG3	1	230	1,1
MBP	-	-	114G3717	114G3517	114G3617	FR11G	G	BG3	1	230	1,1
MBP	-	-	-	114G3536	-	NL10MF	MF	BG3	1	230	1,1
MBP	114E2351 114E2390 114E2549 114E2545 114E2457 114E2521	-	114G3726	114E2434 114G3526 114G9350 114G4565	114G3626	SC12G	G	BG3	1	230	1,1
MBP	-	-	114E2528 114H5743	-	-	SC10DL	DL	BG4/5	1	254	1,1
MBP	-	-	114H5744	-	-	SC12DL	DL	BG4/5	1	254	1,1
MBP	114E2352 114E2391 114E2550	-	114G4727	114E2435 114G4527	114G4627	SC15G	G	BG4/5	1	254	1,1
MBP	114E2442 114E2567 114E4023	-	114G5728	114E2357 114E2418 114G5528	-	SC18G	G	BG4/5	1	254	1,1
MBP	114E2459 114E2551	-	114G5730	114E2419 114G5530	-	SC21G	G	BG4/5	1	254	1,1
MBP	114E2540	-	114E2529 114H6745	-	-	SC15DL	DL	BG6	1	300	2,4
MBP	-	-	114E2586	-	-	SC15MLX	ML	BG6	1	300	2,4
MBP	-	-	114E2587	-	-	SC18MLX	ML	BG7	1	300	2,4
MBP	-	-	114G6380 114G6780	-	-	SC12/12G	G	BG6	1	300	2,4
MBP	-	-	114H7347 114H7747	-	-	SC10/10DL	DL	BG7	1	300	2,4
MBP	-	-	114H7348 114H7748	-	-	SC12/12DL	DL	BG7	1	300	2,4
MBP	-	-	114G7381 114G7781	-	-	SC15/15G	G	BG7	1	300	2,4
MBP	-	-	114H7349 114H7749	-	-	SC15/15DL	DL	BG7	1	300	2,4
MBP	114E2128	-	114G7382 114G7782	-	-	SC18/18G	G	BG7	1	300	2,4
MBP	114E2149	-	114G7383 114G7783	-	-	SC21/21G	G	BG7	1	300	2,4
LBP/MBP	-	-	-	114F1504	-	TL5CN	CN	BG1	1	170	-
LBP/MBP	-	-	-	114F1508	-	TL4CN	CN	BG1	1	170	-
LBP/MBP	-	-	-	114F2505	-	NL7CN	CN	BG2	1	200	-
LBP/MBP	-	-	-	114F3500	-	SC10CN	CN	BG3	1	230	-
LBP/MBP	-	-	-	114F3509	-	NL9CN	CN	BG2	1	200	-
LBP/MBP	-	-	-	114F4501	-	SC12CN	CN	BG4/5	1	254	-
LBP/MBP	-	-	-	114F4502	-	SC15CN	CN	BG4/5	1	254	-
LBP/MBP	-	-	-	114F4503	-	SC18CN	CN	BG4/5	1	254	-

A petición, cable de alimentación añadido a modelos no incluidos en el catálogo

### UL - Datos técnicos

Aplicación	Versión				Compresor	Refrigerante	Condensador	Ventilador		Volumen del recipiente (l)
	T0	T1	T2	N0				Cantidad	Diámetro (mm)	
LBP			114G2573		NL11F	F	BG2	1	200	0,8
LBP	114E2403				SC10CLX	CL	BG3	1	230	1,2
LBP	114H4515		114E4018		SC12CL	CL	BG4/5	1	254	1,1
LBP				114H5953	SC18CLX	CL	BG4/5	1	254	1,1
LBP			114E2495		SC15CLX	CL	BG4/5	1	254	1,1
LBP			114E4024		SC15CLX	CL	BG4/5	1	254	1,1
LBP				114F5062	SC12/12CL	CL	BG4/5	1	254	1,1
LBP	114F0207 114F0208				DLE4.8CN	CN	BG2	1	200	0,8
MBP	114G1900	114G1660		114G1760 114G1940	TL4G	G	BG1	1	170	0,8
MBP			114E4020		FF8.5GX	G	BG3	1	230	1,2
MBP			114E4021	114G3768	FF10GX	G	BG3	1	230	1,2
MBP	114E2397		114E4022	114G3942	SC12G	G	BG3	1	230	1,2
MBP			114E4002		SC15G	G	BG4/5	1	254	1,1
MBP				114G5946	SC18GH	G	BG4/5	1	254	1,1

## Instruktioner

### Bilaga – A, Tekniska data

#### Etikettinformation

<b>Optyma™</b> by Danfoss      EAN No : <b>Serial No 29XXXXXXX</b>			
Refrigerant: (1) Rxxxx (2)		<b>114X1219</b> <b>Model: XXXXXXXX</b>	
Max. Working Pressure HP (1) xx  According with EN 378 and temperature 46°C		Comp: xxx- xxxV xxHz Fan: xxx- xxxV xxHz- xxHz Refr. Charge < 150g	
		If imported from UK - Danfoss Ltd., 22 Wycombe End, HP9 1NB, GB Імпортер: ТОВ з іі "Данфосс ТОВ" 04080, Київ 80, п/с 168, Україна	

- A:** Artikelnummer för det luftkylda aggregatet  
**B:** Tillverkningsserienummer  
**C:** Köldmedium  
**D:** Modellbeteckning  
**E:** Strömförsörjning för kompressor och fläktmotor

### Benämning – Katalog

**OP - LCQN 048 MT A00 E**

OP = Optyma

1 2 3 4 5 6 7 8

1	<b>Tillämpning:</b> <b>M</b> = Medelhögt mottryck ; <b>L</b> = Lågt mottryck
2	<b>Kompressorplattform:</b> <b>C:</b> Luftkylt aggregat med enkel fläkt
3	<b>Köldmedium:</b> <b>G:</b> R134a, R513A; H: R404A/R507; <b>Q:</b> R452A, R404A/R507; <b>N:</b> R290
4	<b>Kondensorns utformning:</b> <b>C:</b> Kondensor med flänsar och rör, omgivningstemperatur på upp till 43 °C
5	<b>Kompressorförskjutning:</b> Exempel 048 = 48 cm <sup>3</sup>
6	<b>Plattform för kolvkompressor:</b> FR = FR, NF = NF, SC = SC, GS = GS, NX = NX, NB = NBC, NS = NS, NU = NUY, NP = NPT, MP = MPT, MY = MLY, MX = MX, TL = TL, NL = NL
7	<b>Version:</b> A00, A01, A04, A09, A10, A11. Se tabellen Funktionsöversikt för funktioner inom varje version.
8	<b>Spänningskod:</b> G: Kompressor 230 V/1P/50 Hz, fläkt 230 V/1P/50 Hz E: Kompressor 400 V/3P/50 Hz, fläkt 230V/1P/50 Hz

	Mindre kommersiell			Mindre kommersiell R290		
	A00	A01	A04	A09	A10	A11
Omgivningstemperatur	Upp till 43 °C			Upp till 43 °C		
Hermetisk kolvkompressor	MPT, MLY, NL, SC, GS, FR, TL, NF			NUY, NBC, NPT, NS, NX		
Enhetsbas	Skenor eller basplatta					
Typ av kondensor	Med flänsar och rör (målad)					
Fläkt	AC/EC	AC/EC	AC/EC	EC	EC	EC
Fäste och rör för pressostatmontering	-	ja	ja	ja	-	-
Dubbel pressostat – KP 17 WB	-	-	ja	-	-	-
Schraderventil	-	-	-	ja	ja	ja
Kopplat elskåp	ja	ja	ja	ja	ja	ja
Mini HP/LP-pressostat	-	-	-	-	ja	-
Strömkabel	-	-	ja	-	ja	-
Köldmediebehållare	-	ja	ja	-	Kombinerad torkare + behållare	-

## Instruktioner

### Beteckning – ej katalog

#### SC 18 G X T2

T T T T T  
1 2 3 4 5

1	<b>Kompressorplattform:</b> <b>PL, TL, NL, FR, SC, GS</b>
2	<b>Kompressorförskjutning:</b> Exempel 048 = 48 cm <sup>3</sup>
3	<b>Tillämpning och köldmedium:</b> <b>CM</b> = LBP; R22 <b>CL</b> = LBP; R404A/R507 <b>CN</b> = LBP/MBP; R290 <b>CP</b> = LBP; R404A/R507, R452A <b>DM</b> = HBP; R22 <b>DL</b> = HBP; R404A/R507 <b>F</b> = LBP/(MBP); R134a <b>FT</b> = LBP tropisk; R134a <b>G</b> = LBP/MBP/HBP; R134a & R513A <b>GH</b> = Värmepump, optimerad; R134a <b>MF</b> = MBP; R134a <b>ML</b> = MBP; R404A/507
4	<b>Startegenskaper:</b> <b>X</b> = HST <b>K</b> = LST
5	<b>Version:</b> N0 – för kapillärrör – utan avstängningsventiler, utan behållare N1 – för kapillärrör – med 1 x avstängningsventil, utan behållare N2 – för kapillärrör – med 2 x avstängningsventiler, utan behållare T0 – för expansionsventil – med behållare utan 2 x avstängningsventiler T1 – för expansionsventil – med behållare med 1 x avstängningsventil T2 – för expansionsventil – med behållare med 2 x avstängningsventiler

	Mindre kommersiell					
	N0	N1	N2	T0	T1	T2
Omgivningstemperatur	Upp till 43 °C					
Hermetisk kolvkompressor	NL, SC, GS, FR, TL, NF, DL					
Enhetsbas	Skenor eller basplatta					
Typ av kondensor	Med flänsar och rör (målad)					
Schraderventil	-	-	-	ja	ja	ja
Kopplat elskåp	ja	ja	ja	ja	ja	ja
Serviceventil	-	ja*	ja	-	ja*	ja
Köldmediebehållare	-	-	-	ja	ja	ja

\*) 1 x Serviceventil

## Instruktioner

### Katalogmodeller

#### Mindre kommersiella - tekniska data

Tillämpning	Version			Beskrivning	Kompressor	Elektrisk kod	Köldmedium	Kondensorspole		Fläkt		Behållarvolym (liter)	Sugledning	Vätskeledning
	A00	A01	A04					Beteckning	Intern volym (liter)	Antal	Blad (mm)			
LBP	114X1208	114X1209	114X1211	OP-LCHC004TL	TL4CL	G	H	BG2	0,25	1	200	0,8	1/4"	1/4"
LBP		114X1221		OP-LCQC004ML	MLY45Lab	G	Q	BG2	0,25	1	200	0,8	3/8"	1/4"
LBP	114X1216	114X1217	114X1219	OP-LCHC006FR	FR6CL	G	H	BG2	0,25	1	200	0,8	3/8"	1/4"
LBP		114X1337		OP-LCQC006ML	MLY60Lab	G	Q	BG3	0,31	1	230	1,1	3/8"	1/4"
LBP	114X1328	114X1329	114X1331	OP-LCHC007NL	NL7CLX	G	H	BG3	0,31	1	230	1,1	3/8"	1/4"
LBP	114X1324	114X1325	114X1327	OP-LCHC008FR	FR8, 5CL	G	H	BG3	0,31	1	230	1,1	3/8"	1/4"
LBP	114X1304	114X1301	114X1302	OP-LCHC008NL	NL8.4CLX	G	H	BG3	0,31	1	230	1,1	3/8"	1/4"
LBP		114X1341		OP-LCQC008ML	MLY80Lab	G	Q	BG3	0,31	1	230	1,1	3/8"	1/4"
LBP	114X1440	114X1441	114X1443	OP-LCHC012SC	SC12CL	G	H	BG4/5	0,4	1	254	1,1	3/8"	1/4"
LBP	114X1444			OP-LCHC012SC	SC12CLX.2	G	H	BG4/5	0,4	1	254	1,1	3/8"	1/4"
LBP		114X1449		OP-LCQC012ML	MLY12Lab	G	Q	BG4/5	0,4	1	254	1,1	3/8"	1/4"
LBP		114X1569		OP-LCQC012MP	MPT12LA	G	Q	BG4/5	0,4	1	254	1,1	3/8"	1/4"
LBP		114X1573		OP-LCQC014MP	MPT14LA	G	Q	BG4/5	0,4	1	254	1,1	1/2"	1/4"
LBP	114X1548	114X1549	114X1551	OP-LCHC015SC	SC15CLX	G	H	BG4/5	0,4	1	254	1,1	3/8"	1/4"
LBP	114X1556	114X1557	114X1559	OP-LCHC018SC	SC18CL	G	H	BG4/5	0,4	1	254	1,1	1/2"	1/4"
LBP	114X1600	114X1601	114X1602	OP-LCHC021SC	SC21CL	G	H	BG6	0,63	1	300	1,1	1/2"	1/4"
LBP		114X1673		OP-LCHC026GS	GS26CLX	G	H	BG6	0,63	1	300	2,4	1/2"	3/8"
LBP		114X1781	114X1783	OP-LCHC034GS	GS34CLX	G	H	BG7	0,84	1	300	2,4	1/2"	3/8"
MBP	114X0104	114X0105	114X0107	OP-MCGC003TL	TL3GX	G	G	BG1	0,13	1	172	0,8	1/4"	1/4"
MBP	114X0108	114X0109	114X0111	OP-MCGC004TL	TL4GX	G	G	BG1	0,13	1	172	0,8	1/4"	1/4"
MBP	114X0301	114X0302	114X0303	OP-MCHC004TL	TL4DL	G	H	BG3	0,31	1	230	1,1	3/8"	1/4"
MBP	114X0112	114X0113	114X0115	OP-MCGC005TL	TL5GX	G	G	BG1	0,13	1	172	0,8	1/4"	1/4"
MBP	114X0200	114X0201	114X0203	OP-MCGC006FR	FR6GX	G	G	BG2	0,25	1	200	0,8	3/8"	1/4"
MBP	114X2316	114X2317	114X2319	OP-MCHC006FR	FR6DLX	G	H	BG3	0,31	1	230	1,1	3/8"	1/4"
MBP	114X0228			OP-MCGC006NL	NL6.1MF	G	G	BG2	0,25	1	200	0,8	3/8"	1/4"
MBP	114X0216	114X0217	114X0219	OP-MCGC007FR	FR7.5GX	G	G	BG2	0,25	1	200	0,8	3/8"	1/4"
MBP	114X0244			OP-MCGC007NL	NL7.3MF	G	G	BG2	0,25	1	200	0,8	3/8"	1/4"
MBP	114X2424	114X2425	114X2427	OP-MCHB007NF	NF7MLX	G	H	BG4/5	0,4	1	254	1,1	3/8"	1/4"
MBP	114X0224	114X0225	114X0227	OP-MCGC008FR	FR8,5GX	G	G	BG2	0,25	1	200	0,8	3/8"	1/4"
MBP	114X0204	114X0205		OP-MCGC008NL	NL8.4MF	G	G	BG2	0,25	1	200	0,8	3/8"	1/4"
MBP	114X0352			OP-MCGC008NL	NL8.4MF	G	G	BG3	0,31	1	230	-	3/8"	1/4"
MBP			114X0223	OP-MCGC010SC	SC10GX	G	G	BG2	0,25	1	200	0,8	3/8"	1/4"
MBP	114X0403	114X0404	114X0405	OP-MCHC010SC	SC10MLX	G	H	BG4/5	0,4	1	254	1,1	3/8"	1/4"
MBP	114X0336	114X0337	114X0339	OP-MCGC011FR	FR11GX	G	G	BG3	0,31	1	230	1,1	3/8"	1/4"
MBP	114X0340	114X0341	114X0343	OP-MCGC012SC	SC12GX	G	G	BG3	0,31	1	230	1,1	3/8"	1/4"
MBP	114X0406	114X0407	114X0408	OP-MCHC013SC	SC12MLX	G	H	BG4/5	0,4	1	254	1,1	3/8"	1/4"
MBP	114X0448	114X0449	114X0451	OP-MCGC015SC	SC15GX	G	G	BG4/5	0,4	1	254	1,1	3/8"	1/4"
MBP		114X2649	114X2651	OP-MCHC015SC	SC15MLX	G	H	BG6	1,1	1	300	1,1	1/2"	1/4"
MBP	114X0556	114X0557	114X0559	OP-MCGC018SC	SC18G	G	G	BG4/5	0,4	1	254	1,1	3/8"	1/4"
MBP		114X0702	114X0703	OP-MCHC018SC	SC18MLX	G	H	BG7	0,84	1	300	1,1	1/2"	1/4"
MBP	114X0568			OP-MCGC021SC	SC21MF	G	G	BG4/5	0,4	1	254	1,1	3/8"	1/4"
MBP	114X0564	114X0565	114X0567	OP-MCGC021SC	SC21GX	G	G	BG4/5	0,4	1	254	1,1	3/8"	1/4"
MBP		114X2765	114X2767	OP-MCHC021GS	GS21MLX	G	H	BG7	0,84	1	300	1,6	5/8"	3/8"
MBP		114X0773		OP-MCGC026GS	GS26MFX	G	G	BG7	0,84	1	300	2,4	3/8"	1/4"
MBP		114X0781		OP-MCGC034GS	GS34MFX	G	G	BG7	0,84	1	300	2,4	1/2"	3/8"



## Instruktioner

### R290 – tekniska data

Tillämpning	Version			Beskrivning	Kompressor	Elektrisk kod	Köldmedium	Kondenserspole		Fläkt		Behållarvolym (liter)	Sugledning (mm)	Vätskeledning (mm)
	A09	A10	A11					Beteckning	Intern volym (liter)	Antal	Blad (mm)			
LBP	114F0202	114F0203	114F0201	OP-LCNC004NU	NUY45LAb	G	N	BG2	0,25	1	200	0,114	6	6
LBP	114F0205	114F0206	114F0204	OP-LCNC006NU	NUT60CAe	G	N	BG2	0,25	1	200	0,114	6	6
LBP	114F0308	114F0309	114F0307	OP-LCNC008NU	NUY80LAb	G	N	BG3	0,31	1	230	0,114	6	6
LBP	114F0411	114F0412	114F0410	OP-LCNC011NY	NPY12LAb	G	N	BG4/5	0,4	1	254	0,165	8	6
LBP	114F0414	114F0415	114F0413	OP-LCNC016NP	NPT16LA	G	N	BG4/5	0,4	1	254	0,165	8	6
LBP	114F0417	114F0418	114F0416	OP-LCNC023NX	NX23FBa	G	N	BG4/5	0,4	1	254	0,165	10	6
LBP	114F0620	114F0621	114F0619	OP-LCNC034NS	NS34FB	G	N	BG6	0,63	1	300	0,32	12	6
MBP	114F1202	114F1203	114F1201	OP-MCNC003NB	NBC30RA	G	N	BG2	0,25	1	200	0,114	6	6
MBP	114F1205	114F1206	114F1204	OP-MCNC004NU	NUY45RAb	G	N	BG2	0,25	1	200	0,114	6	6
MBP	114F1308	114F1309	114F1307	OP-MCNC006NU	NUY60RAb	G	N	BG3	0,31	1	230	0,114	6	6
MBP	114F1411	114F1412	114F1410	OP-MCNC008NU	NUY80RAb	G	N	BG4/5	0,4	1	254	0,165	6	6
MBP	114F1414	114F1415	114F1413	OP-MCNC009NU	NUY90RAb	G	N	BG4/5	0,4	1	254	0,165	6	6
MBP	114F1417	114F1418	114F1416	OP-MCNC011NY	NLY12RAb	G	N	BG4/5	0,4	1	254	0,165	8	6
MBP	114F1420	114F1421	114F1419	OP-MCNC014NP	NPT14RA	G	N	BG4/5	0,4	1	254	0,165	8	6
MBP	114F1623	114F1624	114F1622	OP-MCNC016NP	NPT16RA	G	N	BG6	0,63	1	300	0,32	8	6
MBP	114F1626	114F1627	114F1625	OP-MCNC018NX	NX18TBa	G	N	BG6	0,63	1	300	0,32	10	6
MBP	114F1629	114F1630	114F1628	OP-MCNC020NX	NX21TBa	G	N	BG6	0,63	1	300	0,32	10	6

### Ej katalog – tekniska data

Tillämpning	Version					Kompressor	Köldmedium	Kondensör	Fläkt		Behållarvolym (liter)
	T0	T1	T2	N0	N2				Antal	Diameter (mm)	
LBP	-	-	-	-	114G1600	TL3F	F	BG2	1	200	0,8
LBP	-	-	114E2471	114H1506	-	TL4CL	CL	BG1	1	170	0,8
LBP	-	-	-	114E2123 114E2227	114G1602	TL55F	F	BG1	1	170	0,8
LBP	-	-	114H2726	114E2454 114E2503	-	FR6CL	CL	BG2	1	200	0,8
LBP	-	-	-	114G1512	114G1612	NL9F	F	BG2	1	200	0,8
LBP	-	-	-	-	114G2613	NL11F	F	BG2	1	200	0,8
LBP	-	-	-	114E2603	-	NL8.4MF	MF	BG2	1	200	0,8
LBP	-	-	-	114E2577 114H3546	-	NL8.4CLX	CL	BG3	1	230	1,1
LBP	114E2593	114E2517	114H3728	-	-	FR8, 5CL	CL	BG3	1	230	1,1
LBP	-	114E2156	114H3730	114E2198 114E2452 114E2534	-	SC10CL	CL	BG3	1	230	1,1
LBP	-	-	-	-	114G1611	NL7F	F	BG4/5	1	254	1,1
LBP	-	-	114H4731	-	-	SC12CL	CL	BG4/5	1	254	1,1
LBP	114E2536	-	114H5732	-	114E2361	SC15CL	CL	BG4/5	1	254	1,1
LBP	114E4007	-	114H5733	114H5533 114E2172	-	SC18CL	CL	BG4/5	1	254	1,1
LBP	114E2353 114E2555 114E4003	-	-	-	-	SC21CL	CL	BG4/5	1	254	1,1
LBP	-	-	114H6735 114H6335	-	-	SC10/10CL	CL	BG6	1	300	2,4
LBP	-	-	114H7736 114H7336 114F5052	-	-	SC12/12CL	CP	BG7	1	300	2,4
LBP	-	-	114H7337 114F5053 114H7737	-	-	SC15/15CL	CL	BG7	1	300	2,4
LBP	114E2546	-	114H7338 114H7738	-	-	SC18/18CL	CP	BG7	1	300	2,4
LBP	-	-	114H7339 114H7739	-	-	SC21/21CL	CP	BG7	1	300	2,4
MBP	-	-	-	114G0503	-	PL35G	G	BG0	1	172	-
MBP	-	-	-	114E2203 114G0502	-	PL50F	F	BG0	1	172	-
MBP	114B0017	-	-	-	-	BD250GH	G	BG0.5	1	172	-
MBP	-	-	114G1706	114G1506	114G1606	TL4G	G	BG1	1	170	0,8
MBP	114E2548	-	114G1708	114E2492 114E2541	-	TL5G	G	BG1	1	170	0,8
MBP	-	-	-	114B0006 114G1901	-	TL4GH	G	BG1	1	170	0,8
MBP	-	-	-	114G2515	114G2615	FR6G	G	BG2	1	200	0,8
MBP	-	-	-	114G2518	-	FR7.5G	G	BG2	1	200	0,8
MBP	114E2346	-	114G2716	114E2201 114E2332 114G2516	114G2616	FR8.5G	G	BG2	1	200	0,8
MBP	114E2410 114E2519 114E2522	-	-	114E2362	-	FR8.5G	G	BG2	1	200	0,8

## Instruktioner

### Ej katalog – tekniska data (forts.)

Tillämpning	Version					Kompressor	Köldmedium	Kondensator	Fläkt		Behållarvolym (liter)
	T0	T1	T2	N0	N2				Antal	Diameter (mm)	
MBP		-	114G2719	-	-	FR10G	G	BG2	1	200	0,8
MBP	114E2347 114E2411 114E2520 114E2544	-	-	114E2333 114E2523	-	SC10G	G	BG2	1	200	0,8
MBP	-	-	114E2527 114H3727	-	-	FR6DL	DL	BG3	1	230	1,1
MBP	-	-	114G3717	114G3517	114G3617	FR11G	G	BG3	1	230	1,1
MBP	-	-	-	114G3536	-	NL10MF	MF	BG3	1	230	1,1
MBP	114E2351 114E2390 114E2549 114E2545 114E2457 114E2521	-	114G3726	114E2434 114G3526 114G9350 114G4565	114G3626	SC12G	G	BG3	1	230	1,1
MBP	-	-	114E2528 114H5743	-	-	SC10DL	DL	BG4/5	1	254	1,1
MBP	-	-	114H5744	-	-	SC12DL	DL	BG4/5	1	254	1,1
MBP	114E2352 114E2391 114E2550	-	114G4727	114E2435 114G4527	114G4627	SC15G	G	BG4/5	1	254	1,1
MBP	114E2442 114E2567 114E4023	-	114G5728	114E2357 114E2418 114G5528	-	SC18G	G	BG4/5	1	254	1,1
MBP	114E2459 114E2551	-	114G5730	114E2419 114G5530	-	SC21G	G	BG4/5	1	254	1,1
MBP	114E2540	-	114E2529 114H6745	-	-	SC15DL	DL	BG6	1	300	2,4
MBP	-	-	114E2586	-	-	SC15MLX	ML	BG6	1	300	2,4
MBP	-	-	114E2587	-	-	SC18MLX	ML	BG7	1	300	2,4
MBP	-	-	114G6380 114G6780	-	-	SC12/12G	G	BG6	1	300	2,4
MBP	-	-	114H7347 114H7747	-	-	SC10/10DL	DL	BG7	1	300	2,4
MBP	-	-	114H7348 114H7748	-	-	SC12/12DL	DL	BG7	1	300	2,4
MBP	-	-	114G7381 114G7781	-	-	SC15/15G	G	BG7	1	300	2,4
MBP	-	-	114H7349 114H7749	-	-	SC15/15DL	DL	BG7	1	300	2,4
MBP	114E2128	-	114G7382 114G7782	-	-	SC18/18G	G	BG7	1	300	2,4
MBP	114E2149	-	114G7383 114G7783	-	-	SC21/21G	G	BG7	1	300	2,4
LBP/MBP	-	-	-	114F1504	-	TL5CN	CN	BG1	1	170	-
LBP/MBP	-	-	-	114F1508	-	TL4CN	CN	BG1	1	170	-
LBP/MBP	-	-	-	114F2505	-	NL7CN	CN	BG2	1	200	-
LBP/MBP	-	-	-	114F3500	-	SC10CN	CN	BG3	1	230	-
LBP/MBP	-	-	-	114F3509	-	NL9CN	CN	BG2	1	200	-
LBP/MBP	-	-	-	114F4501	-	SC12CN	CN	BG4/5	1	254	-
LBP/MBP	-	-	-	114F4502	-	SC15CN	CN	BG4/5	1	254	-
LBP/MBP	-	-	-	114F4503	-	SC18CN	CN	BG4/5	1	254	-

Baserat på begäran har strömkabel lagts till på modeller som inte är katalogmodeller

### UL – tekniska data

Tillämpning	Version				Kompressor	Köldmedium	Kondensator	Fläkt		Behållarvolym (liter)
	T0	T1	T2	N0				Antal	Diameter (mm)	
LBP			114G2573		NL11F	F	BG2	1	200	0,8
LBP	114E2403				SC10CLX	CL	BG3	1	230	1,2
LBP	114H4515		114E4018		SC12CL	CL	BG4/5	1	254	1,1
LBP				114H5953	SC18CLX	CL	BG4/5	1	254	1,1
LBP			114E2495		SC15CLX	CL	BG4/5	1	254	1,1
LBP			114E4024		SC15CLX	CL	BG4/5	1	254	1,1
LBP				114F5062	SC12/12CL	CL	BG4/5	1	254	1,1
LBP	114F0207 114F0208				DLE4.8CN	CN	BG2	1	200	0,8
MBP	114G1900	114G1660		114G1760 114G1940	TL4G	G	BG1	1	170	0,8
MBP			114E4020		FF8.5GX	G	BG3	1	230	1,2
MBP			114E4021	114G3768	FF10GX	G	BG3	1	230	1,2
MBP	114E2397		114E4022	114G3942	SC12G	G	BG3	1	230	1,2
MBP			114E4002		SC15G	G	BG4/5	1	254	1,1
MBP				114G5946	SC18GH	G	BG4/5	1	254	1,1

## Instructies

### Bijlage – A, Technische gegevens

#### Labelinformatie

<b>Optyma™</b> by Danfoss					
<b>EAN No :</b>				<b>MADE IN ITALY</b>	
<b>Serial No 29XXXXXXX</b>					
<b>Refrigerant:</b> (1) Rxxxx (2)		<b>114X1219</b>		<b>A</b>	
		<b>Model: XXXXXXXX</b>		<b>D</b>	
<b>Max. Working Pressure</b> HP (1) xx		<b>Comp: xxx- xxxV xxHz</b>		<b>E</b>	
<b>According with EN 378 and temperature 46°C</b>		<b>Fan: xxx- xxxV xxHz- xxHz</b>			
		<b>Refr. Charge &lt; 150g</b>			
		<b>If imported from UK - Danfoss Ltd., 22 Wycombe End, HP9 1NB, GB</b>			
		<b>Імпортёр: ТОВ з іі "Данфосс ТОВ" 04080, Київ 80, п/с 168, Україна</b>			

**A:** Bestelnummer van de koelgroep

**B:** Serienummer

**C:** Koudemiddel

**D:** Modelaanduiding

**E:** Voeding voor compressor en ventilatormotor

### Aanduiding – Catalogus

#### OP – LCQN 048 MT A00 E

OP = Optyma

1 2 3 4 5 6 7 8

1	<b>Toepassing:</b> M = Middelhoge tegendruk; L = Lage tegendruk
2	<b>Compressorplatform:</b> C: Luchtgekoelde koelgroep met enkele ventilator
3	<b>Koudemiddel:</b> G: R134a, R513A; H: R404A/R507; Q: R452A, R404A/R507; N: R290
4	<b>Condensorontwerp:</b> C: Vin- en buiscondensor, omgevingstemperatuur tot 43 °C
5	<b>Slagvolume compressor:</b> Voorbeeld 048 = 48 cm <sup>3</sup>
6	<b>Platform zuigercompressor:</b> FR = FR, NF = NF, SC = SC, GS = GS, NX = NX, NB = NBC, NS = NS, NU = NUY, NP = NPT, MP = MPT, MY = MLY, MX = MX, TL = TL, NL = NL
7	<b>Versie:</b> A00, A01, A04, A09, A10, A11. Zie de tabel Overzicht van de kenmerken voor de kenmerken in elke versie.
8	<b>Elektrische code:</b> G: Compressor 230 V / 1 fase / 50 Hz, ventilator 230 V / 1 fase / 50 Hz E: Compressor 400 V / 3 fasen / 50 Hz, ventilator 230 V / 1 fase / 50 Hz

	Licht commercieel			Licht commercieel R290		
	A00	A01	A04	A09	A10	A11
Omgevingstemperatuur	Tot 43 °C			Tot 43 °C		
Platform hermetische zuigercompressor	MPT, MLY, NL, SC, GS, FR, TL, NF			NUY, NBC, NPT, NS, NX		
Basis van eenheid	Rails of grondplaat					
Condensortype	Vin & buis (geverfd)					
Ventilator	AC/EC	AC/EC	AC/EC	EC	EC	EC
Beugel & leiding voor montage pressostaat	-	Ja	Ja	Ja	-	-
Dubbele drukschakelaar – KP 17 WB	-	-	Ja	-	-	-
Schraderklep	-	-	-	Ja	Ja	Ja
Bedrade schakelkast	Ja	Ja	Ja	Ja	Ja	Ja
Mini HD/LD-pressostaat	-	-	-	-	Ja	-
Voedingskabel	-	-	Ja	-	Ja	-
Vloeistofvat	-	Ja	Ja	-	Combodroger + vloeistofvat	-

## Instructies

### Aanduiding – Niet-catalogus

#### SC 18 G X T2

T T T T T  
1 2 3 4 5

1	<b>Compressorplatform:</b> PL, TL, NL, FR, SC, GS
2	<b>Slagvolume compressor:</b> Voorbeeld 048 = 48 cm <sup>3</sup>
3	<b>Toepassing en koudemiddel:</b> <b>CM</b> = LBP; R22 <b>CL</b> = LBP; R404A/R507 <b>CN</b> = LBP/MBP; R290 <b>CP</b> = LBP; R404A/R507, R452A <b>DM</b> = HBP; R22 <b>DL</b> = HBP; R404A/R507 <b>F</b> = LBP/(MBP); R134a <b>FT</b> = LBP tropisch; R134a <b>G</b> = LBP/MBP/HBP; R134a & R513A <b>GH</b> = Warmtepomp geoptimaliseerd; R134a <b>MF</b> = MBP; R134a <b>ML</b> = MBP; R404A/507
4	<b>Startkenmerken:</b> <b>X</b> = HST <b>K</b> = LST
5	<b>Versie:</b> N0 – Voor capillair – zonder afsluitkleppen, zonder vloeistofvat N1 – Voor capillair – met 1x afsluitklep, zonder vloeistofvat N2 – Voor capillair – met 2x afsluitklep, zonder vloeistofvat T0 – Voor expansieventiel – met vloeistofvat zonder 2x afsluitklep T1 – Voor expansieventiel – met vloeistofvat met 1x afsluitklep T2 – Voor expansieventiel – met vloeistofvat met 2x afsluitklep

	Licht commercieel					
	N0	N1	N2	T0	T1	T2
Omgevingstemperatuur	Tot 43 °C					
Hermetische zuigercompressor	NL, SC, GS, FR, TL, NF, DL					
Basis van eenheid	Rails of grondplaat					
Condensortype	Vin & buis (geverfd)					
Schraderklep	-	-	-	Ja	Ja	Ja
Bedrade schakelkast	Ja	Ja	Ja	Ja	Ja	Ja
Serviceafsluiter	-	Ja*	Ja	-	Ja*	Ja
Vloeistofvat	-	-	-	Ja	Ja	Ja

\*) 1x Serviceafsluiter

## Instructies

### Catalogusmodellen

#### Light Commercial – Technische gegevens

Toepassing	Versie			Beschrijving	Compressor	Elektrische code	Koudemiddelen	Condensor		Ventilator		Volume vloeistofvat (l)	Zuigleiding	Vloeistofleiding
	A00	A01	A04					Aanduiding	Inwendig volume (l)	Aantal	Blad (mm)			
LBP	114X1208	114X1209	114X1211	OP-LCHC004TL	TL4CL	G	H	BG2	0,25	1	200	0,8	1/4"	1/4"
LBP		114X1221		OP-LCQC004ML	MLY45LAb	G	Q	BG2	0,25	1	200	0,8	3/8"	1/4"
LBP	114X1216	114X1217	114X1219	OP-LCHC006FR	FR6CL	G	H	BG2	0,25	1	200	0,8	3/8"	1/4"
LBP		114X1337		OP-LCQC006ML	MLY60LAb	G	Q	BG3	0,31	1	230	1,1	3/8"	1/4"
LBP	114X1328	114X1329	114X1331	OP-LCHC007NL	NL7CLX	G	H	BG3	0,31	1	230	1,1	3/8"	1/4"
LBP	114X1324	114X1325	114X1327	OP-LCHC008FR	FR8.5CL	G	H	BG3	0,31	1	230	1,1	3/8"	1/4"
LBP	114X1304	114X1301	114X1302	OP-LCHC008NL	NL8.4CLX	G	H	BG3	0,31	1	230	1,1	3/8"	1/4"
LBP		114X1341		OP-LCQC008ML	MLY80LAb	G	Q	BG3	0,31	1	230	1,1	3/8"	1/4"
LBP	114X1440	114X1441	114X1443	OP-LCHC012SC	SC12CL	G	H	BG4/5	0,4	1	254	1,1	3/8"	1/4"
LBP	114X1444			OP-LCHC012SC	SC12CLX.2	G	H	BG4/5	0,4	1	254	1,1	3/8"	1/4"
LBP		114X1449		OP-LCQC012ML	MLY12LAb	G	Q	BG4/5	0,4	1	254	1,1	3/8"	1/4"
LBP		114X1569		OP-LCQC012MP	MPT12LA	G	Q	BG4/5	0,4	1	254	1,1	3/8"	1/4"
LBP		114X1573		OP-LCQC014MP	MPT14LA	G	Q	BG4/5	0,4	1	254	1,1	1/2"	1/4"
LBP	114X1548	114X1549	114X1551	OP-LCHC015SC	SC15CLX	G	H	BG4/5	0,4	1	254	1,1	3/8"	1/4"
LBP	114X1556	114X1557	114X1559	OP-LCHC018SC	SC18CL	G	H	BG4/5	0,4	1	254	1,1	1/2"	1/4"
LBP	114X1600	114X1601	114X1602	OP-LCHC021SC	SC21CL	G	H	BG6	0,63	1	300	1,1	1/2"	1/4"
LBP		114X1673		OP-LCHC026GS	GS26CLX	G	H	BG6	0,63	1	300	2,4	1/2"	3/8"
LBP		114X1781	114X1783	OP-LCHC034GS	GS34CLX	G	H	BG7	0,84	1	300	2,4	1/2"	3/8"
MBP	114X0104	114X0105	114X0107	OP-MCGC003TL	TL3GX	G	G	BG1	0,13	1	172	0,8	1/4"	1/4"
MBP	114X0108	114X0109	114X0111	OP-MCGC004TL	TL4GX	G	G	BG1	0,13	1	172	0,8	1/4"	1/4"
MBP	114X0301	114X0302	114X0303	OP-MCHC004TL	TL4DL	G	H	BG3	0,31	1	230	1,1	3/8"	1/4"
MBP	114X0112	114X0113	114X0115	OP-MCGC005TL	TL5GX	G	G	BG1	0,13	1	172	0,8	1/4"	1/4"
MBP	114X0200	114X0201	114X0203	OP-MCGC006FR	FR6GX	G	G	BG2	0,25	1	200	0,8	3/8"	1/4"
MBP	114X2316	114X2317	114X2319	OP-MCHC006FR	FR6DLX	G	H	BG3	0,31	1	230	1,1	3/8"	1/4"
MBP	114X0228			OP-MCGC006NL	NL6.1MF	G	G	BG2	0,25	1	200	0,8	3/8"	1/4"
MBP	114X0216	114X0217	114X0219	OP-MCGC007FR	FR7.5GX	G	G	BG2	0,25	1	200	0,8	3/8"	1/4"
MBP	114X0244			OP-MCGC007NL	NL7.3MF	G	G	BG2	0,25	1	200	0,8	3/8"	1/4"
MBP	114X2424	114X2425	114X2427	OP-MCHB007NF	NF7MLX	G	H	BG4/5	0,4	1	254	1,1	3/8"	1/4"
MBP	114X0224	114X0225	114X0227	OP-MCGC008FR	FR8.5GX	G	G	BG2	0,25	1	200	0,8	3/8"	1/4"
MBP	114X0204	114X0205		OP-MCGC008NL	NL8.4MF	G	G	BG2	0,25	1	200	0,8	3/8"	1/4"
MBP	114X0352			OP-MCGC008NL	NL8.4MF	G	G	BG3	0,31	1	230	-	3/8"	1/4"
MBP			114X0223	OP-MCGC010SC	SC10GX	G	G	BG2	0,25	1	200	0,8	3/8"	1/4"
MBP	114X0403	114X0404	114X0405	OP-MCHC010SC	SC10MLX	G	H	BG4/5	0,4	1	254	1,1	3/8"	1/4"
MBP	114X0336	114X0337	114X0339	OP-MCGC011FR	FR11GX	G	G	BG3	0,31	1	230	1,1	3/8"	1/4"
MBP	114X0340	114X0341	114X0343	OP-MCGC012SC	SC12GX	G	G	BG3	0,31	1	230	1,1	3/8"	1/4"
MBP	114X0406	114X0407	114X0408	OP-MCHC013SC	SC12MLX	G	H	BG4/5	0,4	1	254	1,1	3/8"	1/4"
MBP	114X0448	114X0449	114X0451	OP-MCGC015SC	SC15GX	G	G	BG4/5	0,4	1	254	1,1	3/8"	1/4"
MBP		114X2649	114X2651	OP-MCHC015SC	SC15MLX	G	H	BG6	1,1	1	300	1,1	1/2"	1/4"
MBP	114X0556	114X0557	114X0559	OP-MCGC018SC	SC18G	G	G	BG4/5	0,4	1	254	1,1	3/8"	1/4"
MBP		114X0702	114X0703	OP-MCHC018SC	SC18MLX	G	H	BG7	0,84	1	300	1,1	1/2"	1/4"
MBP	114X0568			OP-MCGC021SC	SC21MF	G	G	BG4/5	0,4	1	254	1,1	3/8"	1/4"
MBP	114X0564	114X0565	114X0567	OP-MCGC021SC	SC21GX	G	G	BG4/5	0,4	1	254	1,1	3/8"	1/4"
MBP		114X2765	114X2767	OP-MCHC021GS	GS21MLX	G	H	BG7	0,84	1	300	1,6	5/8"	3/8"
MBP		114X0773		OP-MCGC026GS	GS26MFX	G	G	BG7	0,84	1	300	2,4	3/8"	1/4"
MBP		114X0781		OP-MCGC034GS	GS34MFX	G	G	BG7	0,84	1	300	2,4	1/2"	3/8"

## Instructies

### R290 – Technische gegevens

Toepassing	Versie			Beschrijving	Compressor	Elektrische code	Koudemiddelen	Condensator		Ventilator		Volume vloeistofvat (l)	Zuigleiding (mm)	Vloeistofleiding (mm)
	A09	A10	A11					Aanduiding	Inwendig volume (l)	Aantal	Blad (mm)			
LBP	114F0202	114F0203	114F0201	OP-LCNC004NU	NUY45Lab	G	N	BG2	0,25	1	200	0,114	6	6
LBP	114F0205	114F0206	114F0204	OP-LCNC006NU	NUT60CAe	G	N	BG2	0,25	1	200	0,114	6	6
LBP	114F0308	114F0309	114F0307	OP-LCNC008NU	NUY80Lab	G	N	BG3	0,31	1	230	0,114	6	6
LBP	114F0411	114F0412	114F0410	OP-LCNC011NY	NPY12Lab	G	N	BG4/5	0,4	1	254	0,165	8	6
LBP	114F0414	114F0415	114F0413	OP-LCNC016NP	NPT16LA	G	N	BG4/5	0,4	1	254	0,165	8	6
LBP	114F0417	114F0418	114F0416	OP-LCNC023NX	NX23FBa	G	N	BG4/5	0,4	1	254	0,165	10	6
LBP	114F0620	114F0621	114F0619	OP-LCNC034NS	NS34FB	G	N	BG6	0,63	1	300	0,32	12	6
MBP	114F1202	114F1203	114F1201	OP-MCNC003NB	NBC30RA	G	N	BG2	0,25	1	200	0,114	6	6
MBP	114F1205	114F1206	114F1204	OP-MCNC004NU	NUY45RAB	G	N	BG2	0,25	1	200	0,114	6	6
MBP	114F1308	114F1309	114F1307	OP-MCNC006NU	NUY60RAB	G	N	BG3	0,31	1	230	0,114	6	6
MBP	114F1411	114F1412	114F1410	OP-MCNC008NU	NUY80RAB	G	N	BG4/5	0,4	1	254	0,165	6	6
MBP	114F1414	114F1415	114F1413	OP-MCNC009NU	NUY90RAB	G	N	BG4/5	0,4	1	254	0,165	6	6
MBP	114F1417	114F1418	114F1416	OP-MCNC011NY	NLY12RAB	G	N	BG4/5	0,4	1	254	0,165	8	6
MBP	114F1420	114F1421	114F1419	OP-MCNC014NP	NPT14RA	G	N	BG4/5	0,4	1	254	0,165	8	6
MBP	114F1623	114F1624	114F1622	OP-MCNC016NP	NPT16RA	G	N	BG6	0,63	1	300	0,32	8	6
MBP	114F1626	114F1627	114F1625	OP-MCNC018NX	NX18TBa	G	N	BG6	0,63	1	300	0,32	10	6
MBP	114F1629	114F1630	114F1628	OP-MCNC020NX	NX21TBa	G	N	BG6	0,63	1	300	0,32	10	6

### Niet-catalogus – Technische gegevens

Toepassing	Versie					Compressor	Koudemiddelen	Condensator	Ventilator		Volume vloeistofvat (l)
	T0	T1	T2	N0	N2				Aantal	Diameter (mm)	
LBP	-	-	-	-	114G1600	TL3F	F	BG2	1	200	0,8
LBP	-	-	114E2471	114H1506	-	TL4CL	CL	BG1	1	170	0,8
LBP	-	-	-	114E2123 114E2227	114G1602	TL55F	F	BG1	1	170	0,8
LBP	-	-	114H2726	114E2454 114E2503	-	FR6CL	CL	BG2	1	200	0,8
LBP	-	-	-	114G1512	114G1612	NL9F	F	BG2	1	200	0,8
LBP	-	-	-	-	114G2613	NL11F	F	BG2	1	200	0,8
LBP	-	-	-	114E2603	-	NL8.4MF	MF	BG2	1	200	0,8
LBP	-	-	-	114E2577 114H3546	-	NL8.4CLX	CL	BG3	1	230	1,1
LBP	114E2593	114E2517	114H3728	-	-	FR8.5CL	CL	BG3	1	230	1,1
LBP	-	114E2156	114H3730	114E2198 114E2452 114E2534	-	SC10CL	CL	BG3	1	230	1,1
LBP	-	-	-	-	114G1611	NL7F	F	BG4/5	1	254	1,1
LBP	-	-	114H4731	-	-	SC12CL	CL	BG4/5	1	254	1,1
LBP	114E2536	-	114H5732	-	114E2361	SC15CL	CL	BG4/5	1	254	1,1
LBP	114E4007	-	114H5733	114H5533 114E2172	-	SC18CL	CL	BG4/5	1	254	1,1
LBP	114E2353 114E2555 114E4003	-	-	-	-	SC21CL	CL	BG4/5	1	254	1,1
LBP	-	-	114H6735 114H6335	-	-	SC10/10CL	CL	BG6	1	300	2,4
LBP	-	-	114H7736 114H7336 114F5052	-	-	SC12/12CL	CP	BG7	1	300	2,4
LBP	-	-	114H7337 114F5053 114H7737	-	-	SC15/15CL	CL	BG7	1	300	2,4
LBP	114E2546	-	114H7338 114H7738	-	-	SC18/18CL	CP	BG7	1	300	2,4
LBP	-	-	114H7339 114H7739	-	-	SC21/21CL	CP	BG7	1	300	2,4
MBP	-	-	-	114G0503	-	PL35G	G	BG0	1	172	-
MBP	-	-	-	114E2203 114G0502	-	PL50F	F	BG0	1	172	-
MBP	114B0017	-	-	-	-	BD250GH	G	BG0.5	1	172	-
MBP	-	-	114G1706	114G1506	114G1606	TL4G	G	BG1	1	170	0,8
MBP	114E2548	-	114G1708	114E2492 114E2541	-	TL5G	G	BG1	1	170	0,8
MBP	-	-	-	114B0006 114G1901	-	TL4GH	G	BG1	1	170	0,8
MBP	-	-	-	114G2515	114G2615	FR6G	G	BG2	1	200	0,8
MBP	-	-	-	114G2518	-	FR7.5G	G	BG2	1	200	0,8
MBP	114E2346	-	114G2716	114E2201 114E2332 114G2516	114G2616	FR8.5G	G	BG2	1	200	0,8
MBP	114E2410 114E2519 114E2522	-	-	114E2362	-	FR8.5G	G	BG2	1	200	0,8

## Instructies

### Niet-catalogus – Technische gegevens (vervolg)

Toepassing	Versie					Compressor	Koudemiddelen	Condensator	Ventilator		Volume vloeistofvat (l)
	T0	T1	T2	N0	N2				Aantal	Diameter (mm)	
MBP		-	114G2719	-	-	FR10G	G	BG2	1	200	0,8
MBP	114E2347 114E2411 114E2520 114E2544	-	-	114E2333 114E2523	-	SC10G	G	BG2	1	200	0,8
MBP	-	-	114E2527 114H3727	-	-	FR6DL	DL	BG3	1	230	1,1
MBP	-	-	114G3717	114G3517	114G3617	FR11G	G	BG3	1	230	1,1
MBP	-	-	-	114G3536	-	NL10MF	MF	BG3	1	230	1,1
MBP	114E2351 114E2390 114E2549 114E2545 114E2457 114E2521	-	114G3726	114E2434 114G3526 114G9350 114G4565	114G3626	SC12G	G	BG3	1	230	1,1
MBP	-	-	114E2528 114H5743	-	-	SC10DL	DL	BG4/5	1	254	1,1
MBP	-	-	114H5744	-	-	SC12DL	DL	BG4/5	1	254	1,1
MBP	114E2352 114E2391 114E2550	-	114G4727	114E2435 114G4527	114G4627	SC15G	G	BG4/5	1	254	1,1
MBP	114E2442 114E2567 114E4023	-	114G5728	114E2357 114E2418 114G5528	-	SC18G	G	BG4/5	1	254	1,1
MBP	114E2459 114E2551	-	114G5730	114E2419 114G5530	-	SC21G	G	BG4/5	1	254	1,1
MBP	114E2540	-	114E2529 114H6745	-	-	SC15DL	DL	BG6	1	300	2,4
MBP	-	-	114E2586	-	-	SC15MLX	ML	BG6	1	300	2,4
MBP	-	-	114E2587	-	-	SC18MLX	ML	BG7	1	300	2,4
MBP	-	-	114G6380 114G6780	-	-	SC12/12G	G	BG6	1	300	2,4
MBP	-	-	114H7347 114H7747	-	-	SC10/10DL	DL	BG7	1	300	2,4
MBP	-	-	114H7348 114H7748	-	-	SC12/12DL	DL	BG7	1	300	2,4
MBP	-	-	114G7381 114G7781	-	-	SC15/15G	G	BG7	1	300	2,4
MBP	-	-	114H7349 114H7749	-	-	SC15/15DL	DL	BG7	1	300	2,4
MBP	114E2128	-	114G7382 114G7782	-	-	SC18/18G	G	BG7	1	300	2,4
MBP	114E2149	-	114G7383 114G7783	-	-	SC21/21G	G	BG7	1	300	2,4
LBP/MBP	-	-	-	114F1504	-	TL5CN	CN	BG1	1	170	-
LBP/MBP	-	-	-	114F1508	-	TL4CN	CN	BG1	1	170	-
LBP/MBP	-	-	-	114F2505	-	NL7CN	CN	BG2	1	200	-
LBP/MBP	-	-	-	114F3500	-	SC10CN	CN	BG3	1	230	-
LBP/MBP	-	-	-	114F3509	-	NL9CN	CN	BG2	1	200	-
LBP/MBP	-	-	-	114F4501	-	SC12CN	CN	BG4/5	1	254	-
LBP/MBP	-	-	-	114F4502	-	SC15CN	CN	BG4/5	1	254	-
LBP/MBP	-	-	-	114F4503	-	SC18CN	CN	BG4/5	1	254	-

Op basis van aanvraag: voedingskabel toegevoegd aan niet-catalogusmodellen

### UL – Technische gegevens

Toepassing	Versie				Compressor	Koudemiddelen	Condensator	Ventilator		Volume vloeistofvat (l)
	T0	T1	T2	N0				Aantal	Diameter (mm)	
LBP			114G2573		NL11F	F	BG2	1	200	0,8
LBP	114E2403				SC10CLX	CL	BG3	1	230	1,2
LBP	114H4515		114E4018		SC12CL	CL	BG4/5	1	254	1,1
LBP				114H5953	SC18CLX	CL	BG4/5	1	254	1,1
LBP			114E2495		SC15CLX	CL	BG4/5	1	254	1,1
LBP			114E4024		SC15CLX	CL	BG4/5	1	254	1,1
LBP				114F5062	SC12/12CL	CL	BG4/5	1	254	1,1
LBP	114F0207 114F0208				DLE4.8CN	CN	BG2	1	200	0,8
MBP	114G1900	114G1660		114G1760 114G1940	TL4G	G	BG1	1	170	0,8
MBP			114E4020		FF8.5GX	G	BG3	1	230	1,2
MBP			114E4021	114G3768	FF10GX	G	BG3	1	230	1,2
MBP	114E2397		114E4022	114G3942	SC12G	G	BG3	1	230	1,2
MBP			114E4002		SC15G	G	BG4/5	1	254	1,1
MBP				114G5946	SC18GH	G	BG4/5	1	254	1,1

## Ohjeet

### Liite - A, Tekniset tiedot

#### Etiketin tiedot

<b>Optyma™</b> by Danfoss			
<b>EAN No :</b>			<b>MADE IN ITALY</b>
<b>Serial No 29XXXXXXX</b>			
<b>Refrigerant:</b> (1) Rxxxx (2)	<b>114X1219</b>		<b>A</b>
<b>Max. Working Pressure</b> HP (1) xx	<b>Model: XXXXXXXX</b>		<b>D</b>
According with EN 378 and temperature 46°C	Comp: xxx-xxxV xxHz Fan: xxx-xxxV xxHz-xxHz Refr. Charge < 150g		<b>E</b>
If imported from UK - Danfoss Ltd., 22 Wycombe End, HP9 1NB, GB Імпорт: ТОВ з іі "Данфосс ТОВ" 04080, Київ 80, п/с 168, Україна			

**A:** Koneikon koodinumero

**B:** Tuotannon sarjanumero

**C:** Kylmäaine

**D:** Mallimerkintä

**E:** Virransyöttö kompressorin ja puhaltimen moottoriin

### Nimike - kuvasto

#### OP - LCQN 048 MT A00 E

OP = Optyma

1 2 3 4 5 6 7 8

1	<b>Sovellus:</b> <b>M</b> = keskisuuri vastapaine ; <b>L</b> = pieni vastapaine
2	<b>Kompressorialusta:</b> <b>C:</b> Ilmajäähdytteinen koneikko yhdellä puhaltimella
3	<b>Kylmäaine</b> <b>G:</b> R134a, R513A; H: R404A/R507; <b>Q:</b> R452A, R404A/R507; <b>N:</b> R290
4	<b>Lauhduttimen rakenne:</b> <b>C:</b> Lamellilauhdutin, ympäristön lämpötila enintään 43 °C
5	<b>Kompressorin iskutilavuus:</b> Esimerkki 048 = 48 cm <sup>3</sup>
6	<b>Mäntäkompressorin alusta:</b> FR = FR, NF = NF, SC = SC, GS = GS, NX = NX, NB = NBC, NS = NS, NU = NU, NP = NPT, MP = MPT, MY = MLY, MX = MX, TL = TL, NL = NL
7	<b>Versio:</b> A00, A01, A04, A09, A10, A11. Katso kunkin version ominaisuudet taulukosta Ominaisuuksien yleiskatsaus.
8	<b>Jännitekoodi:</b> G: Kompressorin 230 V / 1 vaihe / 50 Hz, puhalli n 230 V / 1 vaihe / 50 Hz E: Kompressorin 400 V / 3 vaihe / 50 Hz, puhallin 230 V / 1 vaihe / 50 Hz

	Light Commercial			Light Commercial R290		
	A00	A01	A04	A09	A10	A11
Ympäristön lämpötila	Enintään 43 °C			Enintään 43 °C		
Hermeettisen mäntäkompressorin alusta	MPT, MLY, NL, SC, GS, FR, TL, NF			NUY, NBC, NPT, NS, NX		
Koneikon jalusta	Kiskot tai pohjalevy					
Lauhduttimen tyyppi	Lamellipatteri (maalattu)					
Puhallin	AC/EC	AC/EC	AC/EC	EC	EC	EC
Kiinnike ja putki painekeytkimen asennukseen	-	kyllä	kyllä	kyllä	-	-
Kaksoispainekeytkin - KP 17 WB	-	-	kyllä	-	-	-
Schrader-venttiili	-	-	-	kyllä	kyllä	kyllä
Johdotettu sähkörasia	kyllä	kyllä	kyllä	kyllä	kyllä	kyllä
Mini-HP/LP-painekeytkin	-	-	-	-	kyllä	-
Virtajohto	-	-	kyllä	-	kyllä	-
Varaaja	-	kyllä	kyllä	-	Yhdistelmäkuivain + varaaja	-



## Ohjeet

### Nimike - ei kuvasto

#### SC 18 G X T2

T T T T T  
1 2 3 4 5

1	<b>Kompressorialusta:</b> <b>PL, TL, NL, FR, SC, GS</b>
2	<b>Kompressorin iskutilavuus:</b> Esimerkki 048 = 48 cm <sup>3</sup>
3	<b>Sovellus ja kylmäaine:</b> <b>CM</b> = LBP; R22 <b>CL</b> = LBP; R404A/R507 <b>CN</b> = LBP/MBP; R290 <b>CP</b> = LBP; R404A/R507, R452A <b>DM</b> = HBP; R22 <b>DL</b> = HBP; R404A/R507 <b>F</b> = LBP/(MBP); R134a <b>FT</b> = LBP trooppinen; R134a <b>G</b> = LBP/MBP/HBP; R134a & R513A <b>GH</b> = Lämpöpumppuoptimoitu; R134a <b>MF</b> = MBP; R134a <b>ML</b> = MBP; R404A/507
4	<b>Käynnistysominaisuudet:</b> <b>X</b> = HST <b>K</b> = LST
5	<b>Versio:</b> N0 - Kapillaariputkelle - ilman sulkuventtiiliä, ilman varaajaa N1 - Kapillaariputkelle - 1x sulkuventtiili, ilman varaajaa N2 - Kapillaariputkelle - 2x sulkuventtiili, ilman varaajaa T0 - Paisuntaventtiilille - varaajalla, ilman 2 x sulkuventtiiliä T1 - Paisuntaventtiilille - varaajalla ja 1x sulkuventtiili T2 - Paisuntaventtiilille - varaajalla ja 2 x sulkuventtiili

	Light Commercial					
	N0	N1	N2	T0	T1	T2
Ympäristön lämpötila	Enintään 43 °C					
Hermeettinen mäntäkompressor	MPT, MLY, NL, SC, GS, FR, TL, NF					
Koneikon jalusta	Kiskot tai pohjalevy					
Lauhduttimen tyyppi	Lamellipatteri (maalattu)					
Schrader-venttiili	-	-	-	kyllä	kyllä	kyllä
Johdotettu sähkörasia	kyllä	kyllä	kyllä	kyllä	kyllä	kyllä
Huoltoventtiili	-	kyllä*	kyllä	-	kyllä*	kyllä
Varaaja	-	-	-	kyllä	kyllä	kyllä

\*) 1 x huoltoventtiili

## Ohjeet

### Kuvastomallit

#### Light Commercial - Tekniset tiedot

Käyttökohde	Versio			Kuvaus	Kompressorit	Sähkökoodi	Kylmäaine	Lauhdutinkkenno		Puhallin		Varaajan tilavuus (L)	Imuputki	Nesteputki
	A00	A01	A04					Tyypimerkintä	Sisäinen tilavuus (L)	Numero	Siipi (mm)			
LBP	114X1208	114X1209	114X1211	OP-LCHC004TL	TL4CL	G	H	BG2	0,25	1	200	0,8	1/4"	1/4"
LBP		114X1221		OP-LCQC004ML	MLY45LAB	G	Q	BG2	0,25	1	200	0,8	3/8"	1/4"
LBP	114X1216	114X1217	114X1219	OP-LCHC006FR	FR6CL	G	H	BG2	0,25	1	200	0,8	3/8"	1/4"
LBP		114X1337		OP-LCQC006ML	MLY60LAB	G	Q	BG3	0,31	1	230	1,1	3/8"	1/4"
LBP	114X1328	114X1329	114X1331	OP-LCHC007NL	NL7CLX	G	H	BG3	0,31	1	230	1,1	3/8"	1/4"
LBP	114X1324	114X1325	114X1327	OP-LCHC008FR	FR8.5CL	G	H	BG3	0,31	1	230	1,1	3/8"	1/4"
LBP	114X1304	114X1301	114X1302	OP-LCHC008NL	NL8.4CLX	G	H	BG3	0,31	1	230	1,1	3/8"	1/4"
LBP		114X1341		OP-LCQC008ML	MLY80LAB	G	Q	BG3	0,31	1	230	1,1	3/8"	1/4"
LBP	114X1440	114X1441	114X1443	OP-LCHC012SC	SC12CL	G	H	BG4/5	0,4	1	254	1,1	3/8"	1/4"
LBP	114X1444			OP-LCHC012SC	SC12CLX.2	G	H	BG4/5	0,4	1	254	1,1	3/8"	1/4"
LBP		114X1449		OP-LCQC012ML	MLY12LAB	G	Q	BG4/5	0,4	1	254	1,1	3/8"	1/4"
LBP		114X1569		OP-LCQC012MP	MPT12LA	G	Q	BG4/5	0,4	1	254	1,1	3/8"	1/4"
LBP		114X1573		OP-LCQC014MP	MPT14LA	G	Q	BG4/5	0,4	1	254	1,1	1/2	1/4"
LBP	114X1548	114X1549	114X1551	OP-LCHC015SC	SC15CLX	G	H	BG4/5	0,4	1	254	1,1	3/8"	1/4"
LBP	114X1556	114X1557	114X1559	OP-LCHC018SC	SC18CL	G	H	BG4/5	0,4	1	254	1,1	1/2	1/4"
LBP	114X1600	114X1601	114X1602	OP-LCHC021SC	SC21CL	G	H	BG6	0,63	1	300	1,1	1/2	1/4"
LBP		114X1673		OP-LCHC026GS	GS26CLX	G	H	BG6	0,63	1	300	2,4	1/2	3/8"
LBP		114X1781	114X1783	OP-LCHC034GS	GS34CLX	G	H	BG7	0,84	1	300	2,4	1/2	3/8"
MBP	114X0104	114X0105	114X0107	OP-MCGC003TL	TL3GX	G	G	BG1	0,13	1	172	0,8	1/4"	1/4"
MBP	114X0108	114X0109	114X0111	OP-MCGC004TL	TL4GX	G	G	BG1	0,13	1	172	0,8	1/4"	1/4"
MBP	114X0301	114X0302	114X0303	OP-MCHC004TL	TL4DL	G	H	BG3	0,31	1	230	1,1	3/8"	1/4"
MBP	114X0112	114X0113	114X0115	OP-MCGC005TL	TL5GX	G	G	BG1	0,13	1	172	0,8	1/4"	1/4"
MBP	114X0200	114X0201	114X0203	OP-MCGC006FR	FR6GX	G	G	BG2	0,25	1	200	0,8	3/8"	1/4"
MBP	114X2316	114X2317	114X2319	OP-MCHC006FR	FR6DLX	G	H	BG3	0,31	1	230	1,1	3/8"	1/4"
MBP	114X0228			OP-MCGC006NL	NL6.1MF	G	G	BG2	0,25	1	200	0,8	3/8"	1/4"
MBP	114X0216	114X0217	114X0219	OP-MCGC007FR	FR7.5GX	G	G	BG2	0,25	1	200	0,8	3/8"	1/4"
MBP	114X0244			OP-MCGC007NL	NL7.3MF	G	G	BG2	0,25	1	200	0,8	3/8"	1/4"
MBP	114X2424	114X2425	114X2427	OP-MCHB007NF	NF7MLX	G	H	BG4/5	0,4	1	254	1,1	3/8"	1/4"
MBP	114X0224	114X0225	114X0227	OP-MCGC008FR	FR8.5GX	G	G	BG2	0,25	1	200	0,8	3/8"	1/4"
MBP	114X0204	114X0205		OP-MCGC008NL	NL8.4MF	G	G	BG2	0,25	1	200	0,8	3/8"	1/4"
MBP	114X0352			OP-MCGC008NL	NL8.4MF	G	G	BG3	0,31	1	230	-	3/8"	1/4"
MBP			114X0223	OP-MCGC010SC	SC10GX	G	G	BG2	0,25	1	200	0,8	3/8"	1/4"
MBP	114X0403	114X0404	114X0405	OP-MCHC010SC	SC10MLX	G	H	BG4/5	0,4	1	254	1,1	3/8"	1/4"
MBP	114X0336	114X0337	114X0339	OP-MCGC011FR	FR11GX	G	G	BG3	0,31	1	230	1,1	3/8"	1/4"
MBP	114X0340	114X0341	114X0343	OP-MCGC012SC	SC12GX	G	G	BG3	0,31	1	230	1,1	3/8"	1/4"
MBP	114X0406	114X0407	114X0408	OP-MCHC013SC	SC12MLX	G	H	BG4/5	0,4	1	254	1,1	3/8"	1/4"
MBP	114X0448	114X0449	114X0451	OP-MCGC015SC	SC15GX	G	G	BG4/5	0,4	1	254	1,1	3/8"	1/4"
MBP		114X2649	114X2651	OP-MCHC015SC	SC15MLX	G	H	BG6	1,1	1	300	1,1	1/2	1/4"
MBP	114X0556	114X0557	114X0559	OP-MCGC018SC	SC18G	G	G	BG4/5	0,4	1	254	1,1	3/8"	1/4"
MBP		114X0702	114X0703	OP-MCHC018SC	SC18MLX	G	H	BG7	0,84	1	300	1,1	1/2	1/4"
MBP	114X0568			OP-MCGC021SC	SC21MF	G	G	BG4/5	0,4	1	254	1,1	3/8"	1/4"
MBP	114X0564	114X0565	114X0567	OP-MCGC021SC	SC21GX	G	G	BG4/5	0,4	1	254	1,1	3/8"	1/4"
MBP		114X2765	114X2767	OP-MCHC021GS	GS21MLX	G	H	BG7	0,84	1	300	1,6	5/8	3/8"
MBP		114X0773		OP-MCGC026GS	GS26MFX	G	G	BG7	0,84	1	300	2,4	3/8"	1/4"
MBP		114X0781		OP-MCGC034GS	GS34MFX	G	G	BG7	0,84	1	300	2,4	1/2	3/8"

## Ohjeet

### R290 - Tekniset tiedot

Käyttökohde	Versio			Kuvaus	Kompressori	Sähkökoodi	Kylmäaine	Lauhdutinkenno		Puhallin		Varaajan tilavuus (L)	Imputki (mm)	Nesteputki (mm)
	A09	A10	A11					Tyypimerkintä	Sisäinen tilavuus (L)	Numero	Siipi (mm)			
LBP	114F0202	114F0203	114F0201	OP-LCNC004NU	NUY45LAb	G	N	BG2	0,25	1	200	0,114	6	6
LBP	114F0205	114F0206	114F0204	OP-LCNC006NU	NUT60CAe	G	N	BG2	0,25	1	200	0,114	6	6
LBP	114F0308	114F0309	114F0307	OP-LCNC008NU	NUY80LAb	G	N	BG3	0,31	1	230	0,114	6	6
LBP	114F0411	114F0412	114F0410	OP-LCNC011NY	NPY12LAb	G	N	BG4/5	0,4	1	254	0,165	8	6
LBP	114F0414	114F0415	114F0413	OP-LCNC016NP	NPT16LA	G	N	BG4/5	0,4	1	254	0,165	8	6
LBP	114F0417	114F0418	114F0416	OP-LCNC023NX	NX23FBa	G	N	BG4/5	0,4	1	254	0,165	10	6
LBP	114F0620	114F0621	114F0619	OP-LCNC034NS	NS34FB	G	N	BG6	0,63	1	300	0,32	12	6
MBP	114F1202	114F1203	114F1201	OP-MCNC003NB	NBC30RA	G	N	BG2	0,25	1	200	0,114	6	6
MBP	114F1205	114F1206	114F1204	OP-MCNC004NU	NUY45RAb	G	N	BG2	0,25	1	200	0,114	6	6
MBP	114F1308	114F1309	114F1307	OP-MCNC006NU	NUY60RAb	G	N	BG3	0,31	1	230	0,114	6	6
MBP	114F1411	114F1412	114F1410	OP-MCNC008NU	NUY80RAb	G	N	BG4/5	0,4	1	254	0,165	6	6
MBP	114F1414	114F1415	114F1413	OP-MCNC009NU	NUY90RAb	G	N	BG4/5	0,4	1	254	0,165	6	6
MBP	114F1417	114F1418	114F1416	OP-MCNC011NY	NLY12RAb	G	N	BG4/5	0,4	1	254	0,165	8	6
MBP	114F1420	114F1421	114F1419	OP-MCNC014NP	NPT14RA	G	N	BG4/5	0,4	1	254	0,165	8	6
MBP	114F1623	114F1624	114F1622	OP-MCNC016NP	NPT16RA	G	N	BG6	0,63	1	300	0,32	8	6
MBP	114F1626	114F1627	114F1625	OP-MCNC018NX	NX18TBa	G	N	BG6	0,63	1	300	0,32	10	6
MBP	114F1629	114F1630	114F1628	OP-MCNC020NX	NX21TBa	G	N	BG6	0,63	1	300	0,32	10	6

### Ei kuvasto - Tekniset tiedot

Käyttökohde	Versio					Kompressori	Kylmäaine	Lauhdutin	Puhallin		Varaajan tilavuus (L)
	T0	T1	T2	N0	N2				Numero	Halkaisija (mm)	
LBP	-	-	-	-	114G1600	TL3F	F	BG2	1	200	0,8
LBP	-	-	114E2471	114H1506	-	TL4CL	CL	BG1	1	170	0,8
LBP	-	-	-	114E2123 114E2227	114G1602	TL55F	F	BG1	1	170	0,8
LBP	-	-	114H2726	114E2454 114E2503	-	FR6CL	CL	BG2	1	200	0,8
LBP	-	-	-	114G1512	114G1612	NL9F	F	BG2	1	200	0,8
LBP	-	-	-	-	114G2613	NL11F	F	BG2	1	200	0,8
LBP	-	-	-	114E2603	-	NL8.4MF	MF	BG2	1	200	0,8
LBP	-	-	-	114E2577 114H3546	-	NL8.4CLX	CL	BG3	1	230	1,1
LBP	114E2593	114E2517	114H3728	-	-	FR8.5CL	CL	BG3	1	230	1,1
LBP	-	114E2156	114H3730	114E2198 114E2452 114E2534	-	SC10CL	CL	BG3	1	230	1,1
LBP	-	-	-	-	114G1611	NL7F	F	BG4/5	1	254	1,1
LBP	-	-	114H4731	-	-	SC12CL	CL	BG4/5	1	254	1,1
LBP	114E2536	-	114H5732	-	114E2361	SC15CL	CL	BG4/5	1	254	1,1
LBP	114E4007	-	114H5733	114H5533 114E2172	-	SC18CL	CL	BG4/5	1	254	1,1
LBP	114E2353 114E2555 114E4003	-	-	-	-	SC21CL	CL	BG4/5	1	254	1,1
LBP	-	-	114H6735 114H6335	-	-	SC10/10CL	CL	BG6	1	300	2,4
LBP	-	-	114H7736 114H7336 114F5052	-	-	SC12/12CL	CP	BG7	1	300	2,4
LBP	-	-	114H7337 114F5053 114H7737	-	-	SC15/15CL	CL	BG7	1	300	2,4
LBP	114E2546	-	114H7338 114H7738	-	-	SC18/18CL	CP	BG7	1	300	2,4
LBP	-	-	114H7339 114H7739	-	-	SC21/21CL	CP	BG7	1	300	2,4
MBP	-	-	-	114G0503	-	PL35G	G	BG0	1	172	-
MBP	-	-	-	114E2203 114G0502	-	PL50F	F	BG0	1	172	-
MBP	114B0017	-	-	-	-	BD250GH	G	BG0.5	1	172	-
MBP	-	-	114G1706	114G1506	114G1606	TL4G	G	BG1	1	170	0,8
MBP	114E2548	-	114G1708	114E2492 114E2541	-	TL5G	G	BG1	1	170	0,8
MBP	-	-	-	114B0006 114G1901	-	TL4GH	G	BG1	1	170	0,8
MBP	-	-	-	114G2515	114G2615	FR6G	G	BG2	1	200	0,8
MBP	-	-	-	114G2518	-	FR7.5G	G	BG2	1	200	0,8
MBP	114E2346	-	114G2716	114E2201 114E2332 114G2516	114G2616	FR8.5G	G	BG2	1	200	0,8
MBP	114E2410 114E2519 114E2522	-	-	114E2362	-	FR8.5G	G	BG2	1	200	0,8

## Ohjeet

### Ei kuvasto - Tekniset tiedot (jatkoa)

Käyttökohde	Versio					Kompressori	Kylmäaine	Lauhdutin	Puhallin		Varaajan tilavuus (L)
	T0	T1	T2	N0	N2				Numero	Halkaisija (mm)	
MBP		-	114G2719	-	-	FR10G	G	BG2	1	200	0,8
MBP	114E2347 114E2411 114E2520 114E2544	-	-	114E2333 114E2523	-	SC10G	G	BG2	1	200	0,8
MBP	-	-	114E2527 114H3727	-	-	FR6DL	DL	BG3	1	230	1,1
MBP	-	-	114G3717	114G3517	114G3617	FR11G	G	BG3	1	230	1,1
MBP	-	-	-	114G3536	-	NL10MF	MF	BG3	1	230	1,1
MBP	114E2351 114E2390 114E2549 114E2545 114E2457 114E2521	-	114G3726	114E2434 114G3526 114G9350 114G4565	114G3626	SC12G	G	BG3	1	230	1,1
MBP	-	-	114E2528 114H5743	-	-	SC10DL	DL	BG4/5	1	254	1,1
MBP	-	-	114H5744	-	-	SC12DL	DL	BG4/5	1	254	1,1
MBP	114E2352 114E2391 114E2550	-	114G4727	114E2435 114G4527	114G4627	SC15G	G	BG4/5	1	254	1,1
MBP	114E2442 114E2567 114E4023	-	114G5728	114E2357 114E2418 114G5528	-	SC18G	G	BG4/5	1	254	1,1
MBP	114E2459 114E2551	-	114G5730	114E2419 114G5530	-	SC21G	G	BG4/5	1	254	1,1
MBP	114E2540	-	114E2529 114H6745	-	-	SC15DL	DL	BG6	1	300	2,4
MBP	-	-	114E2586	-	-	SC15MLX	ML	BG6	1	300	2,4
MBP	-	-	114E2587	-	-	SC18MLX	ML	BG7	1	300	2,4
MBP	-	-	114G6380 114G6780	-	-	SC12/12G	G	BG6	1	300	2,4
MBP	-	-	114H7347 114H7747	-	-	SC10/10DL	DL	BG7	1	300	2,4
MBP	-	-	114H7348 114H7748	-	-	SC12/12DL	DL	BG7	1	300	2,4
MBP	-	-	114G7381 114G7781	-	-	SC15/15G	G	BG7	1	300	2,4
MBP	-	-	114H7349 114H7749	-	-	SC15/15DL	DL	BG7	1	300	2,4
MBP	114E2128	-	114G7382 114G7782	-	-	SC18/18G	G	BG7	1	300	2,4
MBP	114E2149	-	114G7383 114G7783	-	-	SC21/21G	G	BG7	1	300	2,4
LBP/MBP	-	-	-	114F1504	-	TL5CN	CN	BG1	1	170	-
LBP/MBP	-	-	-	114F1508	-	TL4CN	CN	BG1	1	170	-
LBP/MBP	-	-	-	114F2505	-	NL7CN	CN	BG2	1	200	-
LBP/MBP	-	-	-	114F3500	-	SC10CN	CN	BG3	1	230	-
LBP/MBP	-	-	-	114F3509	-	NL9CN	CN	BG2	1	200	-
LBP/MBP	-	-	-	114F4501	-	SC12CN	CN	BG4/5	1	254	-
LBP/MBP	-	-	-	114F4502	-	SC15CN	CN	BG4/5	1	254	-
LBP/MBP	-	-	-	114F4503	-	SC18CN	CN	BG4/5	1	254	-

Pyyntöistä Virtajohto lisätään muihin kuin kuvastomalleihin

### UL - Tekniset tiedot

Käyttökohde	Versio				Kompressori	Kylmäaine	Lauhdutin	Puhallin		Varaajan tilavuus (L)
	T0	T1	T2	N0				Numero	Halkaisija (mm)	
LBP			114G2573		NL11F	F	BG2	1	200	0,8
LBP	114E2403				SC10CLX	CL	BG3	1	230	1,2
LBP	114H4515		114E4018		SC12CL	CL	BG4/5	1	254	1,1
LBP				114H5953	SC18CLX	CL	BG4/5	1	254	1,1
LBP			114E2495		SC15CLX	CL	BG4/5	1	254	1,1
LBP			114E4024		SC15CLX	CL	BG4/5	1	254	1,1
LBP				114F5062	SC12/12CL	CL	BG4/5	1	254	1,1
LBP	114F0207 114F0208				DLE4.8CN	CN	BG2	1	200	0,8
MBP	114G1900	114G1660		114G1760 114G1940	TL4G	G	BG1	1	170	0,8
MBP			114E4020		FF8.5GX	G	BG3	1	230	1,2
MBP			114E4021	114G3768	FF10GX	G	BG3	1	230	1,2
MBP	114E2397		114E4022	114G3942	SC12G	G	BG3	1	230	1,2
MBP			114E4002		SC15G	G	BG4/5	1	254	1,1
MBP				114G5946	SC18GH	G	BG4/5	1	254	1,1

الملحق - "أ"، البيانات الفنية

معلومات الملصق

<b>Optyma™</b> by Danfoss			
EAN No :			MADE IN ITALY
<b>B</b> Serial No 29XXXXXXX		<b>A</b>	
<b>C</b> Refrigerant: (1) Rxxxx (2)		<b>D</b> 114X1219 <b>E</b> Model: XXXXXXXX	
Max. Working Pressure HP (1) xx		Comp: xxx-xxxV xxHz Fan: xxx-xxxV xxHz-xxHz Refr. Charge < 150g	
According with EN 378 and temperature 46°C			
If imported from UK - Danfoss Ltd., 22 Wycombe End, HP9 1NB, GB Імпортёр: ТОВ з іі "Данфосс ТОВ" 04080, Київ 80, п/с 168, Україна			

A: رقم رمز وحدة التكييف

B: الرقم التسلسلي للإنتاج

C: مادة التبريد

D: تعيين النموذج

E: مصدر الطاقة للضاغط ومحرك المروحة

التصميم - الكatalog

OP - LCQN 048 MT A00 E

8 7 6 5 4 3 2 1

OP = Optyma

Light Commercial R290			Light Commercial			
A11	A10	A09	A04	A01	A00	
تصل إلى 43 درجة مئوية			تصل إلى 43 درجة مئوية			درجة الحرارة المحيطة
NLY, NBC, NPT, NS, NX			MPT, MLY, NL, SC, GS, FR, TL, NF			منصة الضاغط الترددي محكم الإغلاق
القضبان أو لوحة القاعدة						قاعدة الوحدة
الزعنفة والأنبوب (مطلبتان)						نوع المكثف
EC	EC	EC	AC/EC	AC/EC	AC/EC	المروحة
-	-	نعم	نعم	نعم	-	دعامة وأنبوب لتركيب Pressostat
-	-	-	نعم	-	-	مفتاح الضغط المزدوج - KP 17 WB
نعم	نعم	نعم	-	-	-	صمام Schrader
نعم	نعم	نعم	نعم	نعم	نعم	الصندوق الكهربائي السلبي
-	نعم	-	-	-	-	Mini HP/LP Pressostat
-	نعم	-	نعم	-	-	سلك الطاقة
-	الجفف والمستقبل المجمعان	-	نعم	نعم	-	المستقبل

1	الاستخدام: M = الضغط الخلفي المتوسط؛ L = الضغط الخلفي المنخفض
2	منصة الضاغط: C: وحدة تكييف مبردة بالهواء مع مروحة واحدة
3	مادة التبريد: H: R404A/R507 ;G: R134a, R513A Q: R452A, R404A/R507 N: R290
4	تصميم المكثف: C: زعنفة وأنبوب المكثف. درجة حرارة محيطية تصل إلى 43 درجة مئوية
5	إزاحة الضاغط: على سبيل المثال 048 = 48 سم <sup>3</sup>
6	منصة الضاغط الترددية: FR = FR, NF = NF, SC = SC, GS = GS, NX = NX, NB = NBC, NS = NS NU = NUY, NP = NPT, MP = MPT, MY = MLY, MX = MX, TL = TL, NL = NL
7	الإصدار: A00, A01, A04, A09, A10, A11. انظر الجدول "نظرة عامة على الميزات". للتعرف على الميزات في كل إصدار.
8	الكود الكهربائي: G: ضاغط 230 فولت / مرحلة واحدة / 50 هرتز. المروحة 230 فولت / مرحلة واحدة / 50 هرتز E: الضاغط 400 فولت / 3 مراحل / 50 هرتز. المروحة 230 فولت / مرحلة واحدة / 50 هرتز

طرازات الكتالوج  
Light Commercial - البيانات الفنية

خط السائل	خط الشفط	حجم جهاز الاستقبال (L)	المروحة		ملف المكثف		مادة التبريد	الكود الكهربائي	المضاغط	الوصف	الإصدار			الإستخدام
			الشفرة (م)	الرقم	الحجم الداخلي (L)	التعيين					A04	A01	A00	
بوصة 1/4	بوصة 1/4	0.8	200	1	0.25	BG2	H	G	TL4CL	OP-LCHC004TL	114X1211	114X1209	114X1208	LBP
بوصة 1/4	بوصة 3/8	0.8	200	1	0.25	BG2	Q	G	MLY45LAb	OP-LCQC004ML		114X1221		LBP
بوصة 1/4	بوصة 3/8	0.8	200	1	0.25	BG2	H	G	FR6CL	OP-LCHC006FR	114X1219	114X1217	114X1216	LBP
بوصة 1/4	بوصة 3/8	1.1	230	1	0.31	BG3	Q	G	MLY60LAb	OP-LCQC006ML		114X1337		LBP
بوصة 1/4	بوصة 3/8	1.1	230	1	0.31	BG3	H	G	NL7CLX	OP-LCHC007NL	114X1331	114X1329	114X1328	LBP
بوصة 1/4	بوصة 3/8	1.1	230	1	0.31	BG3	H	G	FR8.5CL	OP-LCHC008FR	114X1327	114X1325	114X1324	LBP
بوصة 1/4	بوصة 3/8	1.1	230	1	0.31	BG3	H	G	NL8.4CLX	OP-LCHC008NL	114X1302	114X1301	114X1304	LBP
بوصة 1/4	بوصة 3/8	1.1	230	1	0.31	BG3	Q	G	MLY80LAb	OP-LCQC008ML		114X1341		LBP
بوصة 1/4	بوصة 3/8	1.1	254	1	0.4	BG4/5	H	G	SC12CL	OP-LCHC012SC	114X1443	114X1441	114X1440	LBP
بوصة 1/4	بوصة 3/8	1.1	254	1	0.4	BG4/5	H	G	SC12CLX.2	OP-LCHC012SC			114X1444	LBP
بوصة 1/4	بوصة 3/8	1.1	254	1	0.4	BG4/5	Q	G	MLY12LAb	OP-LCQC012ML		114X1449		LBP
بوصة 1/4	بوصة 3/8	1.1	254	1	0.4	BG4/5	Q	G	MPT12LA	OP-LCQC012MP		114X1569		LBP
بوصة 1/4	بوصة 1/2	1.1	254	1	0.4	BG4/5	Q	G	MPT14LA	OP-LCQC014MP		114X1573		LBP
بوصة 1/4	بوصة 3/8	1.1	254	1	0.4	BG4/5	H	G	SC15CLX	OP-LCHC015SC	114X1551	114X1549	114X1548	LBP
بوصة 1/4	بوصة 1/2	1.1	254	1	0.4	BG4/5	H	G	SC18CL	OP-LCHC018SC	114X1559	114X1557	114X1556	LBP
بوصة 1/4	بوصة 1/2	1.1	300	1	0.63	BG6	H	G	SC21CL	OP-LCHC021SC	114X1602	114X1601	114X1600	LBP
بوصة 3/8	بوصة 1/2	2.4	300	1	0.63	BG6	H	G	GS26CLX	OP-LCHC026GS		114X1673		LBP
بوصة 3/8	بوصة 1/2	2.4	300	1	0.84	BG7	H	G	GS34CLX	OP-LCHC034GS	114X1783	114X1781		LBP
بوصة 1/4	بوصة 1/4	0.8	172	1	0.13	BG1	G	G	TL3GX	OP-MCGC003TL	114X0107	114X0105	114X0104	MBP
بوصة 1/4	بوصة 1/4	0.8	172	1	0.13	BG1	G	G	TL4GX	OP-MCGC004TL	114X0111	114X0109	114X0108	MBP
بوصة 1/4	بوصة 3/8	1.1	230	1	0.31	BG3	H	G	TL4DL	OP-MCHC004TL	114X0303	114X0302	114X0301	MBP
بوصة 1/4	بوصة 1/4	0.8	172	1	0.13	BG1	G	G	TL5GX	OP-MCGC005TL	114X0115	114X0113	114X0112	MBP
بوصة 1/4	بوصة 3/8	0.8	200	1	0.25	BG2	G	G	FR6GX	OP-MCGC006FR	114X0203	114X0201	114X0200	MBP
بوصة 1/4	بوصة 3/8	1.1	230	1	0.31	BG3	H	G	FR6DLX	OP-MCHC006FR	114X2319	114X2317	114X2316	MBP
بوصة 1/4	بوصة 3/8	0.8	200	1	0.25	BG2	G	G	NL6.1MF	OP-MCGC006NL			114X0228	MBP
بوصة 1/4	بوصة 3/8	0.8	200	1	0.25	BG2	G	G	FR7.5GX	OP-MCGC007FR	114X0219	114X0217	114X0216	MBP
بوصة 1/4	بوصة 3/8	0.8	200	1	0.25	BG2	G	G	NL7.3MF	OP-MCGC007NL			114X0244	MBP
بوصة 1/4	بوصة 3/8	1.1	254	1	0.4	BG4/5	H	G	NF7MLX	OP-MCHB007NF	114X2427	114X2425	114X2424	MBP
بوصة 1/4	بوصة 3/8	0.8	200	1	0.25	BG2	G	G	FR8.5GX	OP-MCGC008FR	114X0227	114X0225	114X0224	MBP
بوصة 1/4	بوصة 3/8	0.8	200	1	0.25	BG2	G	G	NL8.4MF	OP-MCGC008NL		114X0205	114X0204	MBP
بوصة 1/4	بوصة 3/8	-	230	1	0.31	BG3	G	G	NL8.4MF	OP-MCGC008NL			114X0352	MBP
بوصة 1/4	بوصة 3/8	0.8	200	1	0.25	BG2	G	G	SC10GX	OP-MCGC010SC	114X0223			MBP
بوصة 1/4	بوصة 3/8	1.1	254	1	0.4	BG4/5	H	G	SC10MLX	OP-MCHC010SC	114X0405	114X0404	114X0403	MBP
بوصة 1/4	بوصة 3/8	1.1	230	1	0.31	BG3	G	G	FR11GX	OP-MCGC011FR	114X0339	114X0337	114X0336	MBP
بوصة 1/4	بوصة 3/8	1.1	230	1	0.31	BG3	G	G	SC12GX	OP-MCGC012SC	114X0343	114X0341	114X0340	MBP
بوصة 1/4	بوصة 3/8	1.1	254	1	0.4	BG4/5	H	G	SC12MLX	OP-MCHC013SC	114X0408	114X0407	114X0406	MBP
بوصة 1/4	بوصة 3/8	1.1	254	1	0.4	BG4/5	G	G	SC15GX	OP-MCGC015SC	114X0451	114X0449	114X0448	MBP
بوصة 1/4	بوصة 1/2	1.1	300	1	1.1	BG6	H	G	SC15MLX	OP-MCHC015SC	114X2651	114X2649		MBP
بوصة 1/4	بوصة 3/8	1.1	254	1	0.4	BG4/5	G	G	SC18G	OP-MCGC018SC	114X0559	114X0557	114X0556	MBP
بوصة 1/4	بوصة 1/2	1.1	300	1	0.84	BG7	H	G	SC18MLX	OP-MCHC018SC	114X0703	114X0702		MBP
بوصة 1/4	بوصة 3/8	1.1	254	1	0.4	BG4/5	G	G	SC21MF	OP-MCGC021SC			114X0568	MBP
بوصة 1/4	بوصة 3/8	1.1	254	1	0.4	BG4/5	G	G	SC21GX	OP-MCGC021SC	114X0567	114X0565	114X0564	MBP
بوصة 3/8	بوصة 5/8	1.6	300	1	0.84	BG7	H	G	GS21MLX	OP-MCHC021GS	114X2767	114X2765		MBP
بوصة 1/4	بوصة 3/8	2.4	300	1	0.84	BG7	G	G	GS26MFX	OP-MCGC026GS		114X0773		MBP
بوصة 3/8	بوصة 1/2	2.4	300	1	0.84	BG7	G	G	GS34MFX	OP-MCGC034GS		114X0781		MBP

SC 18 G X T2

T T T T T  
1 2 3 4 5

Light Commercial					
T2	T1	T0	N2	N1	N0
نصل إلى 43 درجة مئوية					
NL, SC, GS, FR, TL, NF, DL					
القضبان أو لوحة القاعدة					
الزعنفة والأنبوب (مطلبتان)					
نعم	نعم	نعم	-	-	-
Schrader صمام					
نعم	نعم	نعم	نعم	نعم	نعم
الصندوق الكهربائي السلبي					
نعم	*نعم	-	نعم	*نعم	-
صمام الخدمة					
نعم	نعم	نعم	-	-	-
المستقبل					

(\* صمام خدمة واحد

1	منصة الضاغط: PL, TL, NL, FR, SC, GS
2	إراحة الضاغط: على سبيل المثال 048 = 48 سم <sup>3</sup> الاستخدام ومادة التبريد: R22 :CM = LBP R404A/R507 :CL = LBP R290 :CN = LBP/MBP R404A/R507, R452A :CP = LBP R22 :DM = HBP R404A/R507 :DL = HBP R134a :F = LBP/MBP R134a :FT = LBP tropical R513A و R134a :G = LBP/MBP/HBP R134a :GH = تحسين مضخة الحرارة; R134a :MF = MBP R404A/507 :ML = MBP
3	
4	خصائص بدء التشغيل: X = HST K = LST
5	الإصدار: N0 - للأنيوب الشعري - بدون صمامات إيقاف. بدون مستقبل N1 - للأنيوب الشعري - مع صمام إيقاف واحد. بدون مستقبل N2 - للأنيوب الشعري - مع صمامي إيقاف. بدون مستقبل T0 - لصمام التمدد - مع مستقبل بدون صمامي إيقاف T1 - لصمام التمدد - مع مستقبل مع صمام إيقاف واحد T2 - لصمام التمدد - مع مستقبل مع صمامي إيقاف

خارج الكتلوج - البيانات الفنية (بتبع)

حجم جهاز الاستقبال (L)	المروحة		المكثف	مادة التبريد	الضاغط	الإصدار					الاستخدام
	القطر (م)	الرقم				N2	N0	T2	T1	T0	
0.8	200	1	BG2	G	FR10G	-	-	114G2719	-	-	MBP
0.8	200	1	BG2	G	SC10G	-	114E2333 114E2523	-	-	114E2347 114E2411 114E2520 114E2544	MBP
1.1	230	1	BG3	DL	FR6DL	-	-	114E2527 114H3727	-	-	MBP
1.1	230	1	BG3	G	FR11G	114G3617	114G3517	114G3717	-	-	MBP
1.1	230	1	BG3	MF	NL10MF	-	114G3536	-	-	-	MBP
1.1	230	1	BG3	G	SC12G	114G3626	114E2434 114G3526 114G9350 114G4565	114G3726	-	114E2351 114E2390 114E2549 114E2545 114E2457 114E2521	MBP
1.1	254	1	BG4/5	DL	SC10DL	-	-	114E2528 114H5743	-	-	MBP
1.1	254	1	BG4/5	DL	SC12DL	-	-	114H5744	-	-	MBP
1.1	254	1	BG4/5	G	SC15G	114G4627	114E2435 114G4527	114G4727	-	114E2352 114E2391 114E2550	MBP
1.1	254	1	BG4/5	G	SC18G	-	114E2357 114E2418 114G5528	114G5728	-	114E2442 114E2567 114E4023	MBP
1.1	254	1	BG4/5	G	SC21G	-	114E2419 114G5530	114G5730	-	114E2459 114E2551	MBP
2.4	300	1	BG6	DL	SC15DL	-	-	114E2529 114H6745	-	114E2540	MBP
2.4	300	1	BG6	ML	SC15MLX	-	-	114E2586	-	-	MBP
2.4	300	1	BG7	ML	SC18MLX	-	-	114E2587	-	-	MBP
2.4	300	1	BG6	G	SC12/12G	-	-	114G6380 114G6780	-	-	MBP
2.4	300	1	BG7	DL	SC10/10DL	-	-	114H7347 114H7747	-	-	MBP
2.4	300	1	BG7	DL	SC12/12DL	-	-	114H7348 114H7748	-	-	MBP
2.4	300	1	BG7	G	SC15/15G	-	-	114G7381 114G7781	-	-	MBP
2.4	300	1	BG7	DL	SC15/15DL	-	-	114H7349 114H7749	-	-	MBP
2.4	300	1	BG7	G	SC18/18G	-	-	114G7382 114G7782	-	114E2128	MBP
2.4	300	1	BG7	G	SC21/21G	-	-	114G7383 114G7783	-	114E2149	MBP
-	170	1	BG1	CN	TL5CN	-	114F1504	-	-	-	LBP/MBP
-	170	1	BG1	CN	TL4CN	-	114F1508	-	-	-	LBP/MBP
-	200	1	BG2	CN	NL7CN	-	114F2505	-	-	-	LBP/MBP
-	230	1	BG3	CN	SC10CN	-	114F3500	-	-	-	LBP/MBP
-	200	1	BG2	CN	NL9CN	-	114F3509	-	-	-	LBP/MBP
-	254	1	BG4/5	CN	SC12CN	-	114F4501	-	-	-	LBP/MBP
-	254	1	BG4/5	CN	SC15CN	-	114F4502	-	-	-	LBP/MBP
-	254	1	BG4/5	CN	SC18CN	-	114F4503	-	-	-	LBP/MBP

بناءً على الطلب. تمت إضافة سلك الطاقة إلى الطرز غير الموجودة في الكتلوج

UL - البيانات الفنية

حجم جهاز الاستقبال (L)	المروحة		المكثف	مادة التبريد	الضاغط	الإصدار				الاستخدام	
	القطر (م)	الرقم				N0	T2	T1	T0		
0.8	200	1	BG2	F	NL11F	-	114G2573	-	-	-	LBP
1.2	230	1	BG3	CL	SC10CLX	-	-	-	-	114E2403	LBP
1.1	254	1	BG4/5	CL	SC12CL	-	114E4018	-	-	114H4515	LBP
1.1	254	1	BG4/5	CL	SC18CLX	114H5953	-	-	-	-	LBP
1.1	254	1	BG4/5	CL	SC15CLX	-	114E2495	-	-	-	LBP
1.1	254	1	BG4/5	CL	SC15CLX	-	114E4024	-	-	-	LBP
1.1	254	1	BG4/5	CL	SC12/12CL	114F5062	-	-	-	-	LBP
0.8	200	1	BG2	CN	DLE4.8CN	-	-	-	-	114F0207 114F0208	LBP
0.8	170	1	BG1	G	TL4G	114G1760 114G1940	-	114G1660	-	114G1900	MBP
1.2	230	1	BG3	G	FF8.5GX	-	114E4020	-	-	-	MBP
1.2	230	1	BG3	G	FF10GX	114G3768	114E4021	-	-	-	MBP
1.2	230	1	BG3	G	SC12G	114G3942	114E4022	-	-	114E2397	MBP
1.1	254	1	BG4/5	G	SC15G	-	114E4002	-	-	-	MBP
1.1	254	1	BG4/5	G	SC18GH	114G5946	-	-	-	-	MBP



التعليقات

R290 - البيانات الفنية

خط السائل (م)	خط الضغط (م)	حجم جهاز الاستقبال (L)	المروحة		ملف المكثف		مادة التبريد	الكود الكهربائي	الضغوط	الوصف	الإصدار			الاستخدام
			الشفرة (م)	الرقم	الحجم الداخلي (L)	التعيين					A11	A10	A09	
6	6	0.114	200	1	0.25	BG2	N	G	NUY45Lab	OP-LCNC004NU	114F0201	114F0203	114F0202	LBP
6	6	0.114	200	1	0.25	BG2	N	G	NUT60CAe	OP-LCNC006NU	114F0204	114F0206	114F0205	LBP
6	6	0.114	230	1	0.31	BG3	N	G	NUY80Lab	OP-LCNC008NU	114F0307	114F0309	114F0308	LBP
6	8	0.165	254	1	0.4	BG4/5	N	G	NPY12Lab	OP-LCNC011NY	114F0410	114F0412	114F0411	LBP
6	8	0.165	254	1	0.4	BG4/5	N	G	NPT16LA	OP-LCNC016NP	114F0413	114F0415	114F0414	LBP
6	10	0.165	254	1	0.4	BG4/5	N	G	NX23FBa	OP-LCNC023NX	114F0416	114F0418	114F0417	LBP
6	12	0.32	300	1	0.63	BG6	N	G	NS34FB	OP-LCNC034NS	114F0619	114F0621	114F0620	LBP
6	6	0.114	200	1	0.25	BG2	N	G	NBC30RA	OP-MCNC003NB	114F1201	114F1203	114F1202	MBP
6	6	0.114	200	1	0.25	BG2	N	G	NUY45Rab	OP-MCNC004NU	114F1204	114F1206	114F1205	MBP
6	6	0.114	230	1	0.31	BG3	N	G	NUY60Rab	OP-MCNC006NU	114F1307	114F1309	114F1308	MBP
6	6	0.165	254	1	0.4	BG4/5	N	G	NUY80Rab	OP-MCNC008NU	114F1410	114F1412	114F1411	MBP
6	6	0.165	254	1	0.4	BG4/5	N	G	NUY90Rab	OP-MCNC009NU	114F1413	114F1415	114F1414	MBP
6	8	0.165	254	1	0.4	BG4/5	N	G	NLY12Rab	OP-MCNC011NY	114F1416	114F1418	114F1417	MBP
6	8	0.165	254	1	0.4	BG4/5	N	G	NPT14RA	OP-MCNC014NP	114F1419	114F1421	114F1420	MBP
6	8	0.32	300	1	0.63	BG6	N	G	NPT16RA	OP-MCNC016NP	114F1622	114F1624	114F1623	MBP
6	10	0.32	300	1	0.63	BG6	N	G	NX18TBa	OP-MCNC018NX	114F1625	114F1627	114F1626	MBP
6	10	0.32	300	1	0.63	BG6	N	G	NX21TBa	OP-MCNC020NX	114F1628	114F1630	114F1629	MBP

خارج الكتلوج - البيانات الفنية

حجم جهاز الاستقبال (L)	المروحة		المكثف	مادة التبريد	الضغوط	الإصدار					الاستخدام
	الفطر (م)	الرقم				N2	N0	T2	T1	T0	
0.8	200	1	BG2	F	TL3F	114G1600	-	-	-	-	LBP
0.8	170	1	BG1	CL	TL4CL	-	114H1506	114E2471	-	-	LBP
0.8	170	1	BG1	F	TL5SF	114G1602	114E2123 114E2227	-	-	-	LBP
0.8	200	1	BG2	CL	FR6CL	-	114E2454 114E2503	114H2726	-	-	LBP
0.8	200	1	BG2	F	NL9F	114G1612	114G1512	-	-	-	LBP
0.8	200	1	BG2	F	NL11F	114G2613	-	-	-	-	LBP
0.8	200	1	BG2	MF	NL8.4MF	-	114E2603	-	-	-	LBP
1.1	230	1	BG3	CL	NL8.4CLX	-	114E2577 114H3546	-	-	-	LBP
1.1	230	1	BG3	CL	FR8.5CL	-	-	114H3728	114E2517	114E2593	LBP
1.1	230	1	BG3	CL	SC10CL	-	114E2198 114E2452 114E2534	114H3730	114E2156	-	LBP
1.1	254	1	BG4/5	F	NL7F	114G1611	-	-	-	-	LBP
1.1	254	1	BG4/5	CL	SC12CL	-	-	114H4731	-	-	LBP
1.1	254	1	BG4/5	CL	SC15CL	114E2361	-	114H5732	-	114E2536	LBP
1.1	254	1	BG4/5	CL	SC18CL	-	114H5533 114E2172	114H5733	-	114E4007	LBP
1.1	254	1	BG4/5	CL	SC21CL	-	-	-	-	114E2353 114E2555 114E4003	LBP
2.4	300	1	BG6	CL	SC10/10CL	-	-	114H6735 114H6335	-	-	LBP
2.4	300	1	BG7	CP	SC12/12CL	-	-	114H7736 114H7336 114F5052	-	-	LBP
2.4	300	1	BG7	CL	SC15/15CL	-	-	114H7337 114F5053 114H7737	-	-	LBP
2.4	300	1	BG7	CP	SC18/18CL	-	-	114H7338 114H7738	-	114E2546	LBP
2.4	300	1	BG7	CP	SC21/21CL	-	-	114H7339 114H7739	-	-	LBP
-	172	1	BG0	G	PL35G	-	114G0503	-	-	-	MBP
-	172	1	BG0	F	PL50F	-	114E2203 114G0502	-	-	-	MBP
-	172	1	BG0.5	G	BD250GH	-	-	-	-	114B0017	MBP
0.8	170	1	BG1	G	TL4G	114G1606	114G1506	114G1706	-	-	MBP
0.8	170	1	BG1	G	TL5G	-	114E2492 114E2541	114G1708	-	114E2548	MBP
0.8	170	1	BG1	G	TL4GH	-	114B0006 114G1901	-	-	-	MBP
0.8	200	1	BG2	G	FR6G	114G2615	114G2515	-	-	-	MBP
0.8	200	1	BG2	G	FR7.5G	-	114G2518	-	-	-	MBP
0.8	200	1	BG2	G	FR8.5G	114G2616	114E2201 114E2332 114G2516	114G2716	-	114E2346	MBP
0.8	200	1	BG2	G	FR8.5G	-	114E2362	-	-	114E2410 114E2519 114E2522	MBP

**Instructions**

**Annex - B, KP switch settings**

**KP 15, 15A, 17W, 17B**

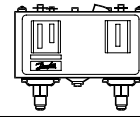

SPDT + LP signal

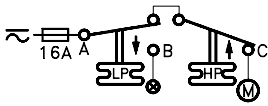

LP + HP signal

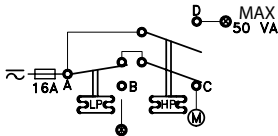

**UL** Listed refrigeration controller 61B5

Contacts	Voltage AC	DC	FL A	LR A	Resist. load	Pilot duty
A-B	240		8	48	8 A	3 A
A-C	120		16	96	16 A	
		240				12 W
A-D	240					50 VA

Use copper wire only  
Tightening torque 20lb. in.

When used acc. to UL regulations

LR 112A	AC1 16 A	400 V ?	DC 11
	AC3 16 A		12 W
	AC11 10 A		220 V ?

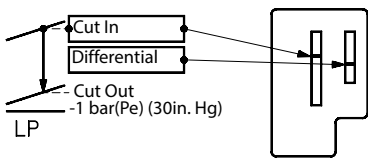

LP, aut. reset

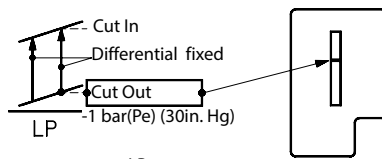

LP, man. reset

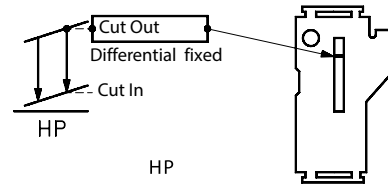

HP

Manual test

Manuel reset

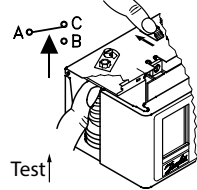

Test ↓

Manuel reset

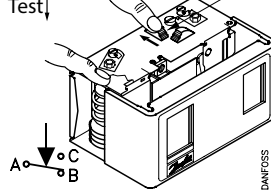

Convertible reset

KP 15 060-1154, 060-1220, 060-1261, 060-1263, 060-1283

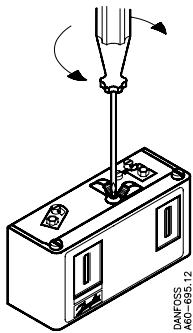

DANFOSS  
A60-695.12

Factory setting

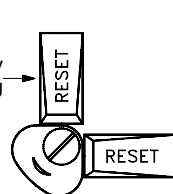

LP - man.  
HP - man.

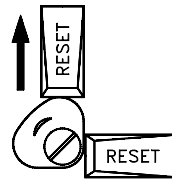

LP - auto  
HP - man.

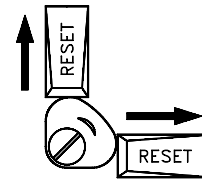

LP - auto  
HP - auto

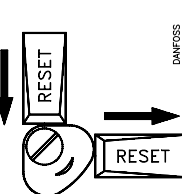

LP - man.  
HP - auto

DANFOSS  
A60-783.10

Convertible reset

KP 17B 060-539366, 060-539466

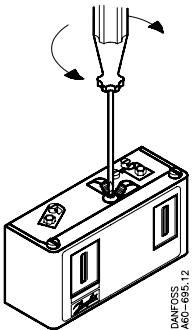

DANFOSS  
A60-695.12



LP - auto  
HP - man.



LP - auto  
HP - auto

LP diff.

360° ⊖ ⊕ =  
0.15 bar(2psi)

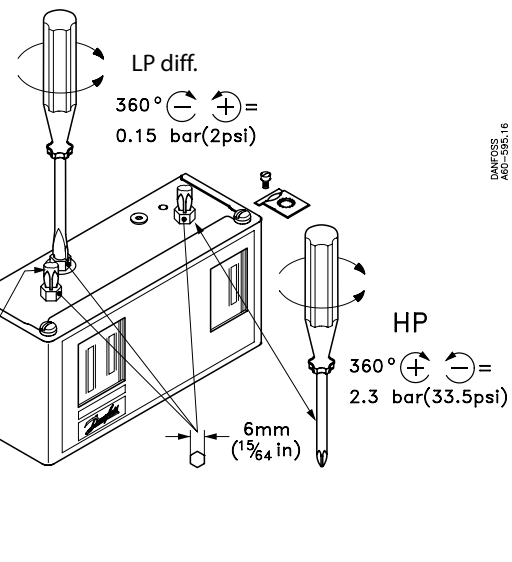

DANFOSS  
A60-385.16

LP  
360° ⊕ ⊖ =  
0.7 bar(10psi)

HP

360° ⊕ ⊖ =  
2.3 bar(33.5psi)

6mm  
(15/64 in)

Instructions

**KP 15, 15A, 17W, 17B, 17 WB**

KP 15, 17W, 17B, 17 WB: CFC, HFC, HCFC  
 KP 15A: R 717 (NH<sub>3</sub>)

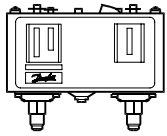
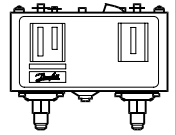

KP 15, 17

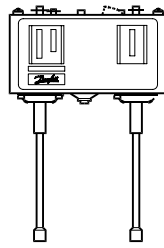

KP 15, 17

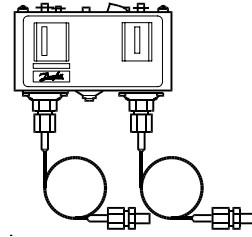

KP 15A

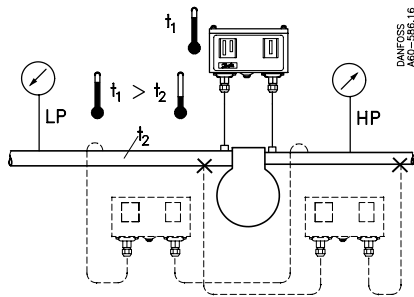

$t_1$  min. KP 15:  $-40^{\circ}\text{F}$  ( $-40^{\circ}\text{C}$ )  
 KP 17:  $-25^{\circ}\text{C}$  ( $-13^{\circ}\text{F}$ )  
 $t_1$  max.  $65^{\circ}\text{C}$  ( $150^{\circ}\text{F}$ )

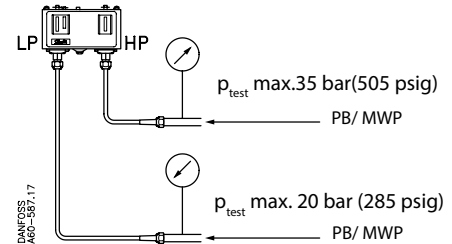

Type	Range	PB	MWP
KP 15	LP: $-0.2 \rightarrow 7.5$ bar	17 bar	250 psi
	HP: $8 \rightarrow 32$ bar	35 bar	505 psi
KP 15	LP: $-0.9 \rightarrow 7$ bar	17 bar	250 psi
	HP: $8 \rightarrow 32$ bar	35 bar	505 psi
Reset KP 17	LP: $-0.2 \rightarrow 7.5$ bar	17 bar	250 psi
	HP: $8 \rightarrow 32$ bar	35 bar	505 psi

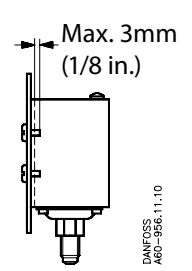
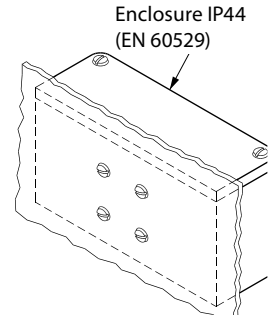
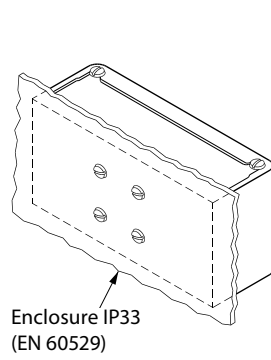
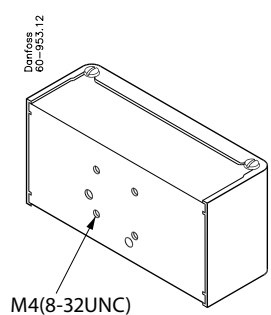
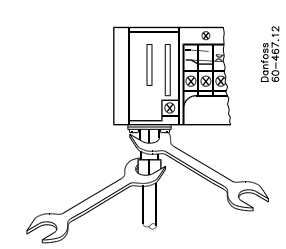
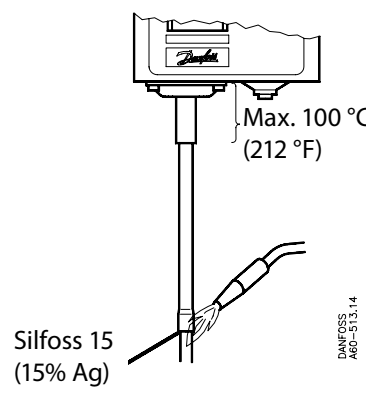
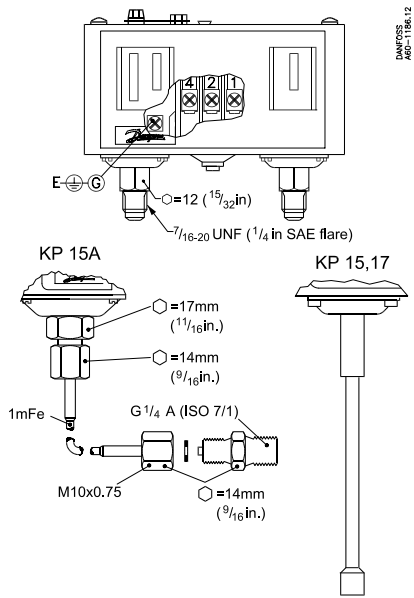

# Instructions

## SPDT + LP signal

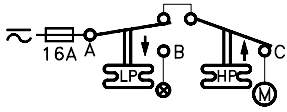

## LP + HP signal

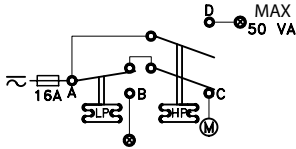

When used acc. to UL regulations

**UL US Listed refrigeration controller 61B5**

Contacts	Voltage	FL	LR	Resist. load	Pilot duty
A-B	240 AC	8 A	48 A	8 A	3 A
A-C	120 AC	16 A	96 A	16 A	
	240 DC				12 W
A-D	240 AC				50 VA

Use copper wire only  
Tightening torque 20lb. in.

LR 112A	AC1 16 A	400 V~	DC 11
	AC3 16 A		12 W
	AC11 10 A		220 V~

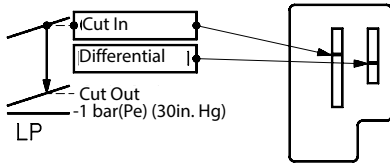

LP, aut. reset

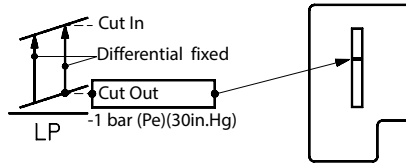

LP, man. reset

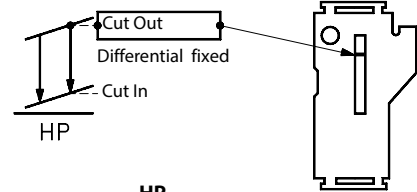

HP

## Manual test

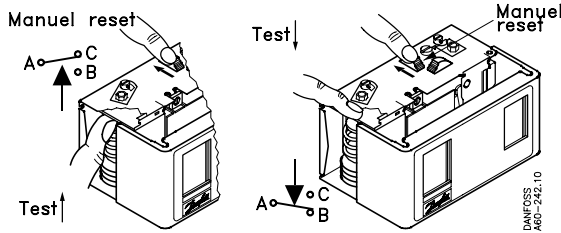

## Convertible reset

KP 15 - LP/HP convertible, KP17WB - HP convertible

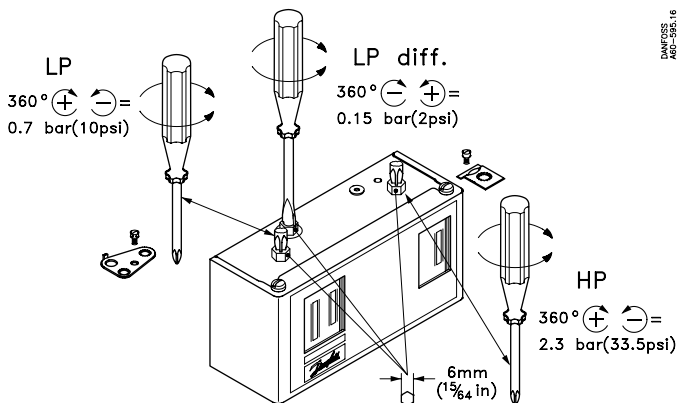
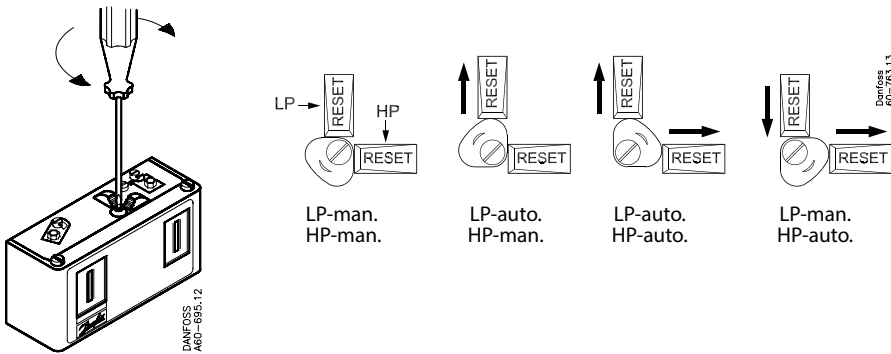

# Anleitungen

## Bilag – B, KP-pressostatindstillinger

### KP 15, 15A, 17W, 17B

**SPDT + LP signal**

**LP- og HP-signal**

**UL Anført køleregulator 61B5**

Kon-takter	Spænding AC   DC	FL A	LR A	Resist. belast-ning	Styre-strøm
A-B	240	8	48	8 A	3 A
A-C	120	16	96	16 A	12 W
A-D	240				50 VA

Brug kun kobberledning  
Tilspændingsmoment 20 lb. in.

Ved brug i henhold til UL-bestemmelserne

LR 112A	AC1 16 A	DC 11
	AC3 16 A	12 W
	AC11 10 A	220 V ?

**LP, aut. nulstil**

**LP, man. nulstil**

**HP**

**Manuel nulstilling**

**Manuel nulstilling**

**Konvertibel reset**  
KP 15 060-1154, 060-1220, 060-1261, 060-1263, 060-1283

**Konvertibel reset**  
KP 17B 060-539366, 060-539466

# Anleitungen

## KP 15, 15A, 17W, 17B, 17 WB

KP 15, 17W, 17B, 17 WB: CFC, HFC, HCFC  
 KP 15A: R 717 (NH<sub>3</sub>)

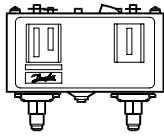
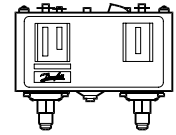

KP 15, 17

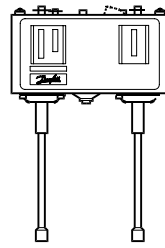

KP 15, 17

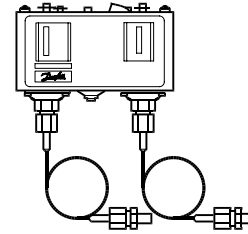

KP 15A

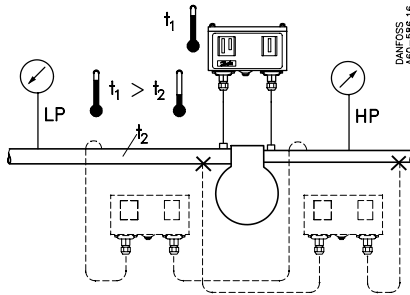

$t_1$  min. KP 15: -40 °F (-40 °C)  
 KP 17: -25 °C (-13 °F)  
 $t_1$  maks. 65 °C (150 °F)

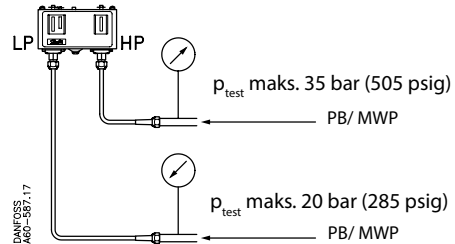

Type	Område	PB	MWP
KP 15	LP: -0,2 → 7,5 bar	17 bar	250 psi
	HP: 8 → 32 bar	35 bar	505 psi
KP 15	LP: -0,9 → 7 bar	17 bar	250 psi
	HP: 8 → 32 bar	35 bar	505 psi
Reset KP 17	LP: -0,2 → 7,5 bar	17 bar	250 psi
	HP: 8 → 32 bar	35 bar	505 psi

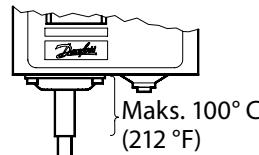
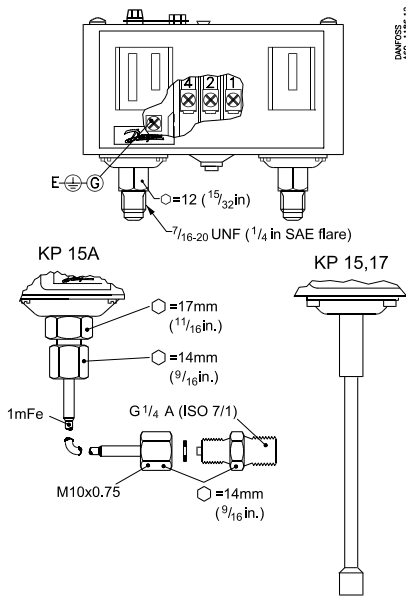

Silfoss 15  
(15 % Ag)

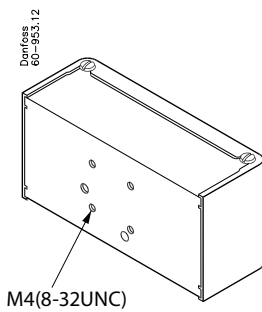
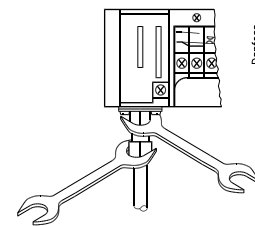

M4(8-32UNC)

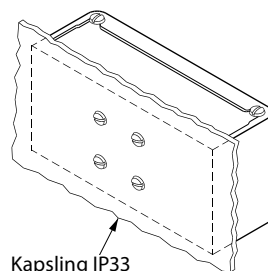

Kapsling IP33  
(EN 60529)

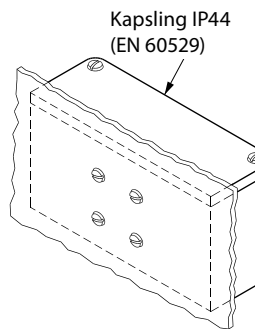

Kapsling IP44  
(EN 60529)

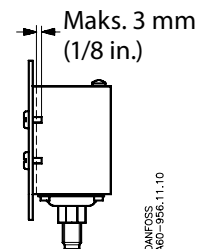

Maks. 3 mm  
(1/8 in.)

# Anleitungen

SPDT + LP signal

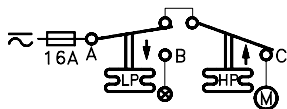

LP- og HP-signal

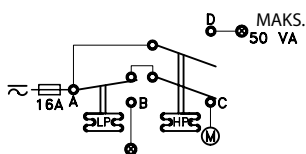

Ved brug i henhold til UL-bestemmelserne

**UL** **US** Anført køling regulator  
61B5

Kon-takter	Spænding	FL	LR	Resist. belastning	Styre-strøm
A-B	240	8	48	8A	3A
A-C	120	16	96	16A	
	240				12W
A-D	240				50VA

Brug kun kobberledning  
Tilspændingsmoment 20 lb. in.

LR 112A	AC1	16 A	400 V~	DC 11
	AC3	16 A		12 W
	AC11	10 A		220 V~

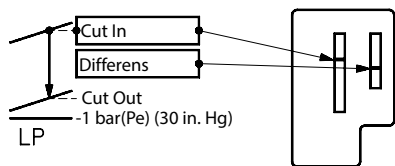

LP, aut. nulstil

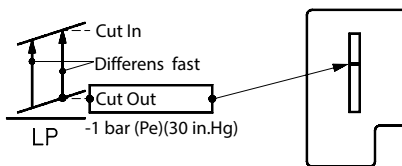

LP, man. nulstil

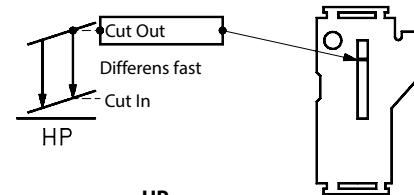

HP

## Manuel nulstilling

Manuel nulstilling

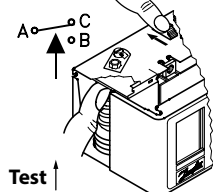

Test

Manuel nulstilling

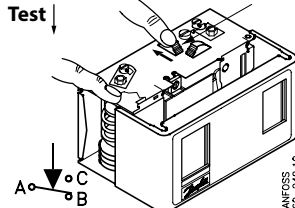

## Konvertibel reset

KP 15 - LP/HP konvertibel, KP17WB - HP konvertibel

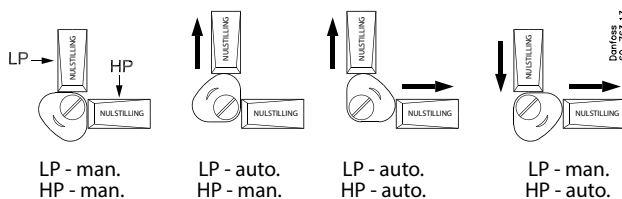
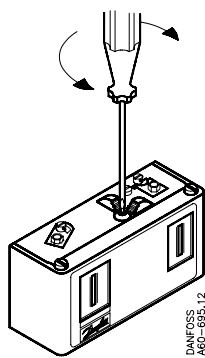

LP  
360° ⊕ ⊖ =  
0.7 bar(10psi)

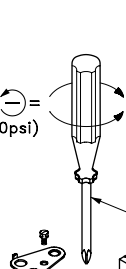

LP diff.  
360° ⊕ ⊖ =  
0.15 bar(2psi)

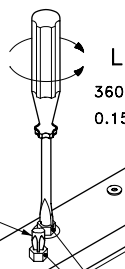

HP  
360° ⊕ ⊖ =  
2.3 bar(33.5psi)

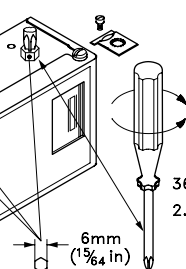

Anhang – B, KP Schaltereinstellungen

KP 15, 15A, 17W, 17B

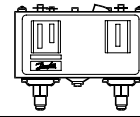

SPDT+ND-Signal

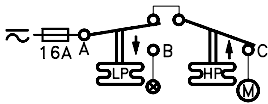

ND- und HD-Signal

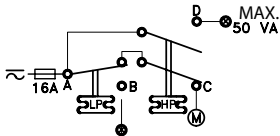

**UL** US **Gelistete Kühlstellenregler**  
61B5

Kon- tak- te	Spannung		FL A	LR A	Wider- stands- last	Pilotan- wendung
	AC	DC				
A-B	240		8	48	8 A	3 A
A-C	120		16	96	16 A	
		240				12 W
A-D	240					50 VA

Nur Kupferdraht verwenden  
Anzugsdrehmoment 2,26 Nm

Bei Verwendung gemäß UL-Vorschriften

LR 112A	AC1 16 A	DC 11
	AC3 16 A	12 W
	AC11 10 A	220 V ?

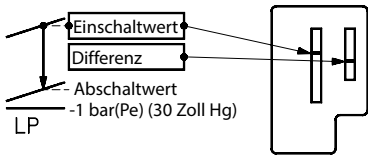

ND, aut. Zurücksetzen

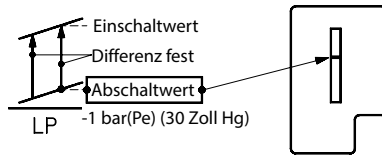

ND, man. Zurücksetzen

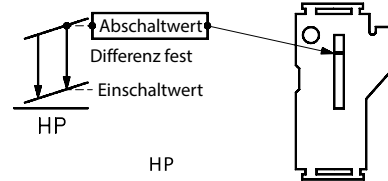

HP

Manuelles Zurücksetzen

Manueller Test

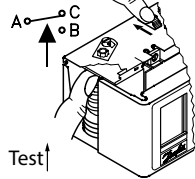

Manuelles Zurücksetzen

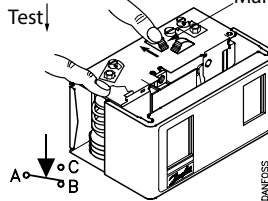

Umstellbarer Reset

KP 15 060-1154, 060-1220, 060-1261, 060-1263, 060-1283

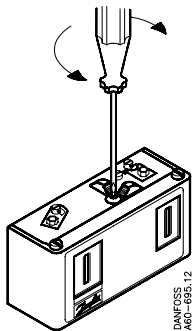

Werk-  
einstellung

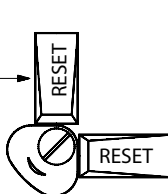

ND – man.  
HD – man.

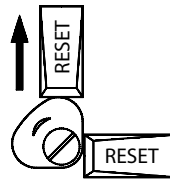

ND – auto  
HD – man.

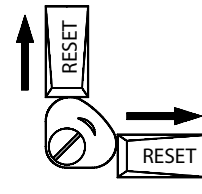

ND – auto  
HD – auto

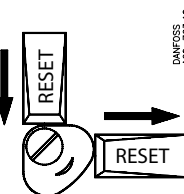

ND – man.  
HD – auto

Umstellbarer Reset

KP 17B 060-539366, 060-539466

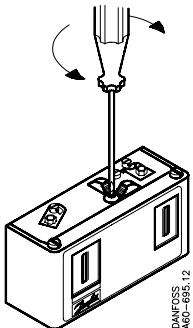

ND – auto  
HD – man.



ND – auto  
HD – auto

ND Diff.

360°  $\ominus$   $\oplus$  =  
0.15 bar(2psi)

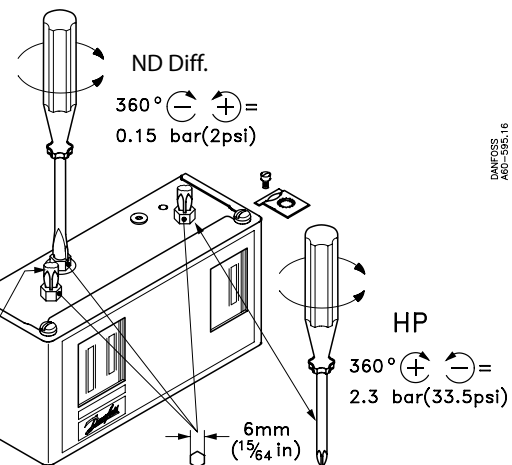

LP  
360°  $\oplus$   $\ominus$  =  
0.7 bar(10psi)



Instruktioner

**KP 15, 15A, 17W, 17B, 17 WB**

KP 15, 17W, 17B, 17 WB: FCKW, FKW, HFCKW  
 KP 15A: R 717 (NH<sub>3</sub>)

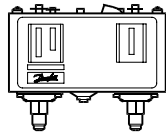
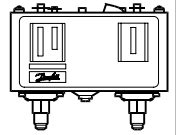

KP 15, 17

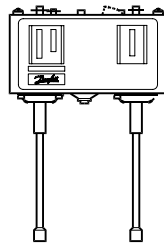

KP 15, 17

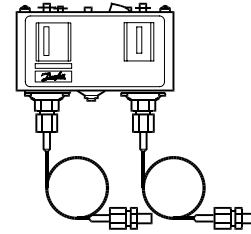

KP 15A

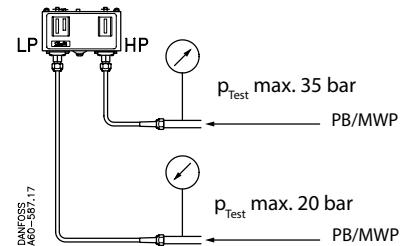
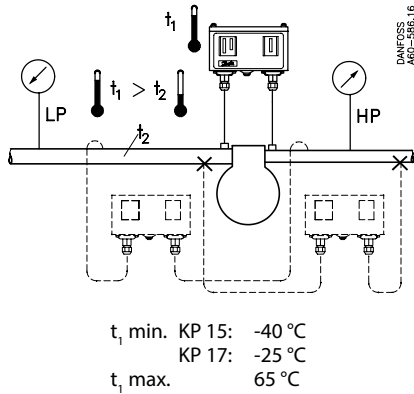

Typen	Reihe	PB	MWP
KP 15	ND: -0,2 →	7,5 bar	250 psi
	HD: 8 →	32 bar	505 psi
KP 15	ND: -0,9 →	7 bar	250 psi
	HD: 8 →	32 bar	35 bar
Reset			
KP 17	ND: -0,2 →	7,5 bar	17 bar
	HD: 8 →	32 bar	35 bar

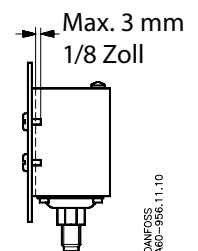
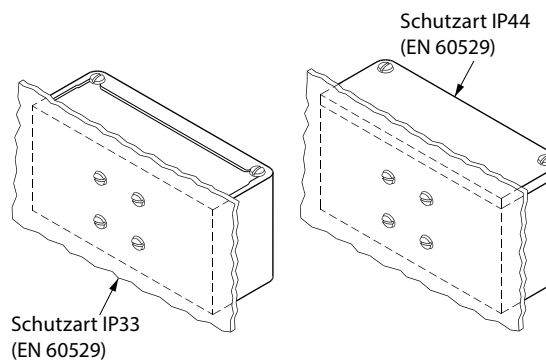
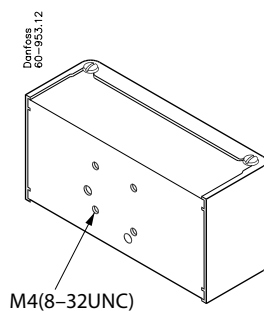
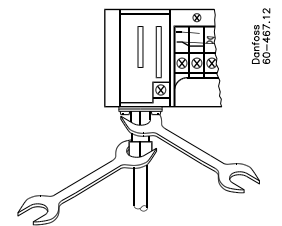
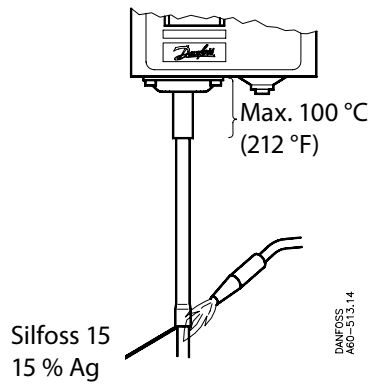
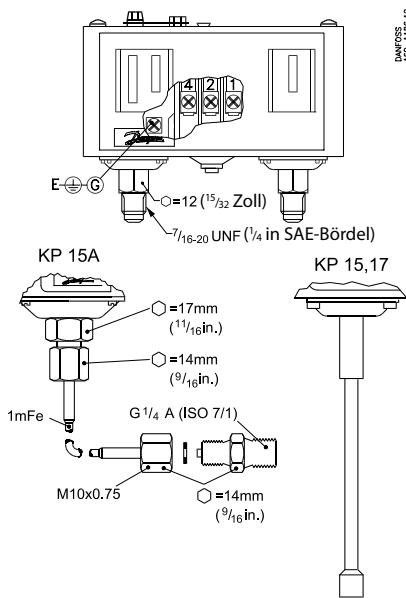

# Instruktioner

## SPDT+ND-Signal

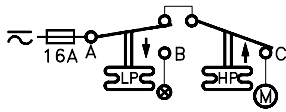

## ND- und HD-Signal

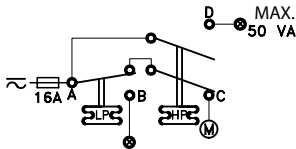

Bei Verwendung gemäß UL-Vorschriften

**UL US Gelistete Kühlstellenregler 61B5**

Kon-takte	Spannung	FL	LR	Wider-stands-last	Pilotan-wendung
A-B	240	8	48	8A	3A
A-C	120	16	96	16A	
	240				12W
A-D	240				50VA

Nur Kupferdraht verwenden  
Anzugsdrehmoment 2,26 Nm

LR 112A	AC1 16 A	400 V~	DC 11
	AC3 16 A		12 W
	AC11 10 A		220 V~

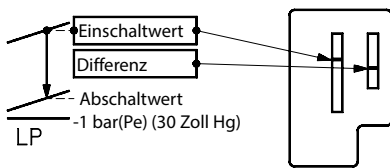

ND, aut. Zurücksetzen

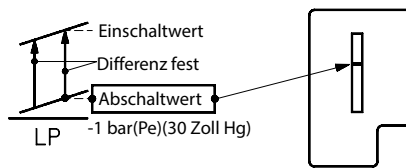

ND, man. Zurücksetzen

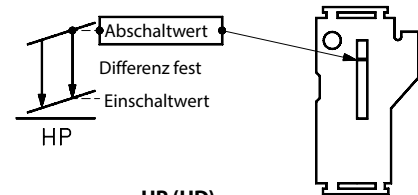

HP (HD)

## Manueller Test

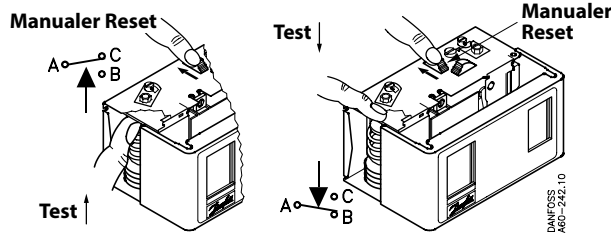

## Umstellbarer Reset KP 15 – ND/HD umstellbar, KP17WB – HD umstellbar

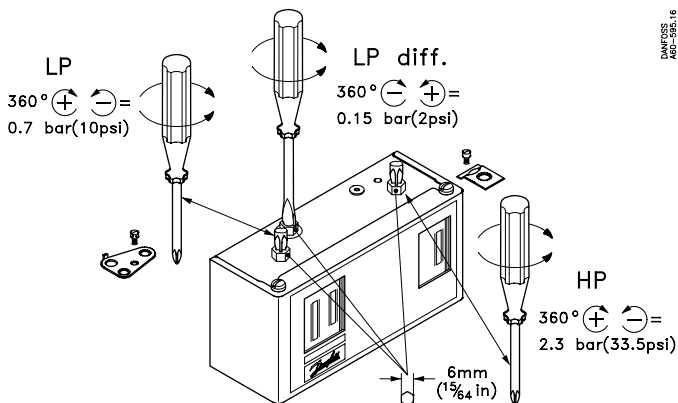
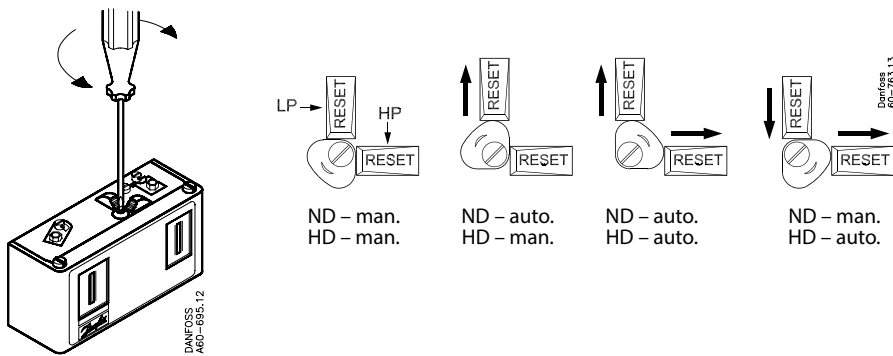

**Instructions**

**Annexe - B, réglages des contacteurs KP**

## KP 15, 15A, 17W, 17B

**SPDT + signal BP**

**Signal BP + HP**

**UL** Régulateur de réfrigération  
c US répertorié 61B5

Contacts	Tension CA	FL c. c.	LR A	Charge résist.	Régime de fonctionnement asservi
A-B	240		8	48	8 A
A-C	120		16	96	16 A
	240				12 W
A-D	240				50 VA

Utiliser uniquement du fil de cuivre  
Couple de serrage 20 lb.in. (2,2 Nm)

Pour une utilisation conforme aux réglementations UL

LR 112A	AC1 16 A	DC 11
	AC3 16 A	12 W
	AC11 10 A	220 V ?

Enclenchement  
Différentiel  
Coupure  
-1 bar(Pe) (762 mm Hg)

BP, réarm. auto

Enclenchement  
Différentiel fixé  
Coupure  
-1 bar(Pe) (762 mm Hg)

BP, réarm. manuel

Coupure  
Différentiel fixé  
Enclenchement

HP

**Réarmement manuel**

Test manuel

**Réarmement manuel**

Test

**Réarmement convertible**  
KP 15 060-1154, 060-1220, 060-1261, 060-1263, 060-1283

Réglages d'usine

BP - man.  
HP - man.

BP - auto  
HP - man.

BP - auto  
HP - auto

BP - man.  
HP - auto

**Réarmement convertible**  
KP 17B 060-539366, 060-539466

BP - auto  
HP - man.

BP - auto  
HP - auto

Diff. BP  
360° ⊖ ⊕ =  
0.15 bar(2psi)

HP  
360° ⊕ ⊖ =  
2.3 bar(33.5psi)

6mm (15/64 in)

LP  
360° ⊕ ⊖ =  
0.7 bar(10psi)

# Instructions

## KP 15, 15A, 17W, 17B, 17 WB

KP 15, 17W, 17B, 17 WB : CFC, HFC, HCFC  
 KP 15A : R 717 (NH<sub>3</sub>)

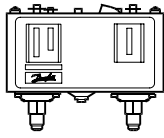
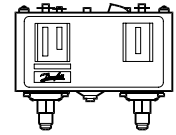

KP 15, 17

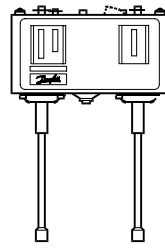

KP 15, 17

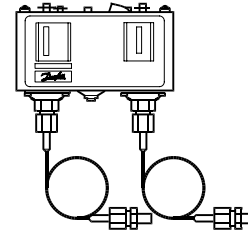

KP 15A

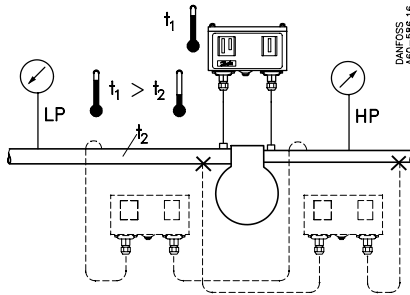

$t_1$  min. KP 15 :  $-40^{\circ}\text{F}$  ( $-40^{\circ}\text{C}$ )  
 KP 17 :  $-25^{\circ}\text{C}$  ( $-13^{\circ}\text{F}$ )  
 $t_1$  max.  $65^{\circ}\text{C}$  ( $150^{\circ}\text{F}$ )

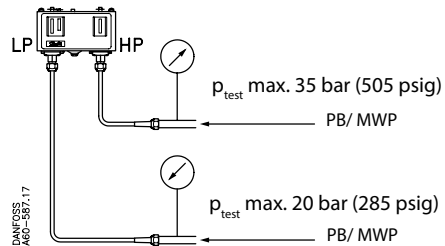

Type	Plage	PB	MWP
KP 15	BP : -0,2 → 7,5 bar	17 bar	250 psi
	HP : 8 → 32 bar	35 bar	505 psi
KP 17	BP : -0,9 → 7 bar	17 bar	250 psi
	HP : 8 → 32 bar	35 bar	505 psi
<b>Réinitialisation</b>			
KP 17	BP : -0,2 → 7,5 bar	17 bar	250 psi
	HP : 8 → 32 bar	35 bar	505 psi

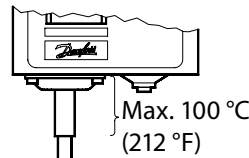
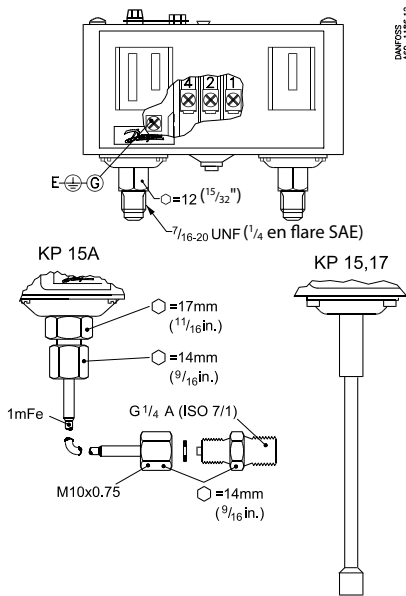

Silfoss 15  
(15 % Ag)

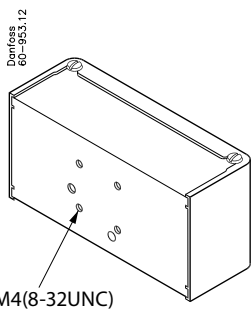
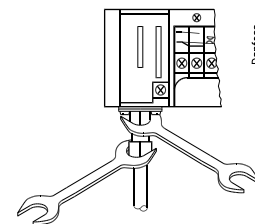

M4(8-32UNC)

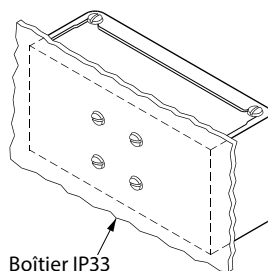

Boitier IP33  
(EN 60529)

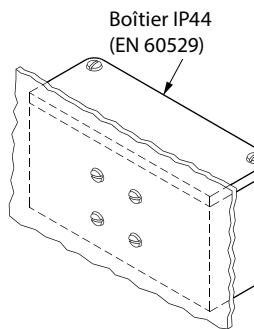

Boitier IP44  
(EN 60529)

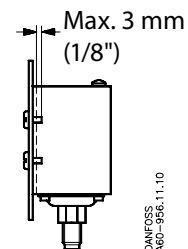

Max. 3 mm  
(1/8")

# Instructions

## SPDT + signal BP

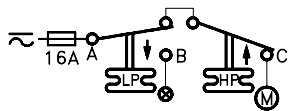

## Signal BP + HP

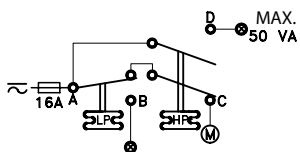

Pour une utilisation conforme aux réglementations UL

**UL** Régulateur de réfrigération répertorié 61B5

Contacts	Tension CA	FL A	LR A	Charge résist.	Régime de fonctionnement asservi
A-B	240	8	48	8A	3A
A-C	120	16	96	16A	
A-C	240				12W
A-D	240				50VA

Utiliser uniquement du fil de cuivre  
Couple de serrage 20 lb.in. (2,2 Nm)

LR 112A	AC1 16 A	400 V~	DC 11
	AC3 16 A		12 W
	AC11 10 A		220 V~

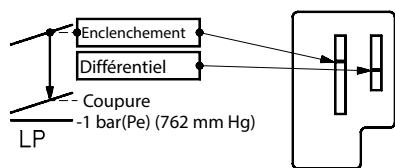

BP, réarm. auto

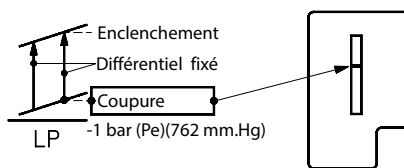

BP, réarm. manuel

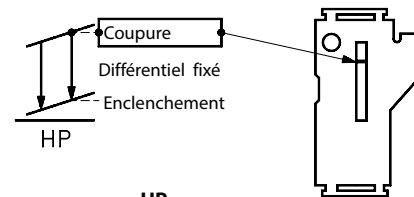

HP

## Test manuel

### Réarmement manuel

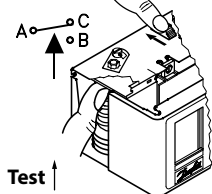

### Test

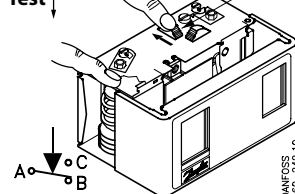

## Réarmement convertible

KP 15 - Convertible BP/HP, KP17WB - Convertible HP

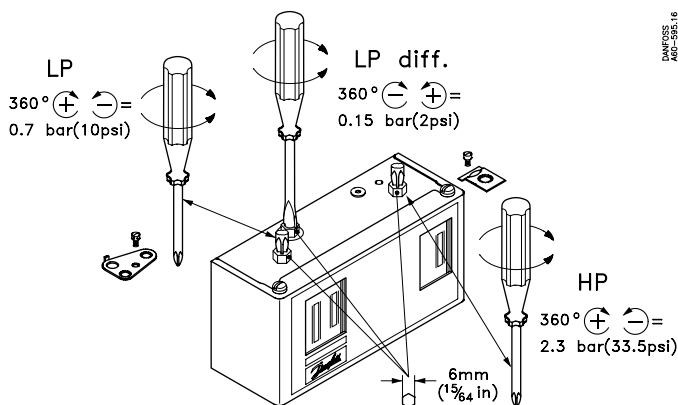
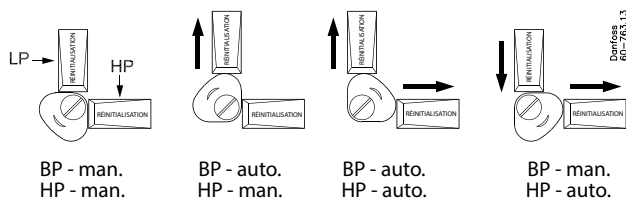
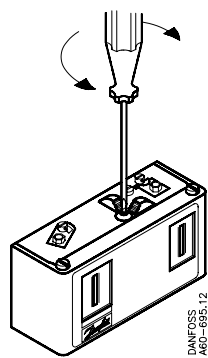

Instrucciones

Anexo B, Ajustes de los interruptores KP

KP 15, 15A, 17W, 17B

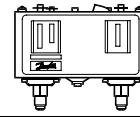

Señal SPDT+LP

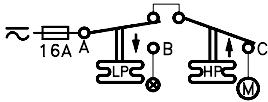

Señal LP y HP

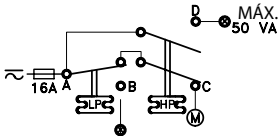

**UL** Controlador de refrigeración listado 61B5

Con-tactos	Tensión CA	FL CC	LR A	Resist. carga	Ciclo de trabajo piloto
A-B	240	8	48	8A	3A
A-C	120	16	96	16A	12W
A-D	240				50VA

Utilice únicamente cable de cobre  
Par de apriete 20 lb in

Para el uso de conformidad con la normativa UL

LR 112A	AC1 16 A	400 V ?	DC 11
	AC3 16 A		12 W
	AC11 10 A		220 V ?

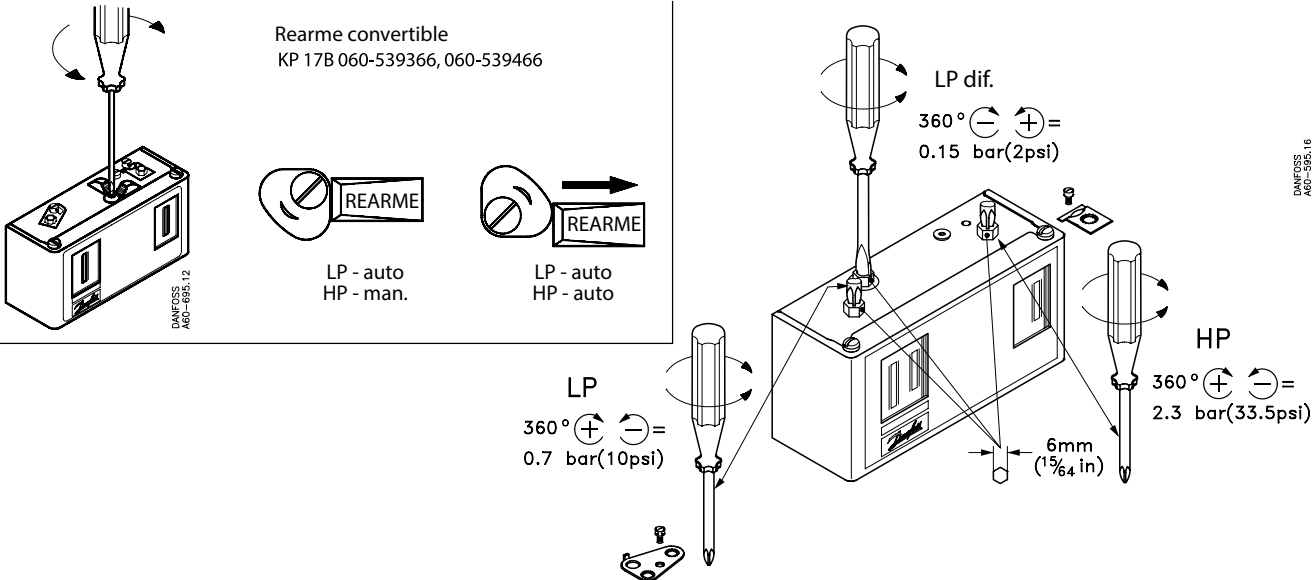
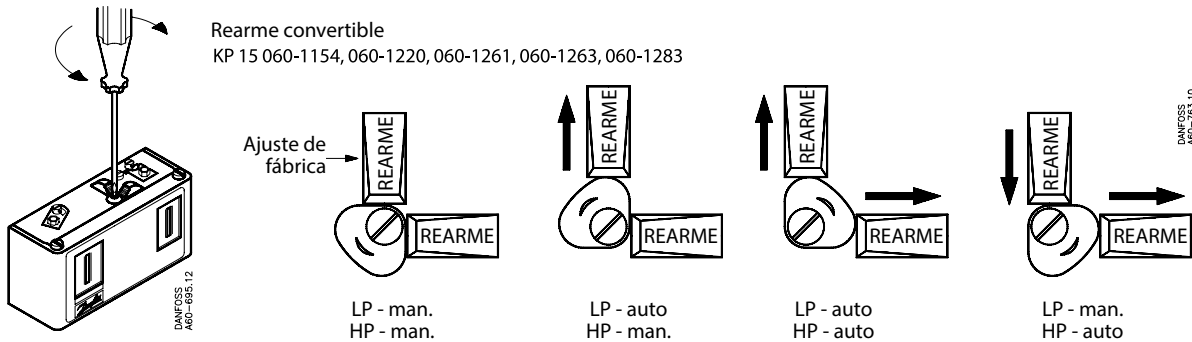
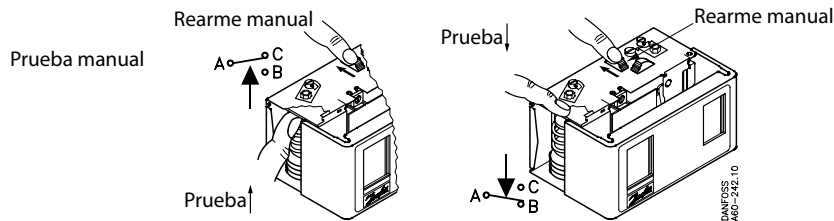
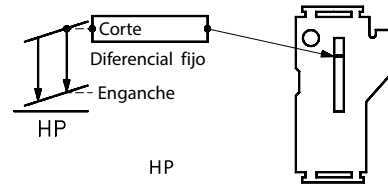
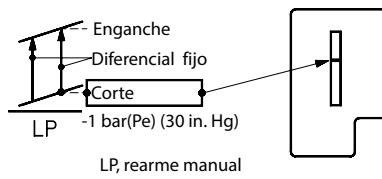
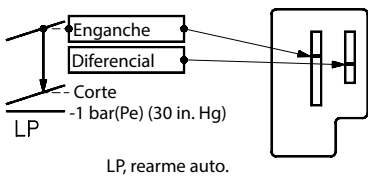

**Instrucciones**

**KP 15, 15A, 17W, 17B, 17 WB**

KP 15, 17W, 17B, 17 WB: CFC, HFC, HCFC  
 KP 15A: R 717 (NH<sub>3</sub>)

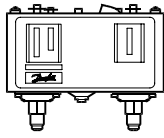
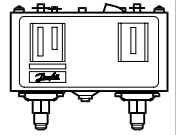

KP 15, 17

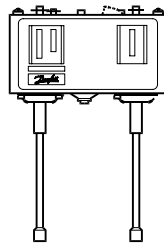

KP 15, 17

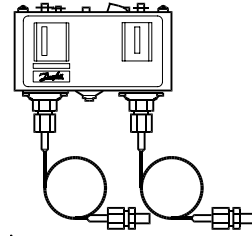

KP 15A

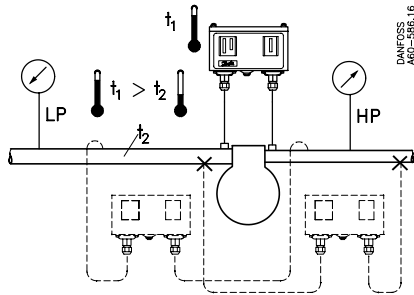

$t_1$  mín. KP 15: -40 °F (-40 °C)  
 KP 17: -25 °C (-13 °F)  
 $t_1$  máx. 65 °C (150 °F)

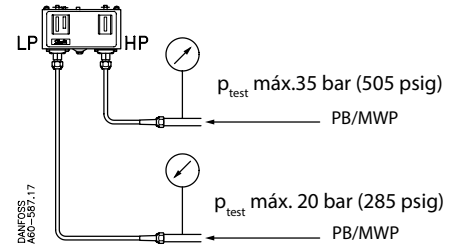

Gama de tipos	Abarcar	PB	MWP
KP 15	LP: -0,2 → 7,5 bar	17 bar	250 psi
	HP: 8 → 32 bar	35 bar	505 psi
KP 15	LP: -0,9 → 7 bar	17 bar	250 psi
	HP: 8 → 32 bar	35 bar	505 psi
Rearme	LP: -0,2 → 7,5 bar	17 bar	250 psi
	HP: 8 → 32 bar	35 bar	505 psi

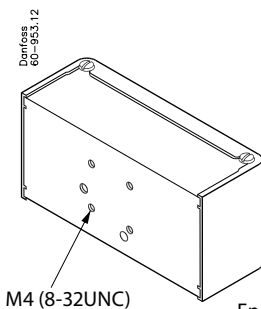
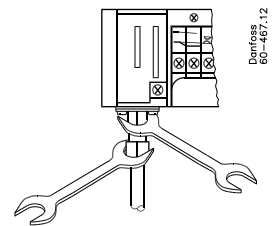
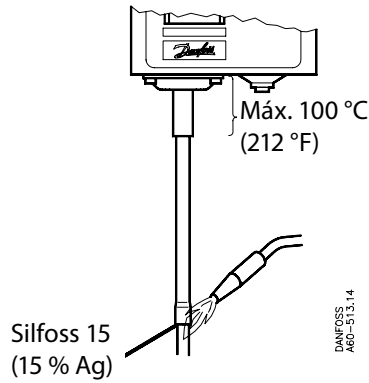
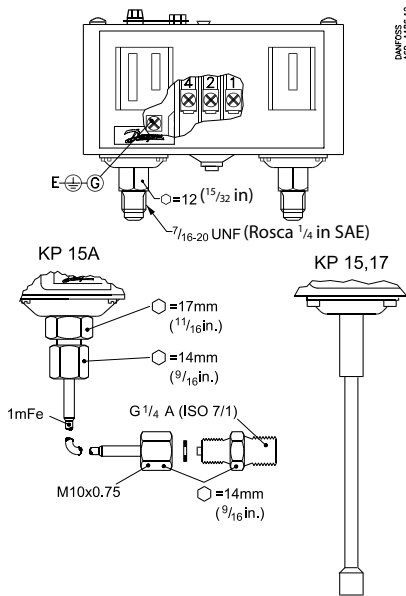

Encapsulamiento IP33 (EN 60529)

Encapsulamiento IP44 (EN 60529)

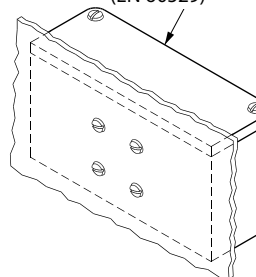

Máx. 3 mm (1/8 in)

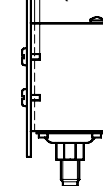

# Instrucciones

## Señal SPDT+LP

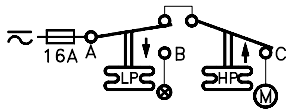

## Señal LP y HP

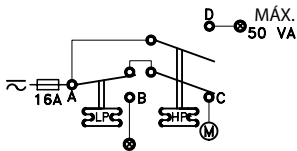

Para el uso de conformidad con la normativa UL

**UL** Refrigeración listada controlador 61B5

Con-tactos	Tensión CA	CC	FL A	LR A	Resist. carga	Ciclo de trabajo piloto
A-B	240		8	48	8A	3A
A-C	120		16	96	16A	
		240				12W
A-D	240					50VA

Utilice únicamente cable de cobre  
Par de apriete 20 lb in

LR 112 A	AC1 16 A	400 V~	CC 11
	AC3 16 A		12 W
	AC11 10 A		220 V~

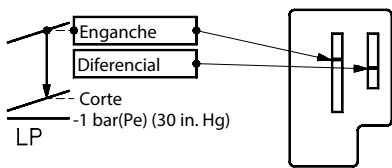

LP, rearme auto.

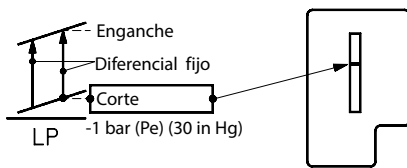

LP, rearme manual

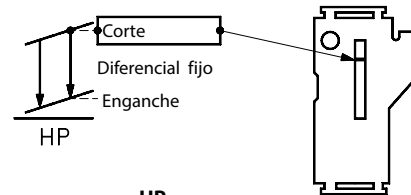

HP

## Prueba manual

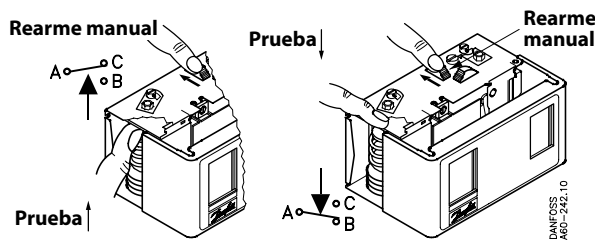

## Rearme convertible

KP 15 - LP/HP convertible, KP17WB - HP convertible

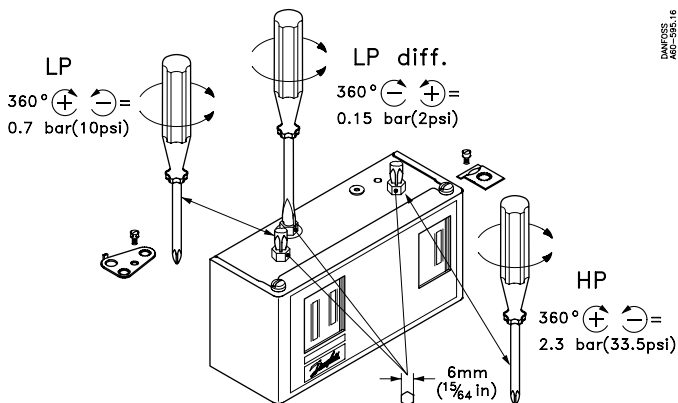
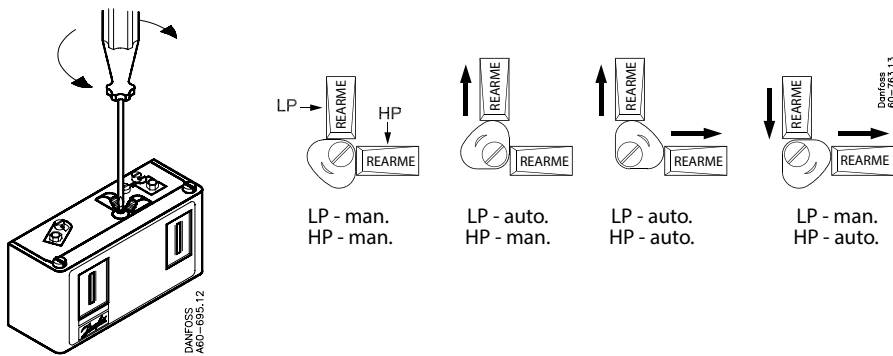



Instruktioner

Bilaga – B, KP-brytarinställningar

## KP 15, 15A, 17W, 17B

SPDT + LP signal

LP- + HP-signal

**UL** Listad kylregulator 61B5

Kontakter	Spänning AC	DC	FL A	LR A	Resist. belastning	Styr. belastning
A-B	240		8	48	8 A	3 A
A-C	120		16	96	16 A	12 W
A-D	240					50 VA

Använd endast koppartråd  
Åtdragningsmoment 20 lb. tum

Vid användning enl. UL-föreskrifter

LR 112A	AC1 16 A	DC 11
	AC3 16 A	12 W
	AC11 10 A	220 V ?

LP, aut. återställ.

LP, man. återställning

HP

Manuell återställning

Manuellt prov

Manuell återställning

Prov

**Konvertibel återställning**  
KP 15 060-1154, 060-1220, 060-1261, 060-1263, 060-1283

Danfoss A60-6935.12

**Konvertibel återställning**  
KP 17B 060-539366, 060-539466

Danfoss A60-5953.10

LP diff. 360° ⊖ ⊕ = 0.15 bar(2psi)

LP 360° ⊕ ⊖ = 0.7 bar(10psi)

HP 360° ⊕ ⊖ = 2.3 bar(33.5psi)

6mm (15/64 in)

Danfoss A60-595.16

# Instruktioner

## KP 15, 15A, 17W, 17B, 17 WB

KP 15, 17W, 17B, 17 WB: CFC, HFC, HCFC  
 KP 15A: R 717 (NH<sub>3</sub>)

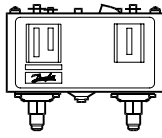
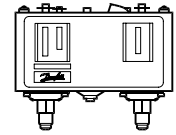

KP 15, 17

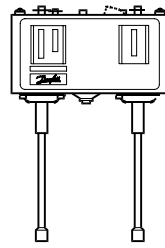

KP 15, 17

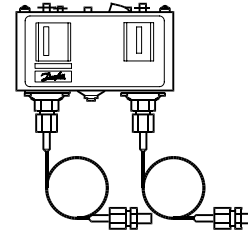

KP 15A

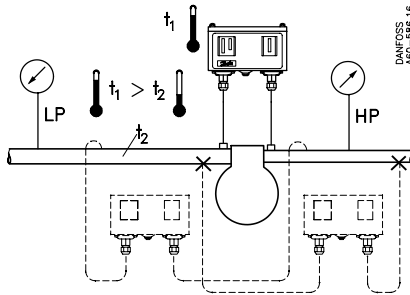

DANFOSS  
 A60-356.16

$t_1$  min. KP 15: -40 °F (-40 °C)  
 KP 17: -25 °C (-13 °F)  
 $t_1$  max. 65 °C (150 °F)

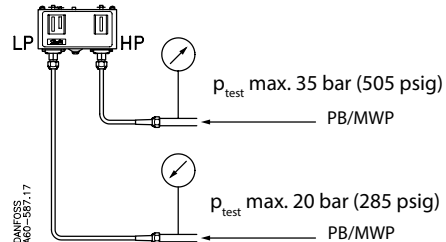

DANFOSS  
 A60-357.17

Typområde	Räckvidd	PB	MWP
KP 15	LP: -0,2 → 7,5 bar	17 bar	250 psi
	HP: 8 → 32 bar	35 bar	505 psi
KP 15	LP: -0,9 → 7 bar	17 bar	250 psi
	HP: 8 → 32 bar	35 bar	505 psi
<b>Återställning</b>			
KP 17	LP: -0,2 → 7,5 bar	17 bar	250 psi
	HP: 8 → 32 bar	35 bar	505 psi

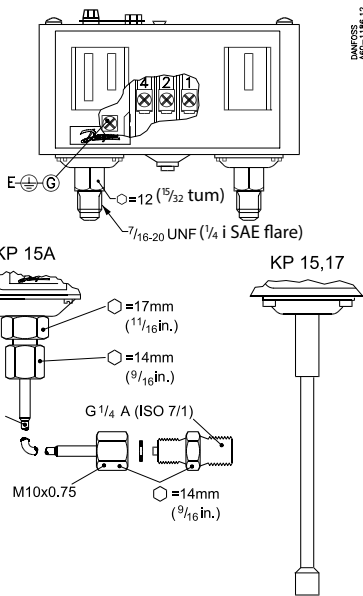

DANFOSS  
 A60-1186.12

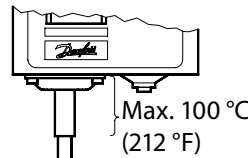

Silfoss 15  
 (15 % Ag)

DANFOSS  
 A60-573.14

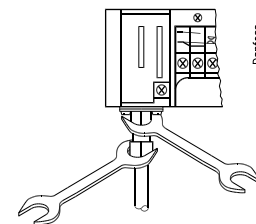

Danfoss  
 60-457.12

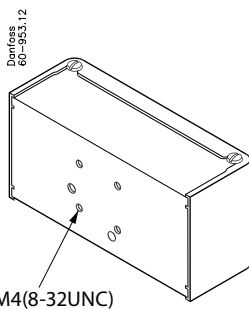

Danfoss  
 60-953.12

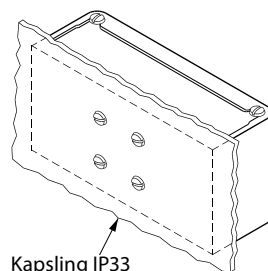

Kapsling IP44  
 (SS-EN 60529)

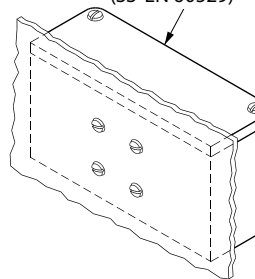

Max. 3 mm  
 (1/8 tum)

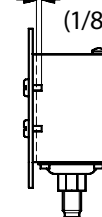

DANFOSS  
 A60-956.11.10

Instruktioner

SPDT + LP signal

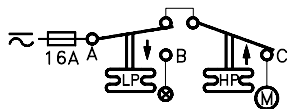

LP- + HP-signal

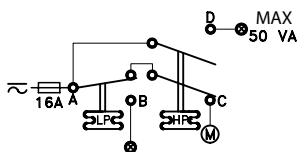

Vid användning enl. UL-föreskrifter

**UL US Listad kylregulator 61B5**

Kon-takter	Spänning	FL	LR	Resist. belastning	Styr-belastning
A-B	240	8	48	8A	3A
A-C	120	16	96	16A	
A-C	240				12W
A-D	240				50VA

LR 112A	AC1 16 A	400 V~	DC 11
	AC3 16 A		12 W
	AC11 10 A		220 V~

Använd endast koppartråd  
Åtdragningsmoment 20 lb. tum

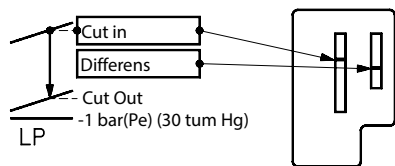

LP, aut. återställning

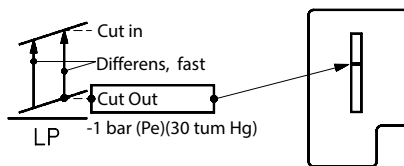

LP, man. återställning

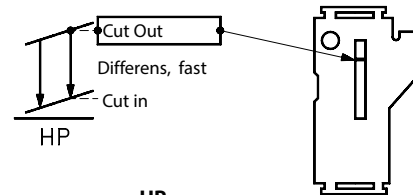

HP

Manuellt prov

Manuell återställning

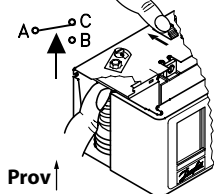

Manuell återställning

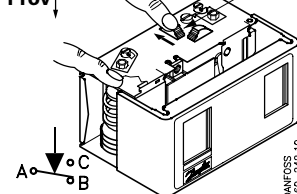

Konvertibel återställning

KP 15 – LP/HP konvertibel, KP17WB – HP konvertibel

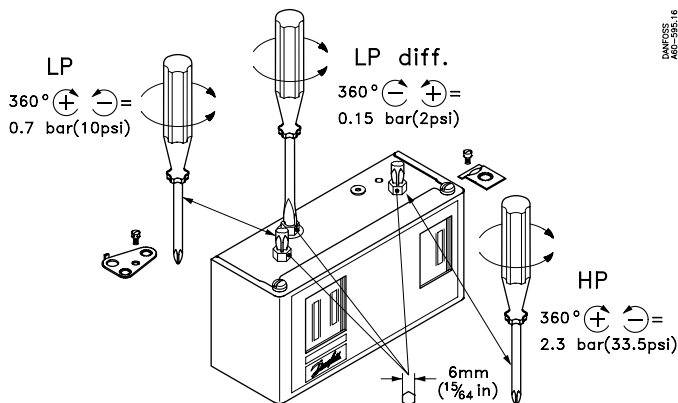
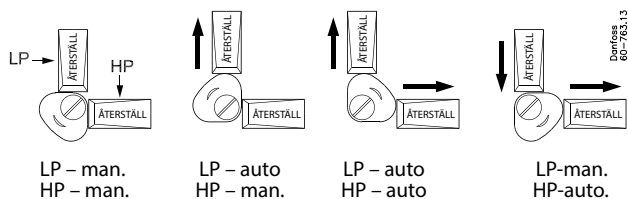
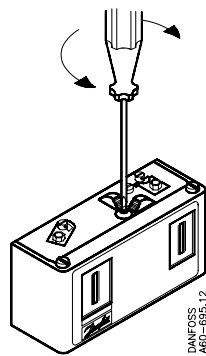

Instructies

Bijlage – B-, KP-schakelaar instellingen

KP 15, 15A, 17W, 17B

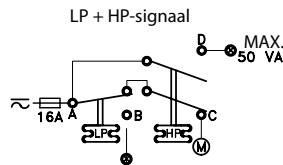
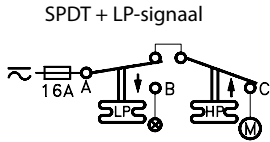
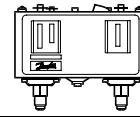

**UL** **us** **Genoemde koelregelaar 61B5**

Con-tacten	Spanning AC	DC	FL A	LR A	Weerst. belasting	Bewak-ingsrelais
A-B	240		8	48	8 A	3 A
A-C	120		16	96	16 A	
		240				12 W
A-D	240					50 VA

Gebruik alleen koperdraad  
Aanhaalmoment 20 lb. in.

Bij gebruik volgens UL-regelgeving

LR 112A	AC1 16 A	DC 11
	AC3 16 A	12 W
	AC11 10 A	220 V ?

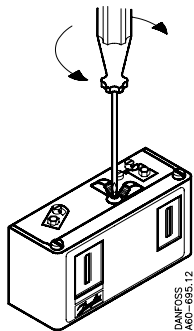
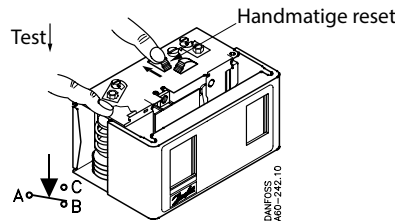
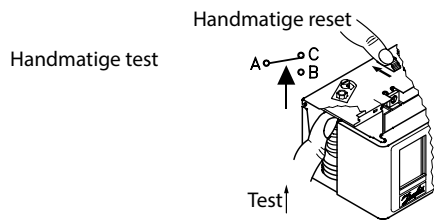
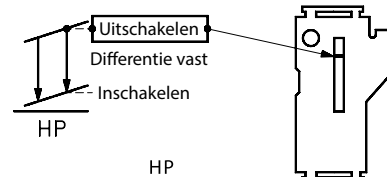
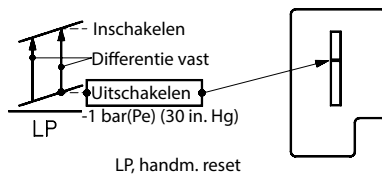
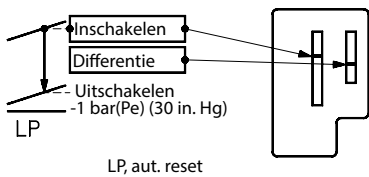

Instelbare reset  
KP 15 060-1154, 060-1220, 060-1261, 060-1263, 060-1283

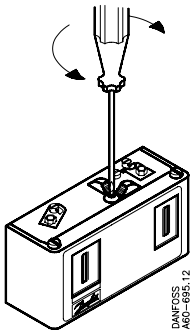
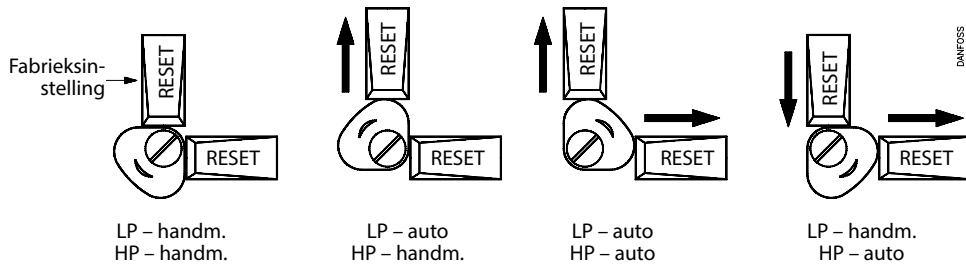

Instelbare reset  
KP 17B 060-539366, 060-539466



LP  
360° (+) (-) =  
0.7 bar (10psi)

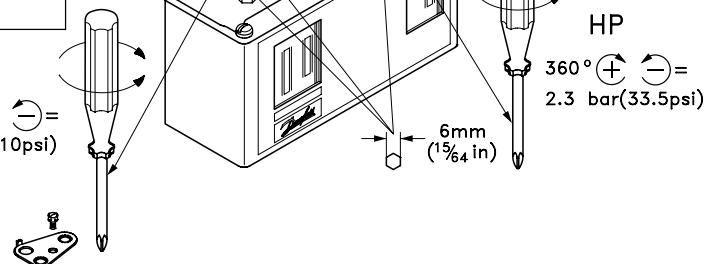

**Instructies**

**KP 15, 15A, 17W, 17B, 17 WB**

KP 15, 17W, 17B, 17 WB: CFC, HFC, HCFC  
 KP 15A: R 717 (NH<sub>3</sub>)

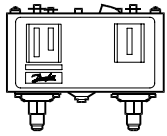
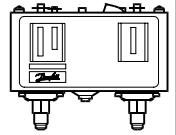

KP 15, 17

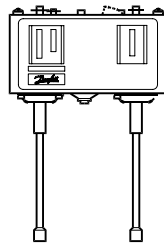

KP 15, 17

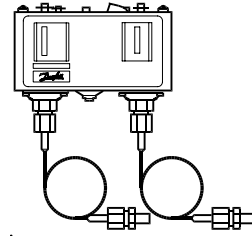

KP 15A

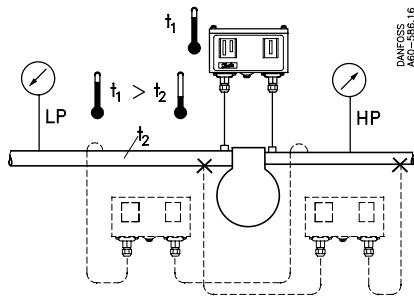

$t_1$  min. KP 15: -40 °F (-40 °C)  
 KP 17: -25 °C (-13 °F)  
 $t_1$  max. 65 °C (150 °F)

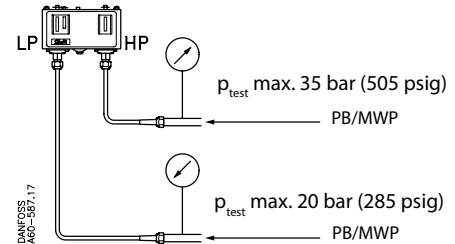

Type	Bereik	PB	MWP
KP 15	LP: -0,2 → 7,5 bar	17 bar	250 psi
	HP: 8 → 32 bar	35 bar	505 psi
KP 15	LP: -0,9 → 7 bar	17 bar	250 psi
	HP: 8 → 32 bar	35 bar	505 psi
Reset KP 17	LP: -0,2 → 7,5 bar	17 bar	250 psi
	HP: 8 → 32 bar	35 bar	505 psi

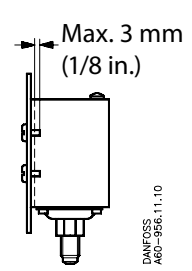
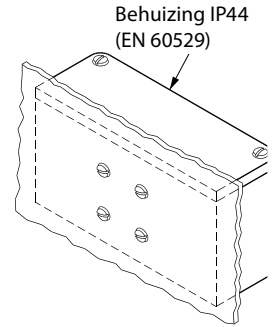
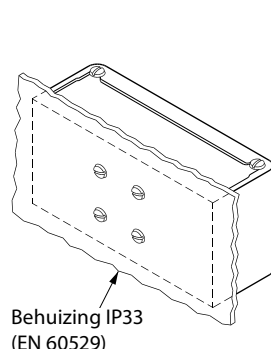
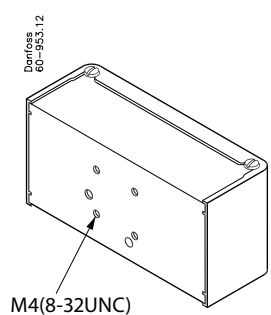
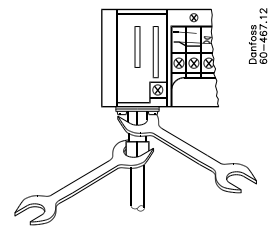
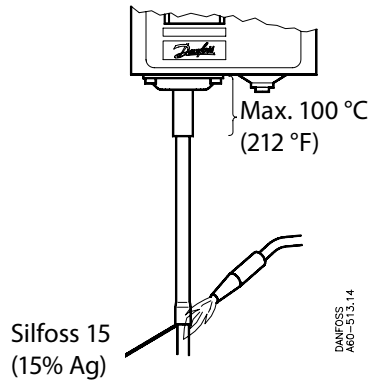
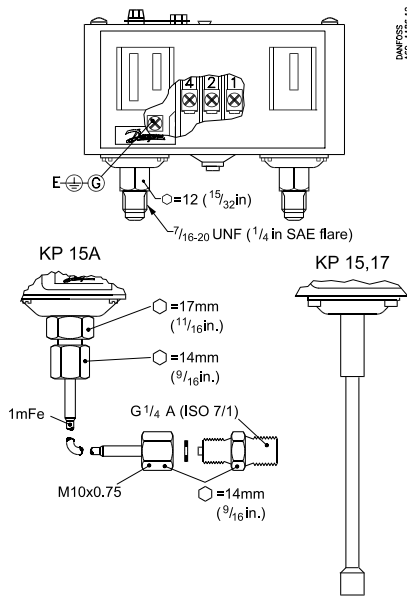

# Instructies

## SPDT + LP-signaal

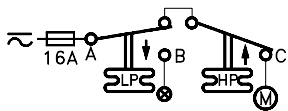

## LP + HP-signaal

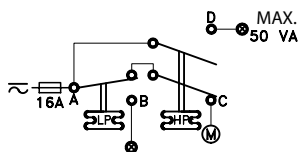

## Bij gebruik volgens UL-regelgeving

**UL US** Genoemde koeling regelaar 61B5

Con-tacten	Spanning	FL	LR	Weerst. belasting	Bewak-ingsrelais
A-B	240 AC	8 A	48 A	8A	3A
A-C	120 AC	16 A	96 A	16A	
		240 DC			12W
A-D	240 AC				50VA

Gebruik alleen koperdraad  
Aanhaalmoment 20 lb. in.

LR 112A	AC1 16 A	400 V~	DC 11
	AC3 16 A		12 W
	AC11 10 A		220 V~

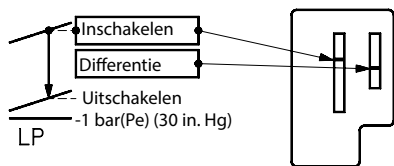

LP, aut. reset

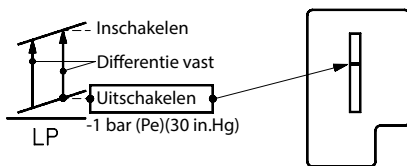

LP, handm. reset

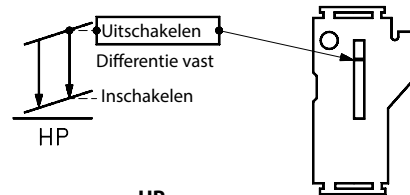

HP

## Handmatige test

### Handmatige reset

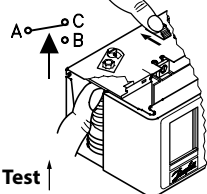

### Test

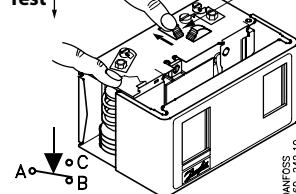

### Handmatige reset

## Converteerbare reset

KP 15 – LP/HP-converteerbaar, KP17WB – HP-converteerbaar

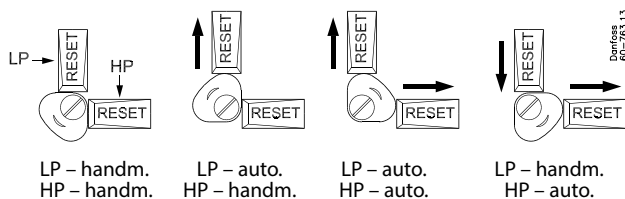
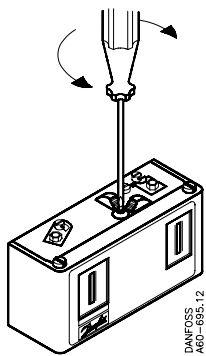

LP  
360° ⊕ ⊖ =  
0.7 bar(10psi)

LP diff.  
360° ⊖ ⊕ =  
0.15 bar(2psi)

HP  
360° ⊕ ⊖ =  
2.3 bar(33.5psi)

6mm  
(15/64 in)

# Ohjeet

## Liite - B, KP-kytkinasetukset

### KP 15, 15A, 17W, 17B

**SPDT + LP signaali**

**LP + HP signaali**

**UL Jäähdytyksen ohjaus 61B5**

Koskettimet	Jännite AC DC	FL A	LR A	Vastuksen kuormitus	Pilottikäyttö
A-B	240	8	48	8 A	3 A
A-C	120	16	96	16 A	12 W
A-D	240				50 VA

Käytä ainoastaan kuparijohtoa  
Kirstymomentti 20 lb. in.

Käytettäessä UL-sääösten mukaisesti

LR 112A	AC1 16 A	DC 11
	AC3 16 A	12 W
	AC11 10 A	220 V ?

**LP, aut. palautus**

**LP, man. palautus**

**HP**

**Manuaalinen palautus**

Manuaalinen testi

**Manuaalinen palautus**

Koe

**Muunneltava palautus**  
KP 15 060-1154, 060-1220, 060-1261, 060-1263, 060-1283

DANFOSS A60-6935.12

**Muunneltava palautus**  
KP 17B 060-539366, 060-539466

DANFOSS A60-595.16

**LP-eroalue**  
360°  $\ominus \oplus$  = 0.15 bar (2psi)

**HP**  
360°  $\oplus \ominus$  = 2.3 bar (33.5psi)

6mm (15/64 in)

# Ohjeet

## KP 15, 15A, 17W, 17B, 17 WB

KP 15, 17W, 17B, 17 WB: CFC, HFC, HCFC  
 KP 15A: R 717 (NH<sub>3</sub>)

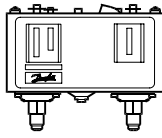
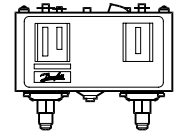

KP 15, 17

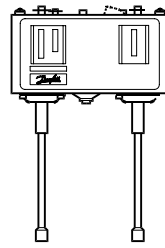

KP 15, 17

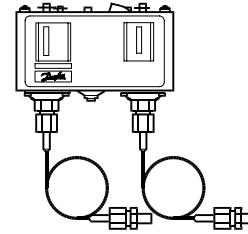

KP 15 A

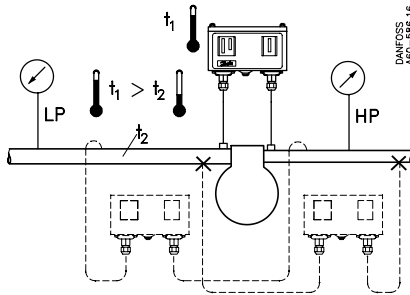

DANFOSS  
A60-356.16

t<sub>1</sub> min. KP 15: -40 °F (-40 °C)  
 KP 17: -25 °C (-13 °F)  
 t<sub>1</sub> maks. 65 °C (150 °F)

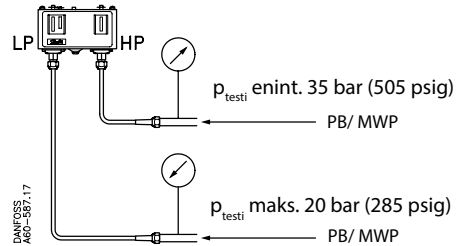

Tyyppi	Alue	PB	MWP
KP 15	LP: -0,2 → 7,5 bar	17 bar	250 psi
	HP: 8 → 32 bar	35 bar	505 psi
KP 15	LP: -0,9 → 7 bar	17 bar	250 psi
	HP: 8 → 32 bar	35 bar	505 psi
Palautus KP 17	LP: -0,2 → 7,5 bar	17 bar	250 psi
	HP: 8 → 32 bar	35 bar	505 psi

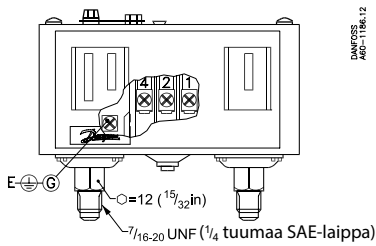

DANFOSS  
A60-1186.12

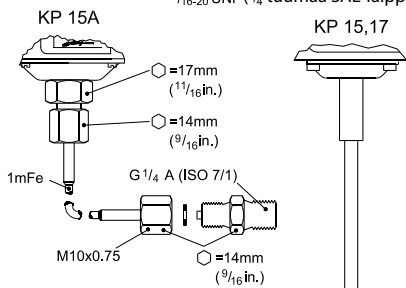

KP 15A

KP 15, 17

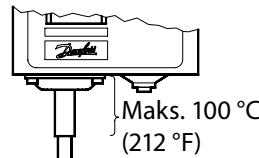

Maks. 100 °C  
(212 °F)

Silfoss 15  
(15 % Ag)

DANFOSS  
A60-5731.14

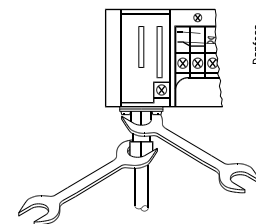

Danfoss  
60-467.12

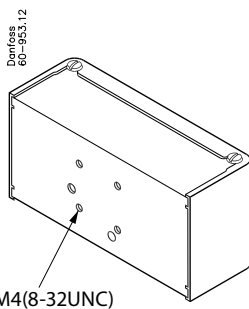

M4(8-32UNC)

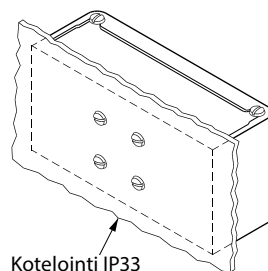

Kotelointi IP33  
(EN 60529)

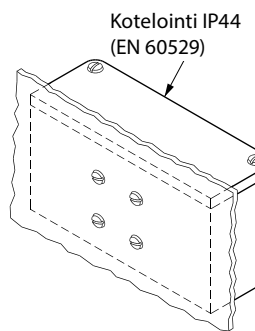

Kotelointi IP44  
(EN 60529)

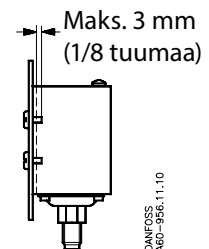

Maks. 3 mm  
(1/8 tuumaa)

DANFOSS  
A60-956.11.10



Ohjeet

SPDT + LP signaali

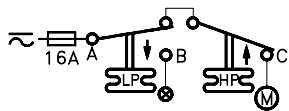

LP + HP signaali

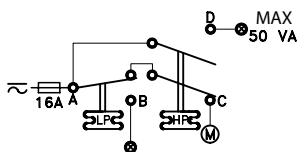

Käytettäessä UL-säädösten mukaisesti

**UL** Luettelon mukainen  
jäähdytys säädin 61B5

Kosket- timet	Jännite AC DC	FL A	LR A	Vastuksen kuormitus	Pilotti- käyttö
A-B	240	8	48	8 A	3 A
A-C	120	16	96	16 A	
	240				12 W
A-D	240				50 VA

LR 112A	AC1 16 A	400 V~	DC 11
	AC3 16 A		12 W
	AC11 10 A		220 V~

Käytä ainoastaan kuparijohtoa  
Kiristysmomentti 20 lb. in.

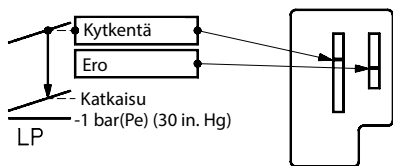

LP, aut. palautus

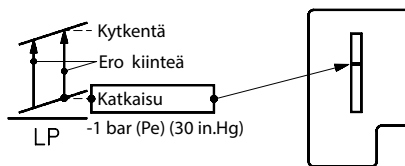

LP, man. palautus

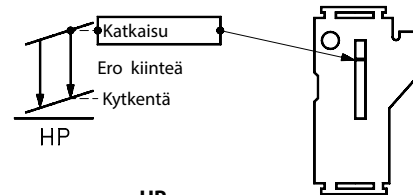

HP

Manuaalinen testi

Manuaalinen palautus

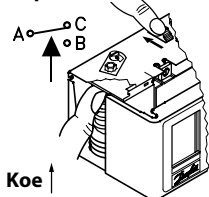

Koe ↓

Manuaalinen palautus

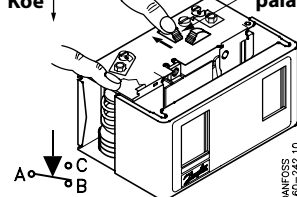

DANFOSS  
A60-242.10

Muunneltava palautus

KP 15 - LP/HP muunneltava, KP17WB - HP muunneltava

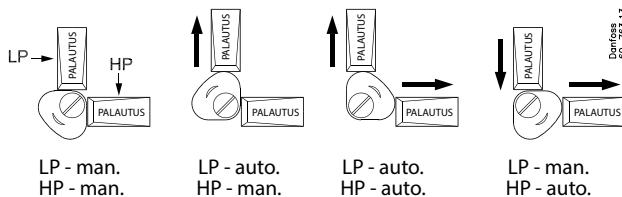
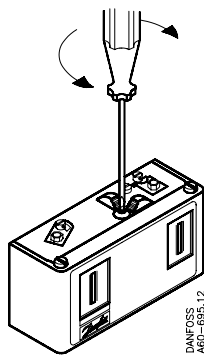

Danfoss  
60-763.13

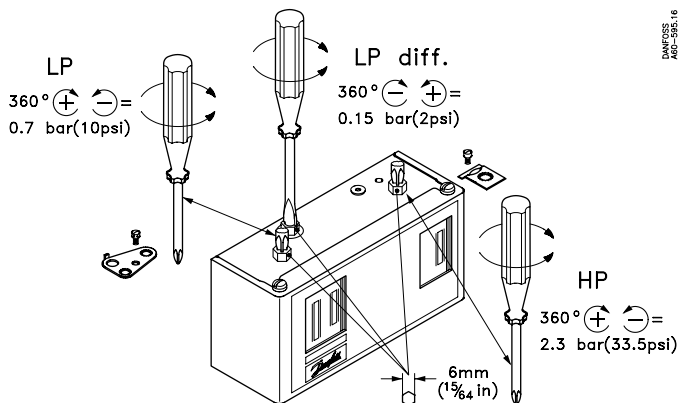

DANFOSS  
A60-382.16

التعليمات

KP 15. 15A. 17W. 17B. 17 WB

KP 15, 17W, 17B, 17 WB: CFC, HFC, HCFC  
(KP 15A: R 717 (NH<sub>3</sub>))

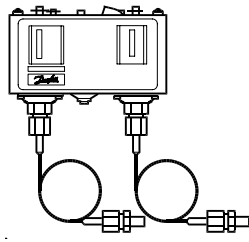
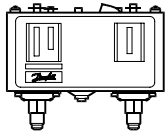

KP 15A

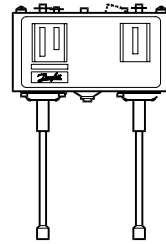

KP 15, 17

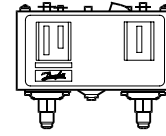

KP 15, 17

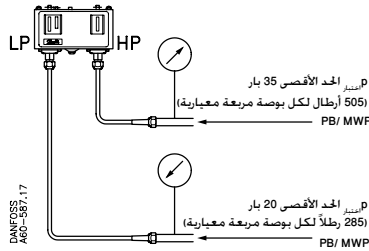

المدخل	النطاق	المدخل	المدخل	النوع
MWP	PB			
250 رطال لكل بوصة مربعة	17 بار	7.5 بار	← LP: -0.2	KP 15
505 (رطال لكل بوصة مربعة معيارية)	35 بار	32 بار	← HP: 8	
250 رطال لكل بوصة مربعة	17 بار	7 بار	← LP: -0.9	KP 15
505 (رطال لكل بوصة مربعة معيارية)	35 بار	32 بار	← HP: 8	
إعادة الضغط				
250 رطال لكل بوصة مربعة	17 بار	7.5 بار	← LP: -0.2	KP 17
505 (رطال لكل بوصة مربعة معيارية)	35 بار	32 بار	← HP: 8	

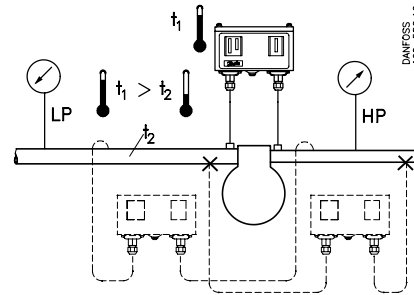

الحد الأدنى KP 15: 40- درجة فهرنهايت (40- درجة مئوية)  
KP 17: 25- درجة مئوية (13- درجة فهرنهايت)  
الحد الأقصى: 65 درجة مئوية (150 درجة فهرنهايت)

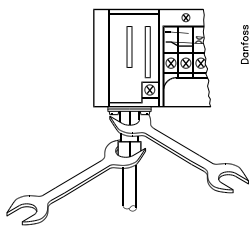

Danfoss 60-467.12

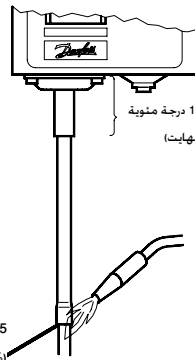

Silfoss 15  
(Ag 15%)

الحد الأقصى 100 درجة مئوية  
(212 درجة فهرنهايت)

DANFOSS  
A60-513.1.4

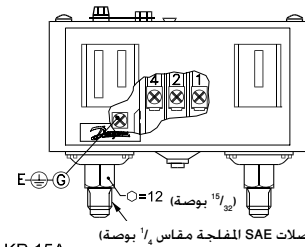

DANFOSS  
A60-1186.12

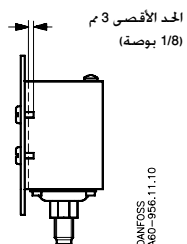
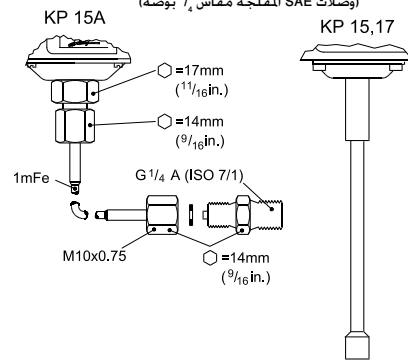

DANFOSS  
A60-356.11.10

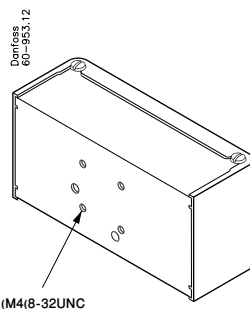

(M4x8-32UNC)

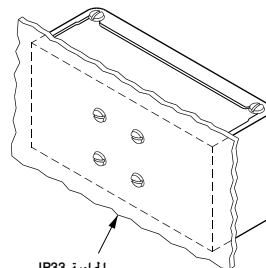

الخلاوة IP33  
(EN 60529)

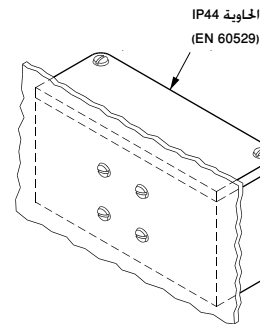

الخلاوة IP44  
(EN 60529)





Instructions

Annex - C,

Wiring drawing / Ledningstegning / Schaltplan / schéma de câblage / Diagrama eléctrico / Kabeldragning / Bedradingstekening / KytKentäkaavio / الملحق "ج"، مخطط توصيلات الأسلاك

Standard power supply description and wiring diagram  
 Standardbeskrivelse af strømforSyning og ledningsdiagram  
 Beschreibung der Standard-Versorgungsspannung und Schaltplan  
 Description de l'alimentation électrique standard et schéma de câblage  
 Standardbeskrivelse af strømforSyning og ledningsdiagram  
 Beskrivning av standardströmtillförsel och kopplingschema  
 Standaard voeding en bedradingsschema  
 Vakiovirtalähteen kuvaus ja kytkentäkaavio  
 وصف قياسي لمصدر الطاقة ومخطط توصيل الأسلاك

220 V for R452A, R134a, R404A/R507, UL and none UL  
 115 V for R134a, R404A/R507, UL and none UL

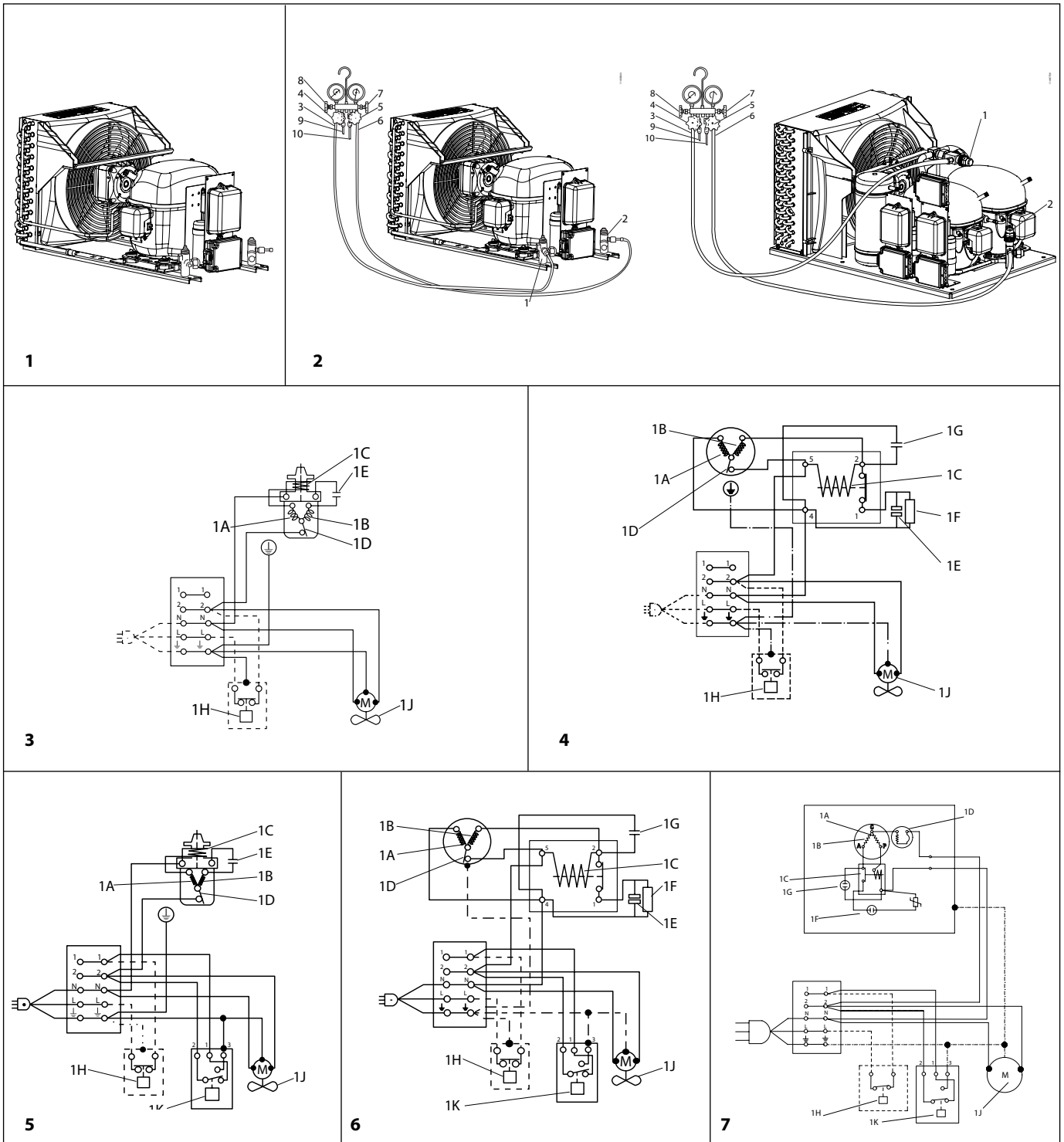

# Instructions

## Twin compressor / Dobbelt kompressor / Twin-Verdichter / Compresseur double / Compressor doble / Twin kompressor / Dubbele compressor / Kaksoiskompressorit /

الضاغط المزدوج

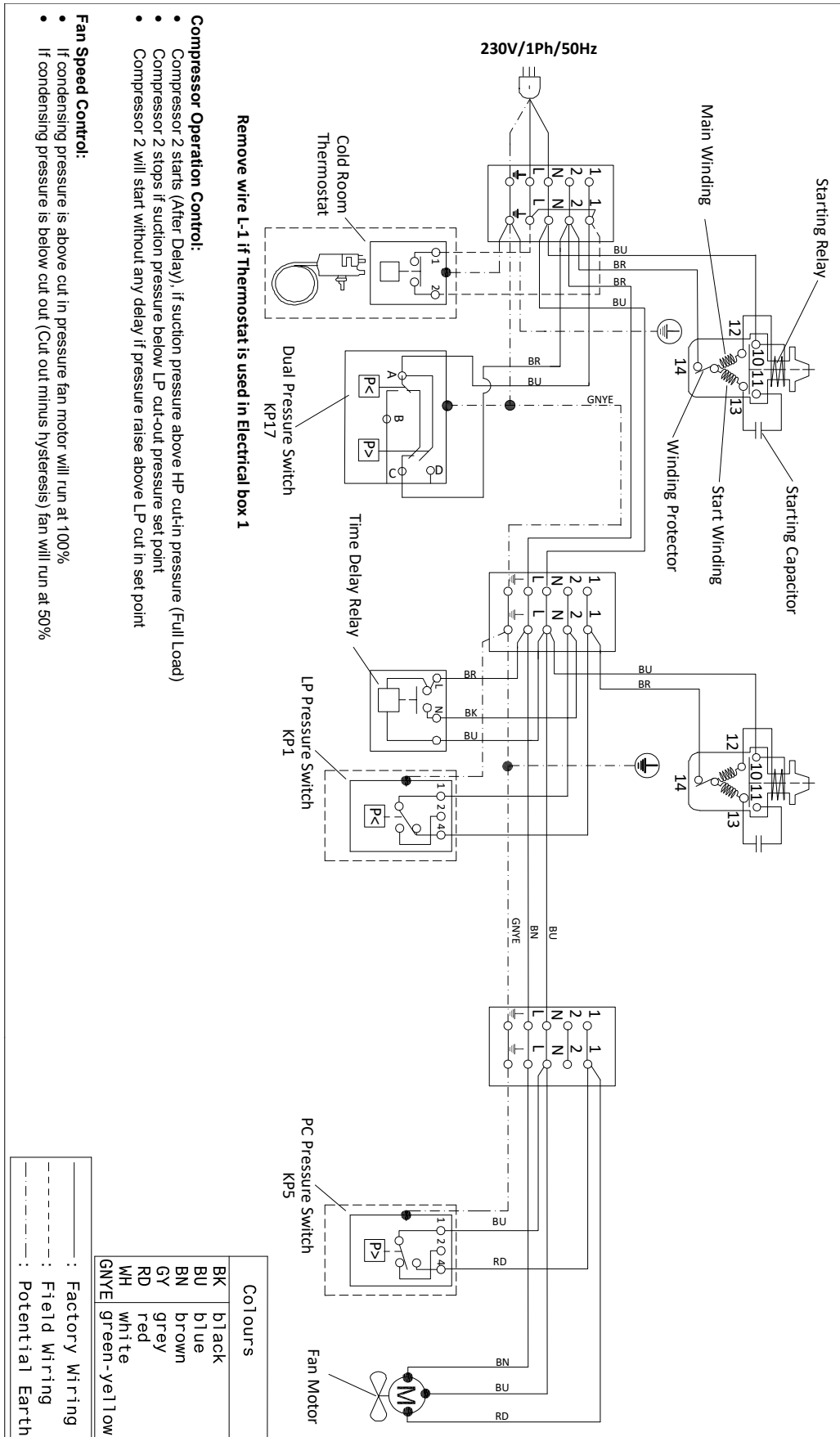

Instructions

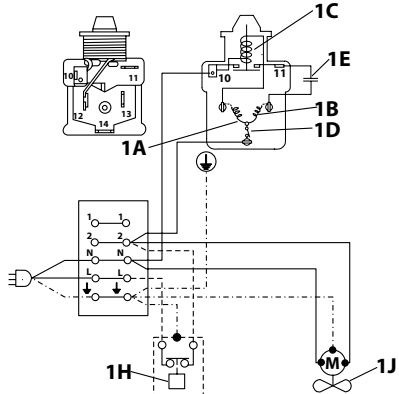

9

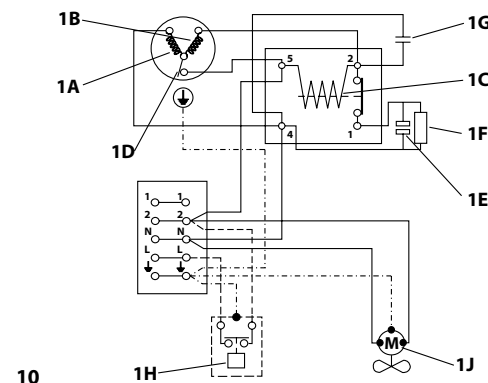

10

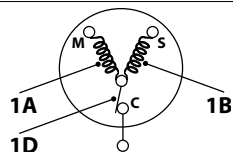

12

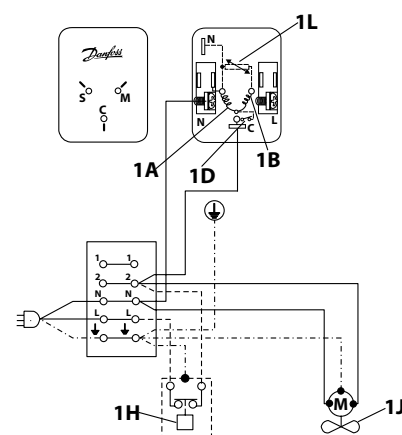

11

Compressor range: NS34

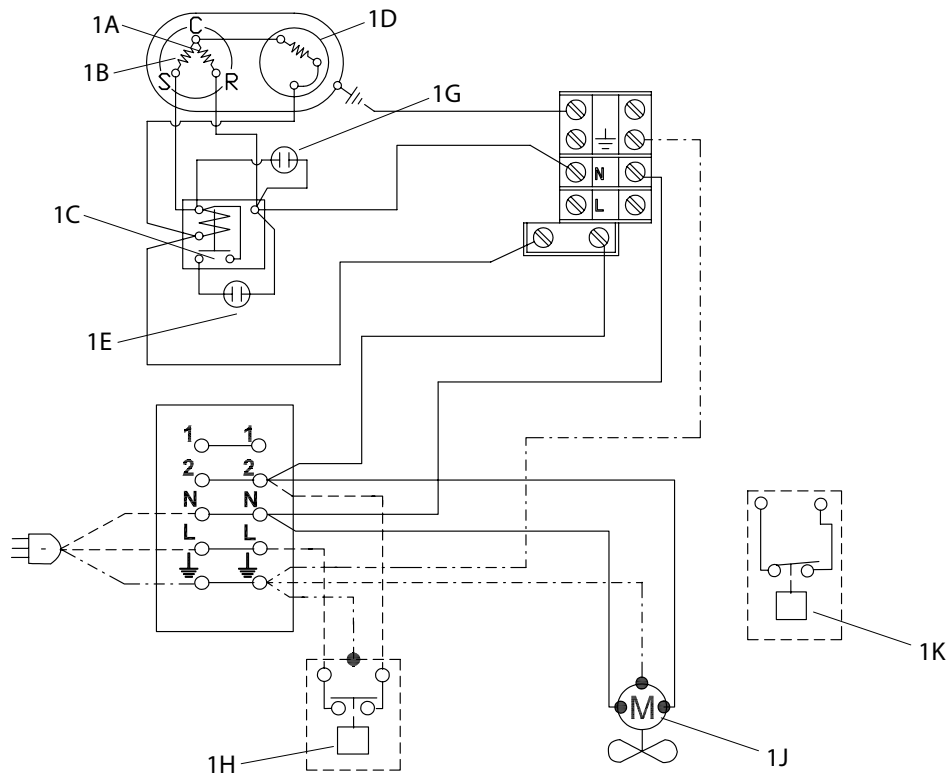

13

## Instructions

### Compressor range: NL, NP, NU and NX

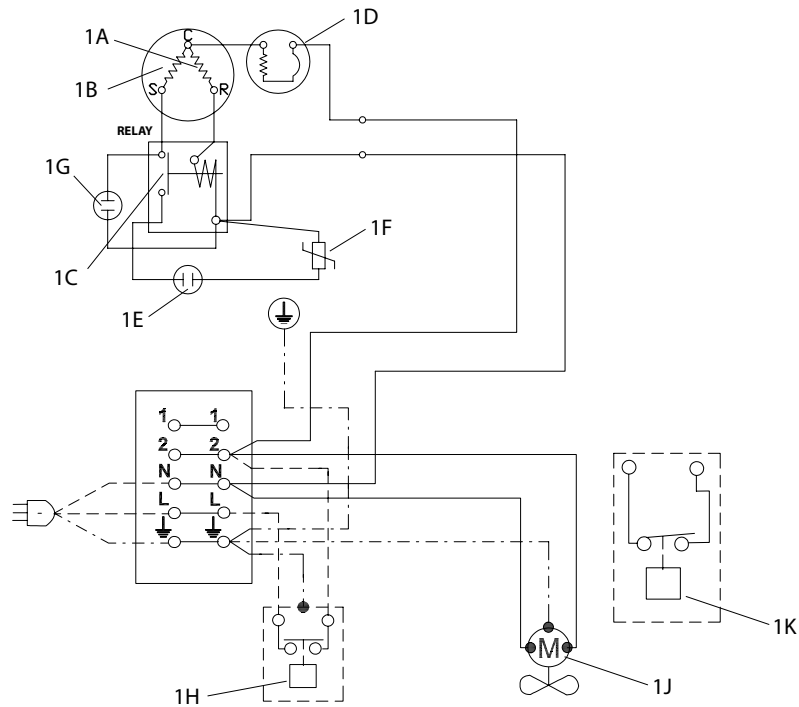

14

### Compressor range: NBC30

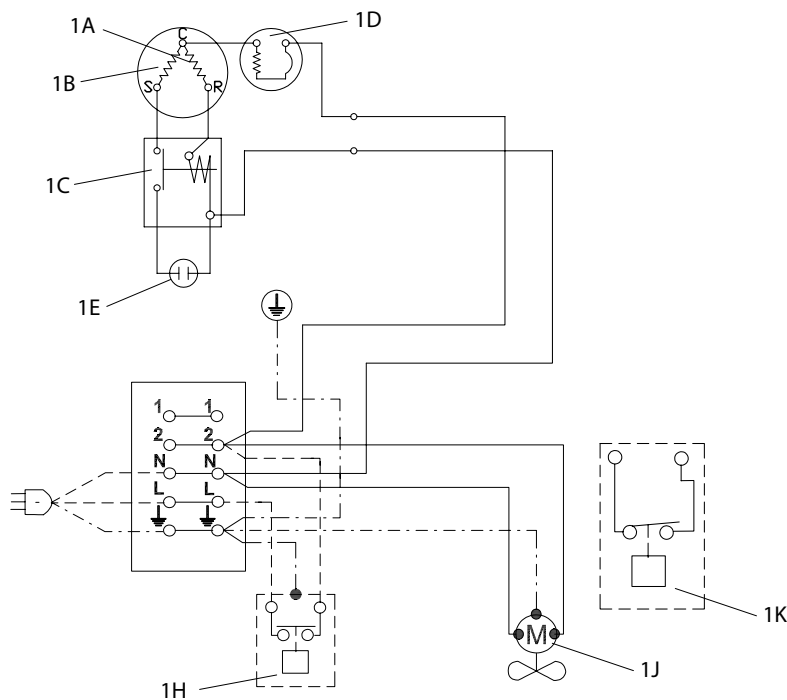

15

#### English legend

1A - Main winding  
1B - Start winding  
1C - Start relay  
1D - Winding protector  
1E - Start capacitor  
1F - NTC  
1G - Run capacitor  
1H - Thermostat  
1J - Fan  
1K - Pressure control  
CP1 - Compressor 1  
CP2 - Compressor 2  
D - Bridge or Time Delay  
P - Pressostat  
T - Bridge or Thermostat

#### Dansk forklaring

1A - Hovedvikling  
1B - Startvikling  
1C - Startrelæ  
1D - Viklingsbeskytter  
1E - Startkondensator  
1F - NTC  
1G - Driftskondensator  
1H - Termostat  
1J - Ventilator  
1K - Pressostat  
CP1 - Kompressor 1  
CP2 - Kompressor 2  
D - Bro- eller tidsforsinkelse  
P - Pressostat  
T - Bro eller termostat

#### Deutsche Legende

1A - Hauptwicklung  
1B - Startwicklung  
1C - Startrelais  
1D - Wicklungsschutz  
1E - Anlaufkondensator  
1F - NTC  
1G - Betriebskondensator  
1H - Thermostat  
1J - Lüfter  
1K - Druckschalter  
CP1 - Verdichter 1  
CP2 - Verdichter 2  
D - Brücke oder Zeitverzögerung  
P - Pressostat  
T - Brücke oder Thermostat

#### Légende en français

1A - Enroulement principal  
1B - Enroulement de démarrage  
1C - Relais de démarrage  
1D - Protection de l'enroulement interne  
1E - Condensateur de démarrage  
1F - NTC  
1G - Condensateur de marche  
1H - Thermostat  
1J - Ventilateur  
1K - Régulateur de pression  
CP1 - Compresseur 1  
CP2 - Compresseur 2  
D - Pont ou temporisation  
P - Pressostat  
T - Pont ou thermostat



**Leyenda en Español**

1A - Devanado principal  
 1B - Devanado de arranque  
 1C - Relé de arranque  
 1D - Protector del devanado  
 1E - Condensador de arranque  
 1F - NTC  
 1G - Condensador de marcha  
 1H - Termostato  
 1J - Ventilador  
 1K - Control de presión  
 CP1 - Compresor 1  
 CP2 - Compresor 2  
 D - Puente o retardo de tiempo  
 P - Presostato  
 T - Puente o termostato

**Svensk förklaring**

1A - Huvudlindning  
 1B - Startlindning  
 1C - Startrelä  
 1D - Lindningsskydd  
 1E - Startkondensator  
 1F - NTC  
 1G - Drivkondensator  
 1H - Termostat  
 1J - Fläkt  
 1K - Pressostat  
 CP1 - kompressor 1  
 CP2 - kompressor 2  
 D - Brygga eller tidsfördröjning  
 P - Pressostat  
 T - Brygga eller termostat

**Nederlandse legenda**

1A - Hoofdwikkeling  
 1B - Startwikkeling  
 1C - Startrelais  
 1D - Wickelbeveiliging  
 1E - Startcondensator  
 1F - NTC  
 1G - Bedrijfscondensator  
 1H - Thermostaat  
 1J - Ventilator  
 1K - Pressostaat  
 CP1 - Compressor 1  
 CP2 - Compressor 2  
 D - Brug of tijdvertraging  
 P - Pressostaat  
 T - Brug of thermostaat

**Suomi Legenda**

1A - Pääkäämi  
 1B - Käynnistyskäämi  
 1C - Käynnistysrele  
 1D - Käämisuoja  
 1E - Käynnistyskondensaattori  
 1F - NTC  
 1G - Käyntikondensaattori  
 1H - Termostaatti  
 1J - Puhallin  
 1K - Paineen ohjaus  
 CP1 - Kompessor 1  
 CP2 - Kompessor 2  
 D - Silta tai aikaviive  
 P - Painekeytkin  
 T - Silta tai termostaatti

**العربية**

1A - الملف اللولبي الرئيسي  
 1B - بدء الملف اللولبي  
 1C - بدء المرحل  
 1D - واقى الملف اللولبي  
 1E - بدء المكثف  
 NTC - 1F  
 1G - مكثف التشغيل  
 1H - منظم الحرارة  
 1J - المروحة  
 1K - عنصر التحكم في الضغط  
 CP1 - الضاغط 1  
 CP2 - الضاغط 2  
 D - الجسر أو التأخر الزمني  
 Pressostat - P  
 T - الجسر أو منظم الحرارة

**Danfoss A/S**

Climate Solutions • danfoss.com • +45 7488 2222

Any information, including, but not limited to information on selection of product, its application or use, product design, weight, dimensions, capacity or any other technical data in product manuals, catalogues descriptions, advertisements, etc. and whether made available in writing, orally, electronically, online or via download, shall be considered informative, and is only binding if and to the extent, explicit reference is made in a quotation or order confirmation. Danfoss cannot accept any responsibility for possible errors in catalogues, brochures, videos and other material. Danfoss reserves the right to alter its products without notice. This also applies to products ordered but not delivered provided that such alterations can be made without changes to form, fit or function of the product.

All trademarks in this material are property of Danfoss A/S or Danfoss group companies. Danfoss and the Danfoss logo are trademarks of Danfoss A/S. All rights reserved.